

**Catalog
of
Optoelectronic
Products
November, 1977**

Monsanto Commercial Products Co.
Electronics Division
3400 Hillview Avenue
Palo Alto, Calif. 94304
Tel: (415) 493-3300
TWX: (910) 373-1767

Copyright © 1977 by Monsanto Company.
All rights reserved. No part of this book may be
reproduced without the written permission of
Monsanto Company.

WARRANTY AND LIABILITY DISCLAIMER

The material contained herein is for informational purposes only. Nothing contained herein is to be construed as a recommendation to use any product in conflict with any patent and Monsanto makes no representations or warranties, express or implied, that such products do not infringe on any patent. In addition, **Monsanto makes no representations or warranties, express or implied, as to merchantability or fitness for particular purpose of any products referred to**, no guarantee of satisfactory results from reliance upon contained information or recommendations, and disclaims all liability for any resulting loss or damage.

ALL SPECIFICATIONS SUBJECT TO CHANGE.

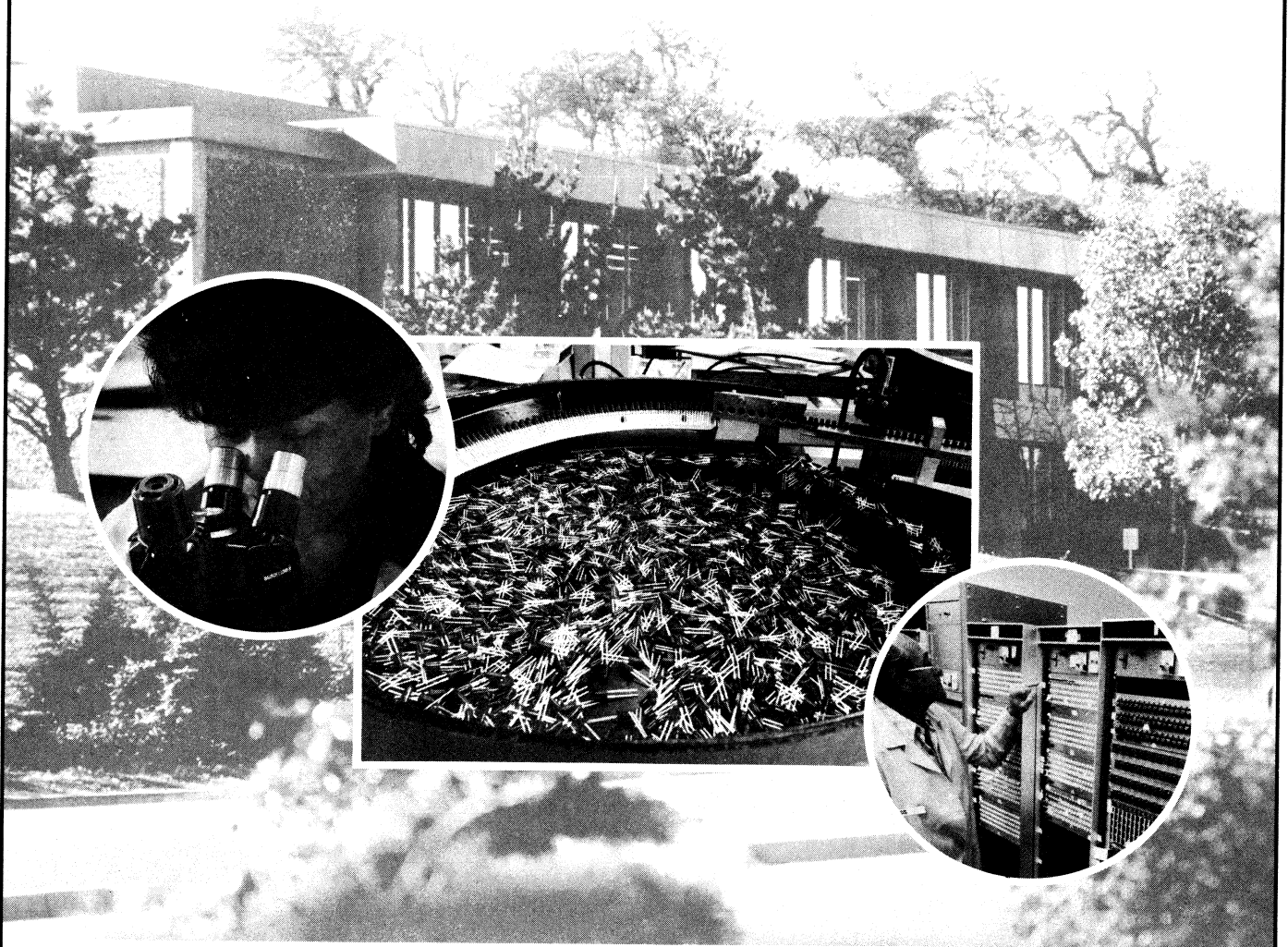
Customer Information

About This Catalog

This catalog of Monsanto light emitting diode products provides detailed information on the key devices in our extensive line. It illustrates the broadest line of LED products available anywhere from any one manufacturer . . .

- discrete lamps
- solid state displays
- optoisolators (optical couplers)

It also shows you how to find and obtain the product that best fills your design needs or to get additional assistance if required.



Monsanto

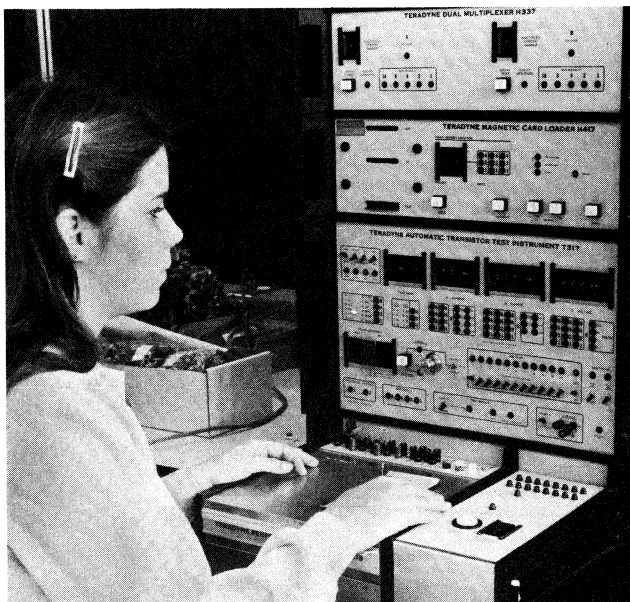
Cost/Value: the Key to Leadership

Monsanto has always applied high technological capability to product development and research activity. The results are shown in our experience in the areas of material development and available optoelectronic products.

QUALITY has always been a prime concern in any product development at Monsanto. Today, Monsanto light emitting diodes are considered to be of the highest quality available, primarily due to an extensive, well-planned quality assurance program and complementary engineering capabilities. High standards are set, and quality control checks throughout the assembly processes ensure products of quality.

This quality plus original design expertise, product assistance, customer order processing, shipment control and after-sale service demonstrates Monsanto's ability to satisfy customer requirements.

These characteristics combine to make Monsanto light emitting diodes the *best cost/value* available in the world.



High Performance Products

Monsanto's experience in processing, packaging, and materials technology has developed a broad line of high performance LED products:

- Numeric and alphanumeric displays
- Discrete LED Lamps
- Infrared emitters
- Optoisolators

Each of these product areas is stocked in depth with many variations of size, packaging, function, appearance, performance and color. In addition, constant research and development provide a steady influx of creative new products and continuous improvements in product performance.

Customer Service

Monsanto offers a complete sales network that is specifically organized to service the customer.

DISTRIBUTORS Stocking distributors are located throughout the world—

United States, Europe, Canada, Japan,
Australia, Africa—

to provide the customer with immediate availability of product quantities of most standard products.

SALES ENGINEERS/REPRESENTATIVES A large organization of highly qualified technical sales engineers is immediately available in all areas to offer assistance in design, concept, and product selection.

PRODUCT MARKETING An internal staff of product marketing personnel is available to provide further factory assistance. Organized by product area, they offer the customer broad experience and knowledge at the factory level.

APPLICATIONS ENGINEERING Providing complete backup for applications assistance or discussion of specific problems, Monsanto engineers ensure that the customer has all information sources available to him.

TABLE OF CONTENTS

	Page
CUSTOMER INFORMATION	ii
PRODUCT INDEX (Alpha-Numeric)	vi
TECHNICAL INFORMATION	
The Photometry of LED's (AN601)	3
Improper Testing Methods for LED Devices (AN603)	7
Discrete LED Selecting Made Easier (AN301)	11
Measuring LED Output (AN602)	19
Using LED's to Replace Incandescent Lamps (AN302)	23
MOS Logic Level Indicator (AN303)	25

PRODUCT INFORMATION

DISCRETE LED LAMPS

MV10B	Red LED	29
MV50	Red LED	31
MV52, MV53	Green and Yellow Light Emitting Diodes	33
MV54	Red LED	35
MV55A	Visible Red LED	37
MV5020 Series	Red Solid State Lamps	39
MV5054-1, MV5054-2, MV5054-3	Red Solid State Lamps	41
MV5050 thru MV5056	Red Solid State Lamps	43
MV5074B/C, MV5075B/C	Red Solid State Lamps	47
MV5077B/C	Red Solid State Lamps	49
MV5094	Red Bipolar Solid State Lamp	51
MV5152, MV5252, MV5352, MV5752	Solid State Lamps	53
MV5153, MV5154, MV5253, MV5254, MV5353, MV5354	Solid State Lamps	55
MV5174B/C, MV5274B/C, MV5374B/C, MV5774B/C	Solid State Lamps	57
MV5177B/C, MV5277B/C, MV5377B/C, MV5777B/C	Solid State Lamps	59
MV53124	Solid State Indicator	61
MV5491	Red/Green Tri-State Lamp	63
MV57124	Solid State Indicator	67
MV5753, MV5754	Solid State Lamps	69
MP21/22, MP51, 52	Panel Mounting Grommets	71

INFRARED EMITTERS, DETECTORS, SENSORS

MCA7	Reflective Object Sensor	75
MCA8, MCA81	Slotted Optical Limit Switch	79
MCT8, MCT81	Slotted Optical Limit Switch	83
MT1, MT2	Silicon Phototransistor	87
MT8020	Silicon Phototransistor	89

TABLE OF CONTENTS

	Page
INFRARED EMITTERS, DETECTORS, SENSORS (continued)	
ME60	Infrared Emitter 91
ME61	Infrared Emitter 93
ME7021, ME7024	Infrared Emitters 95
ME7121, ME7124	High Power Infrared Emitters 97
ME7161	Infrared Emitter 99
DISPLAYS	
MAN1, MAN1A	.27" Red Seven Segment Display 103
MAN10, MAN10A	.27" Alpha-Numeric Display 105
MAN1001, MAN1001A	.27" Red Polarity & Overflow Display 107
MAN101, MAN101A	.27" Red Polarity & Overflow Display 109
MAN2A	.32" Red Alpha-Numeric Display 111
MAN2815	8-Character, 14 Segment A/N Display 113
MAN50A, MAN3600A, MAN70A, MAN80A	Series 0.300" Green, Orange, Red and Yellow Segment Displays 115
MAN4600A Series	0.400" Orange Seven Segment Display 121
MAN6600 Series	0.560" Orange High Performance Display 125
MAN6700 Series	0.560" Red High Performance Display 129
OPTOISOLATORS	
4N25, 4N26, 4N27, 4N28 4N29, 4N30, 4N31, 4N32, 4N33	Phototransistor Optoisolators 135
4N35, 4N36, 4N37	Photo-Darlington Optoisolator 139
MCA230, MCA255	Phototransistor Optoisolators 143
MCA231	Photo-Darlington Optoisolator 147
MCL600, MCL610	Photo-Darlington Optoisolator 151
MCS2, MCS2400	Optically Isolated Logic Gate 153
MCS6200, MCS6201	Photo SCR Optoisolator 157
MCT2	Optically Isolated Solid State AC Dip Relay 161
MCT2E	Phototransistor Optoisolator 165
MCT210	Phototransistor Optoisolator 169
MCT26	Phototransistor Optoisolator 173
MCT271	Phototransistor Optoisolator 177
MCT272	Transistor, Selected CTR, UL Recognized 179
MCT273	Transistor, Selected CTR, UL Recognized 183
MCT274	Transistor, Selected CTR, UL Recognized 187
MCT275	Transistor, Selected CTR, UL Recognized 191
MCT276	Transistor, High Voltage Output, UL Recognized 195
MCT277	Transistor, High Speed, UL Recognized 199
MCT4	Transistor, Temperature Compensated TTL, UL Recognized 203
MCT4R	Phototransistor Optoisolator 207
MCT6	Phototransistor Optoisolator 209
MCT66	Dual Phototransistor Optoisolator 211
	Dual Phototransistor Optoisolator 213

ALPHA-NUMERIC PRODUCT LISTING

PRODUCT NO.	PAGE	PRODUCT NO.	PAGE	PRODUCT NO.	PAGE
4N25	135	MAN82A	115	MV5022	39
4N26	135	MAN83A	115	MV5023	39
4N27	135	MAN84A	115	MV5024	39
4N28	135	MCA230	147	MV5025	39
4N29	139	MCA231	151	MV5026	39
4N30	139	MCA255	147	MV5050	43
4N31	139	MCA7	75	MV5051	43
4N32	139	MCA8	79	MV5052	43
4N33	139	MCA81	79	MV5053	43
4N35	143	MCL600	153	MV5054-1	41
4N36	143	MCL610	153	MV5054-2	41
4N37	143	MCS2	157	MV5054-3	41
MAN1	103	MCS2400	157	MV5055	43
MAN1A	103	MCS6200	161	MV5056	43
MAN10	105	MCS6201	161	MV5074B	47
MAN10A	105	MCT2	165	MV5074C	47
MAN1001	107	MCT2E	169	MV5075B	47
MAN1001A	107	MCT210	173	MV5075C	47
MAN101	109	MCT26	177	MV5077B	49
MAN101A	109	MCT271	179	MV5077C	49
MAN2A	111	MCT272	183	MV5094	51
MAN2815	113	MCT273	187	MV5152	53
MAN3610A	115	MCT274	191	MV5153	55
MAN3620A	115	MCT275	195	MV5154	55
MAN3630A	115	MCT276	199	MV5174B/C	57
MAN3640A	115	MCT277	203	MV5177B/C	59
MAN4610A	121	MCT4	207	MV52	33
MAN4630A	121	MCT4R	209	MV5252	53
MAN4640A	121	MCT6	211	MV5253	55
MAN51A	115	MCT66	213	MV5254	55
MAN52A	115	MCT8	83	MV5274B/C	57
MAN53A	115	MCT81	83	MV5277B/C	59
MAN54A	115	ME60	91	MV53	33
MAN6610	125	ME61	93	MV53124	61
MAN6630	125	ME7021	95	MV5352	53
MAN6640	125	ME7024	95	MV5353	55
MAN6650	125	ME7121	97	MV5354	55
MAN6660	125	ME7124	97	MV5374	57
MAN6680	125	ME7161	99	MV5377B/C	59
MAN6710	129	MP21	71	MV54	35
MAN6730	129	MP22	71	MV5491	63
MAN6740	129	MP51	71	MV55A	37
MAN6750	129	MP52	71	MV57124	67
MAN6760	129	MT1	87	MV5752	53
MAN6780	129	MT2	87	MV5753	69
MAN71A	115	MT8020	89	MV5754	69
MAN72A	115	MV10B	29	MV5774	57
MAN73A	115	MV50	31	MV5777B/C	59
MAN74A	115	MV5020	39		
MAN81A	115	MV5021	39		

2

TECHNICAL INFORMATION

- The Photometry of LED's
- Improper Testing Methods for LED Devices
- Discrete LED Selecting Made Easier
- Measuring LED Output
- Using LED's to Replace Incandescent Lamps
- MOS Logic Level Indicator

AN601

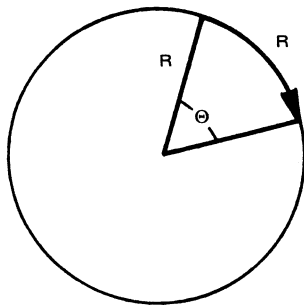
the photometry of LED's a primer in photometry

REVIEW OF GEOMETRIC PRINCIPLES

Any short discourse on the subject of photometry requires a brief review of geometric principles utilized.

RADIAN

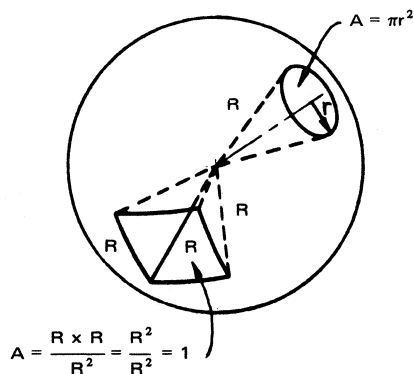
In plane geometry the angle whose arc is equal to the radius generating it is called a radian. Therefore, if $C = 2\pi R$ (Circumference of a circle) $2\pi R = 360^\circ$. Radian = $180^\circ/\pi = 57.27^\circ$ (approx.)



TWO DIMENSIONAL FIGURE
FIGURE 1

STERADIAN

In solid geometry one steradian is the solid angle subtended at the center of a sphere by a portion of the surface area equal to the square of the radius of the sphere. Therefore, if $AREA/R^2 = 1 = 1$ steradian and the area on the surface of a sphere equals $4\pi R^2$, then $4\pi R^2/R^2$ or 4π steradians of solid angle ω about the center of a sphere. The steradian is usually abbreviated as STER.



THREE DIMENSIONAL FIGURE
FIGURE 2

Other abbreviations of immediate concern are:

- Ae = Area of emitting (or reflecting) surface.
- Ap = Apparent area of an emitting source whose image is protected in space and viewed at some angle, Θ .
- Ad = Detection area. Whether a physical target or merely a defined spatial area, it is the area of interest.

PHOTOMETRIC TERMINOLOGY

FLUX (Symbol F)

Any radiation, whether visible or otherwise, can be expressed by a number of FLUX LINES about the source, the number being proportional to the intensity of that source. This LUMINOUS flux is expressed in LUMENS for visible radiation.

LUMINOUS EMITTANCE (Symbol L)

A source measurement parameter. It is defined as the ratio of the luminous flux emitted from a source to the area of that source, or $L = F/A_e$. Typically expressed in units of:

lumens/cm² or one PHOT,
lumens/m² or one LUX (or one METER CANDLE),
lumens/ft² or one FOOT CANDLE.

The foot candle is the more common term used in this country.

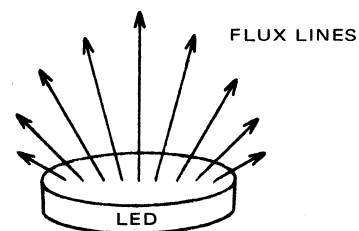


FIGURE 3

ILLUMINANCE (Symbol E)

This is a target or detector area measurement parameter. It is the ratio of flux lines incident on a surface to the area of that surface or $E = L/Ad$. Typical measurement units are the same for LUMINOUS EMITTANCE (above) i.e. lumen/cm² = one phot, lumen/m² = one lux, and lumen/ft² = one ft. candle.

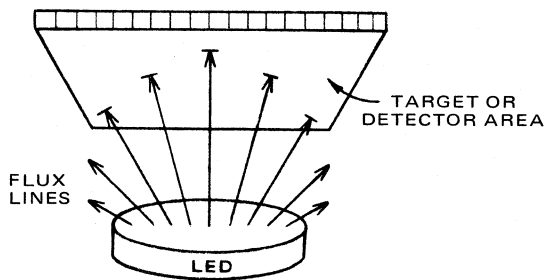


FIGURE 4

LUMINOUS INTENSITY (Symbol I)

A spatial flux density concept. It is the ratio of luminous flux of a source to the solid angle subtended by the detected area and that source. The LUMINOUS INTENSITY of a source assumes that source to be point rather than an area dimension. The LUMINOUS INTENSITY (or CANDLE POWER) of a source is measured in LUMENS/STERADIAN which is equal to one CANDELA (or loosely, one CANDLE).

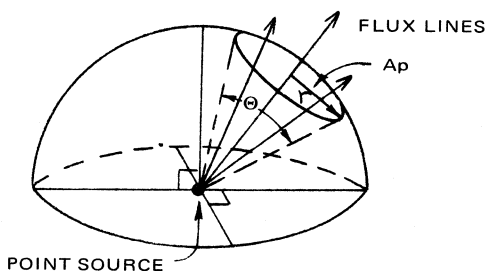


FIGURE 5

LUMINANCE (Symbol B)

Sometimes called photometric brightness (although the term brightness should not be used alone as it encompasses other physiological factors such as color, sparkle, texture, etc.) it is applied to sources of appreciable area size. Mathematically, if the area of an emitter (circular for example) has a diameter or diagonal dimension greater than

0.1 the distance to the detector, it can be considered as an area source. If less than this 10% figure, the source can be treated as point in nature. This one to ten ratio of source diameter to distance is offered as it MATHEMATICALLY very closely approximates results obtained when comparing an area source to its point equivalent. LUMINANCE presents itself as an extremely useful parameter as it applies a figure of merit to:

1. Apparent or projected area of the source (A_p).
2. Amount of luminous flux contained within the projected area of the source (A_p).
3. Solid angle the projected area generates with respect to the center of the source.

NOTE: The projected area A_p varies directly as the cosine of Θ i.e. max. at 0° or normal to the surface and minimum at 90°

$$A_p = A_e \cos \Theta$$

LUMINANCE is defined as the ratio of LUMINOUS INTENSITY to the projected area of the source A_p .

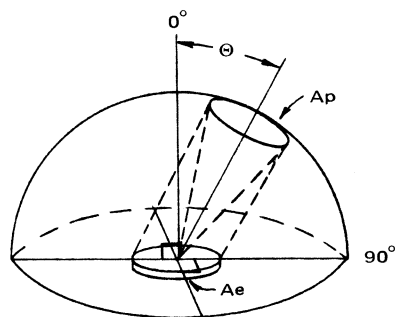


FIGURE 6

$$\frac{\text{LUMINOUS INTENSITY}}{A_p} = \frac{\frac{\text{LUMENS}}{\text{STERADIAN}}}{A_e \cos \Theta} = \frac{\text{CANDELAS}}{(\text{Sq. Unit})}$$

And depending on the units used for area:

- 1 CANDELA/cm² = 1 STILB
- 1 CANDELA/m² = 1 NIT
- 1 CANDELA/in² =)
- 1 CANDELA/ft² =) no designator available.

Also:

- $1/\pi$ candela/cm² = LAMBERT
- $1/\pi$ candela/m² = APOSTILB (or BLONDEL)
- $1/\pi$ candela/in² = no designator available
- $1/\pi$ candela/ft² = FOOT LAMBERT

LUMINOUS INTENSITY versus LUMINANCE

The successful application of either measurement parameter as a yardstick to duplicate mathematically the visual stimulation experienced by an observer is a controversy which will probably rage for some time. As the entire electromagnetic spectrum is bounded only by the capabilities of a detector to discern it, so for within the visual spectrum the eye is the limiting factor. SUBJECTIVELY speaking, the eye can discern finer increments of arc (computed from target to eye) than a 1 to 10 relationship, or approximately $5^{\circ} 43'$ min. In fact, it can be shown that for view angles of much less than 2 minutes, the eye translates the source into a point and thus the photometric measurement of LUMINOUS INTENSITY (in candelas) most directly correlates with subjective brightness. For view angles of much greater than approximately 2 minutes, the eye sees the source as an area source, and thus the photometric measurement of LUMINANCE most directly correlates with subjective brightness. A two minute view angle computes to a 1/1666 ratio of source diameter to distance ratio. For Monsanto's MV5025 this computes to approximately 22 feet ($1666 \times .16''$ diameter, approximately 22 feet) well within the expected normal viewing distance of an observer.

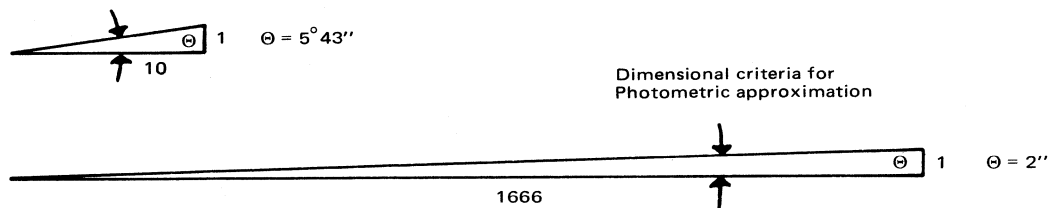


FIGURE 7

Considering that the usage of the discrete MV5025 LED is as an indicator and as such is utilized arms length or approximately 30'' away, it can be seen that the LUMINANCE parameter and its basic unit, the FOOT LAMBERT, most closely correlates with subjective brightness.

Below are the Monsanto products, their respective chip dimension, either diameter or diagonal, apparent size due to optical magnification and luminance/luminous intensity crossover distance. It should be stressed that this distance is not finite but represents a gradual threshold distance at which either parameter might be definitive.

Product	Active Chip Area	Optical Lens Factor	Apparent Size	Crossover Distance Feet
MV10B	.015''	x1.9	.028''	3.96
MV50	.017'' diag.	x1.75	.030''	3.0
MV5020	.017'' diag.	x1.5	.025''	2.5
MV5025	(.160'')*	(x15.2)	.160''	22.2

*Entire lens is considered the apparent emitting area.

RADIOMETRY

While photometric units are concerned with only the visible spectrum of wavelength, all frequencies of emission, including the visible are expressible in RADIOMETRIC terms. Radiometric terms and their photometric equivalents are as follows:

RADIOMETRIC

Radiant flux (Symbol P) expressed in watts
Irradiance (Symbol H) expressed in watts/sq. unit
Radiant Emittance (Symbol W) expressed in watts/sq. unit
Radiant Intensity (Symbol J) expressed in watts/steradian
Radiance (Symbol N) expressed in watts/ster/sq. unit

PHOTOMETRIC

Luminous flux (F) expressed in lumens
Illuminance (E) expressed in lumens/sq. unit
Luminous Emittance (L) expressed in lumens/sq. unit
Luminous Intensity (Symbol I) expressed in lumens/steradian
Luminance (B) expressed in lumens/ster/sq. unit

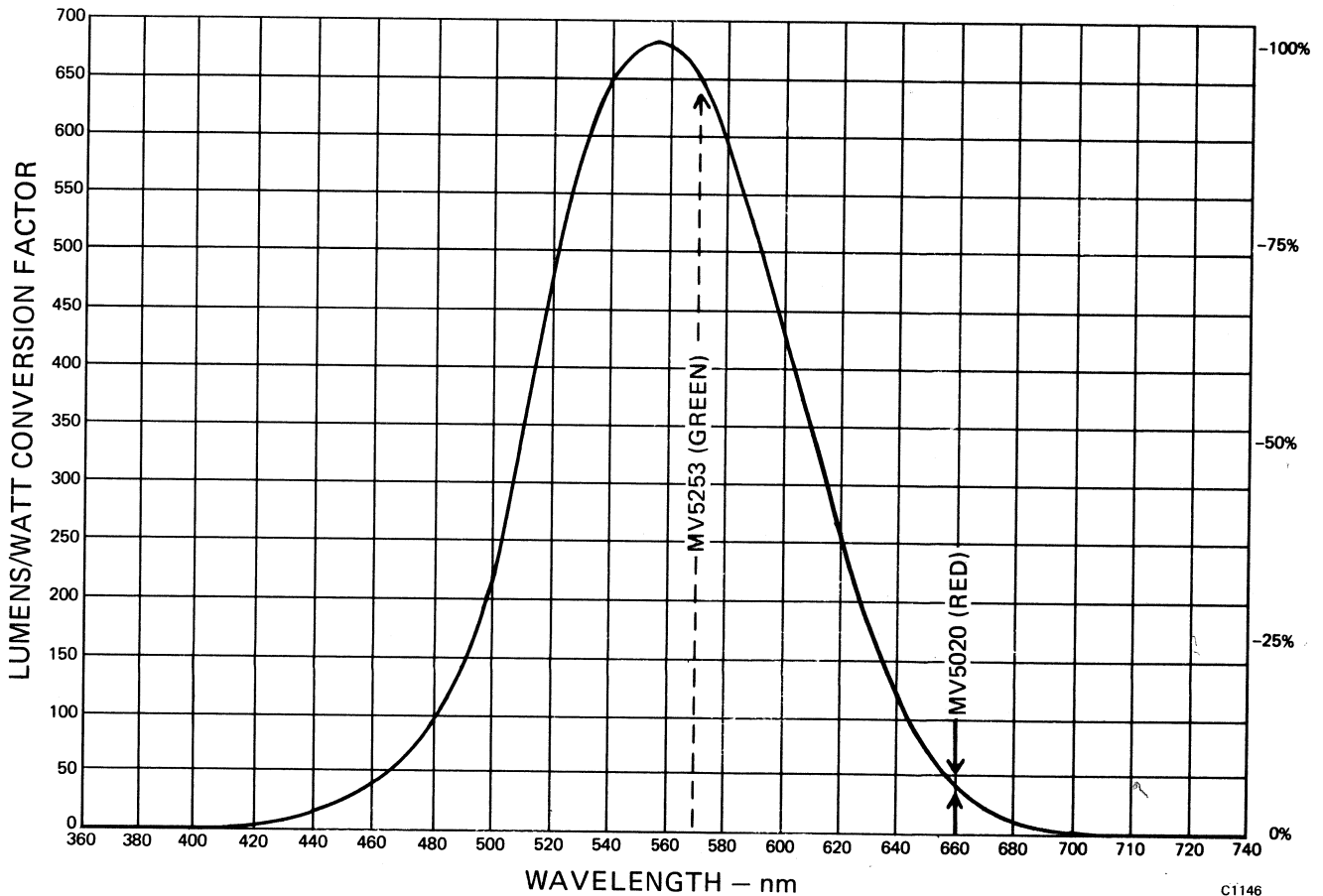
CIE CURVE

Following is the standard observer curve or "standard eyeball" established by the Commission Internationale de l'Eclair (commonly called the CIE curve). Whereas one watt of radiated energy at any frequency corresponds to one watt of radiated energy at any other frequency, this relationship fails to hold true for photometric measurement. The CIE curve is essential therefore, not only in determining the eye's efficiency at any particular wavelength, but also the corresponding lumens per watt conversion of that particular wavelength.

For example, the MV5020 which emits $180 \mu\text{W}$ of radiant energy at 6600\AA (typical) or 41.4 lumens per watt has

$$180 \times 10^{-6} \text{ watts} \times \frac{41.4 \text{ lumens}}{\text{watt}} = 7.45 \text{ mLumens}$$

of flux emitted from it.



Similarly, a green emitter such as the MV5253 operating at an identical input power as the red will emit $10 \mu\text{watts}$ of radiant energy or

$$10 \times 10^{-6} \text{ watts} \times \frac{649 \text{ lumens}}{\text{watt}} = 6.49 \text{ mLumens}$$

of flux emitted from it. In short although there exists at least an order of magnitude difference in radiant power the eyes' compensating effect "magnifies" the green to appear equally bright.

AN603

improper testing methods for LED devices

In any manufacturing operation it is essential that the materials used in the fabrication process meet the minimum quality specifications of the device under production. To that end, prudent manufacturers establish some sort of incoming quality assurance system to make sure that defective materials are culled at the door. It is equally important, however, that the screening system used in the Q.A. inspection does not reject materials which are acceptable, and that the testing procedures utilized in the system do not inadvertently damage materials which are otherwise acceptable. Unfortunately, this latter aspect of quality assurance procedures is often neglected, and whenever a device is rejected because of inappropriate testing methods, both the manufacturer and the vendor are subject to a great deal of unnecessary expense and inconvenience. Because many manufacturers who buy LED components are relatively inexperienced with the features and limitations of III-V devices, problems involving improper testing methods and unnecessary materials rejection are of particular concern to LED vendors. This note is intended to familiarize the user with the basic electrical and opto-electrical properties of LED devices and to clear up some of the problems involved in testing them.

THE MATERIAL

Historically, silicon and germanium were the first semiconductor materials to have been used for p-n junction devices such as transistors, diodes, and solar cells. However, following closely upon the invention of the germanium transistor in 1948, work was begun on predicting the semiconductivity of a material from its chemical compound. Based on energy band-gap experimentation, it was discovered that III-V materials have semiconductor properties.¹

Gallium semiconducting materials, Gallium Arsenide (GaAs), Gallium Arsenide Phosphide (GaAsP), and Gallium Phosphide (GaP) are the materials from which LED's are fabricated. These materials have the ability to emit a narrow band of monochromatic light in either the visible or infrared spectrum, depending on the constituent and ratio of ingredients. The mechanism for this emission of radiant energy is best described in terms of

semiconductor Energy-Band Theory. When an external, forward-biasing voltage is applied to a p-n junction, the conduction mechanism is such that electrons are excited by the electric field, gaining enough energy to cross the energy gap from the valence band to the conduction band, and then to relax back from the conduction band into the valence band. During the transition from the valence band to the conduction band, the electrons take energy from the field. As they pass back into the valence band, the electrons release this energy in the form of light photons. The amount of energy released is determined by the width of the energy gap. (The wavelength, or color, or the light is a function of the energy gap.) The light is emitted directly from the electrons within the depletion region formed between the two sides of the junction.

The electrical characteristics of LED's are also related to the energy gap. For example, the conduction threshold, or "knee" point on the I_f/V_f curve in the forward-biased direction occurs at approximately 1.0 volts for infrared LED's, at approximately 1.3 volts for visible red LED's, and from 1.8 to 2 volts for yellow and green LED's. The brightness of the light is directly proportional to the operating current flowing in the forward direction.

GALLIUM VS. SILICON

As a semiconductor, III-V compounds using Gallium have several advantages over silicon and germanium—reverse leakage current is several orders of magnitude lower; forward current is lower below the "knee" point; inherent thermal noise is lower; and carrier mobility is high. Perhaps the greatest advantage, certainly where LED's are concerned, is the ability to produce light directly from electron flow.

Figure 1 shows a comparison between the forward conduction characteristics of diodes formed from III-V materials and silicon. Notice that the "knee" of the conduction curve for the Gallium diodes occurs at higher voltages, and is harder than the "knee" of silicon diodes. Notice also that as the wavelength progresses from the infrared toward the blue end of the spectrum, the GaAsP "knee" points get progressively higher and the slope of the I_f/V_f curve tends to decrease. Excluding exotic devices such as Schottky or Esaki diodes, silicon diode de-

¹E.G. Bylander, *Materials for Semiconductor Functions* (New York, 1971), p. 17.

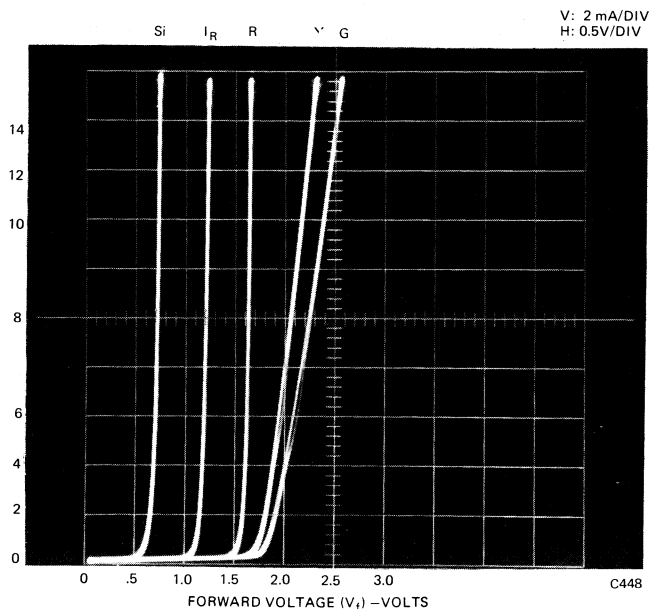


Fig. 1. Typical I_f/V_f Curves of Silicon, GaAs, and GaAsP, GaP (Silicon-1N914, IR-ME7024, Red-MV5053, Yellow-MV5353, Green-MV5253)

vices normally show little difference in the forward conduction curve.

The reverse characteristics of III-V materials are similar to those of silicon except that silicon's thermal leakage current is higher at very low reverse voltages. The reverse breakdown voltages of silicon are typically higher, and the characteristics of silicon devices are usually controlled for reverse breakdown at particular voltages. The reverse breakdown characteristics of diodes used in LED devices are not particularly controlled, since the quality of light emission is the first priority. The Monsanto MANX and MANXX series displays use LED's which have a typical reverse-mode breakdown voltage range of from 5 to 20 volts. However for guard-band purposes, the reverse voltage is specified on the data sheets at 5 volts minimum.

If a silicon device is subject to junction damage, it will often continue to perform adequately because of silicon's inherent annealing capability. When damage occurs to the junction of an LED device, however, the result is usually a softening of the "knee" or a flattening of the I_f/V_f curve. Although the device may continue to operate, performance will be less than satisfactory, and early failure may result.

DAMAGE MECHANISMS

The discussion which follows will treat, in some detail, the most common errors in LED test set-ups and will

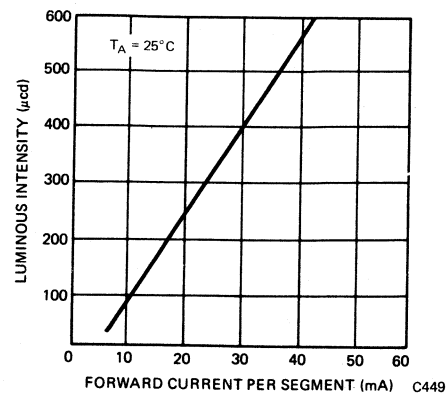


Fig. 2. Typical LED Curve Luminous Intensity vs. Forward Current for Constant Temperature

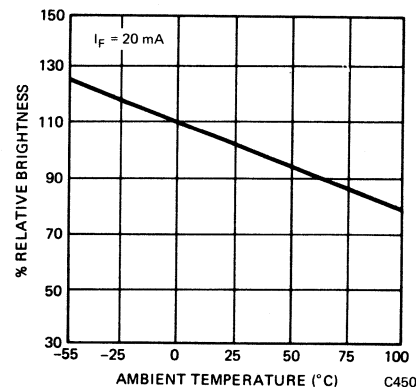


Fig. 3. Typical LED Curve Brightness vs. Temperature for Constant Current

suggest either alternative testing methods or means by which improper testing methods can be corrected to produce more reliably accurate results.

Testing for Fabrication Defects

Thermal Shock—is a passive mode test involving a rapid refrigerate/heat cycle in which no current is applied to the device. This test is a good method for detecting weak bonds and, therefore, locating defective devices, but it should be used cautiously, especially with LED's. In LED's a 1-mil gold wire is bonded from the top of the die over to the side contact, whether it is lead frame or substrate. The wire is surrounded by the epoxy which encloses the die and forms the package. When heat is applied, the epoxy, the gold, and the lead frame all expand at different rates. Thus, when the device is heated up too rapidly, the effects on the bond are similar to giving the wire a hard jerk. This action constitutes thermal shock and tends to weaken even good bonding and, consequently, shorten life expectancy.

Burn-In—consists of operating the device at elevated temperatures, thus accelerating the effects of operationally imposed heating. This method is frequently used in testing semiconductors, but its use is not advised with LED's, especially if the testing involves operating with excess current or current which exceeds the device ratings for several hours. LED's exhibit a gradual degradation of brightness as a function of current, time, and

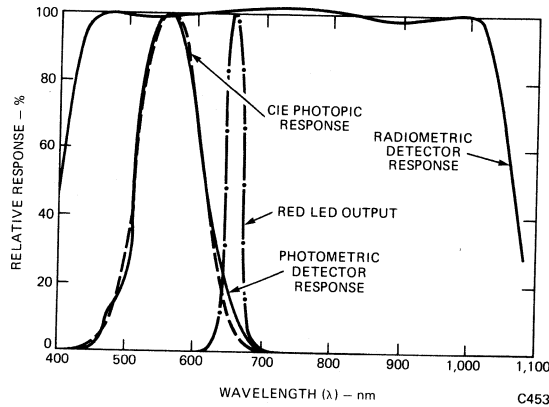


Fig. 6. Responses of Two Detectors to the Output of a Visible Red LED

Brightness Tests

Optical measurements are typically, and in most instances, unavoidably, of very low accuracy. Optical measurements with errors of less than 1% are rare, and accuracy within 5% is difficult to obtain. With an experienced technician using good equipment it is possible to secure accuracy within 10% to 20% on a routine basis, but even here a slight difference in technique can result in errors in excess of 50%.

Detectors—A good detector approximates the CIE curve area with 2%. However, it is important to note that even when the detector is within 2% of perfect, it is still possible to produce mismatches at specific wavelengths which can cause the percentage of error to increase considerably. Therefore, in order to determine the margin of possible error, it is imperative that one know the detector's spectral response within the wavelength range of the device to be measured. To illustrate the problem of spectral mismatch, the reader is referred to Figure 6 where we show the responses of two detectors, a radiometric detector and a photometric detector, to the output of a visible red LED. The response of the radiometric detector is about 3% high. Notice, however, that the photometric detector, which provides a very close match to the CIE curve, produces a +25% error.²

Additional factors which must be considered are detector aging and filter deterioration, nonlinear detector responses, circuitry which is not temperature-compensated, and stray light. Periodic calibration is essential if a reasonable degree of accuracy is to be maintained. For a detailed discussion of various LED measurement techniques and procedures, and of various methods for avoiding potential problem areas, refer to Monsanto Application Note, AN602.

Correlation Samples—Unless the testing apparatus is reciprocally related to a vendor-supplied correlation sample, test results may erroneously indicate that many devices in a shipment do not meet the minimum brightness that was specified on the order, and could result in

the rejection of devices which do meet minimum standards. Correlation samples are also essential for the correction of instrumentation drift.

Subjectivity Problems—In some instances a visual comparison may be the best method for brightness testing. However, the manner by which the human eye "sees" is affected by various factors such as the nature of the light source, viewing distance, color, texture, the observer's visual acuity, and even the viewer's emotional state. Therefore, because of these highly subjective factors involved in human visual perception, such tests alone are usually inadequate and should be used only as a supplement to or in correlation with instrumentation. It has been our experience that manufacturers who rely solely on visual testing return many devices, a fair percentage of which can be reshipped and accepted.

Testing to Parameters Other Than Those Specified—This is a particularly important consideration when a manufacturer specifies his own parameters distinct from those normally specified. To avoid unnecessary rejection of devices, it is imperative that a device is **always tested to the parameters under which it will be expected to operate.**

SUGGESTIONS FOR PROPER TESTING

That which follows is a quick check list of "do's" which enable manufacturers to avoid many of the problems associated with running incoming quality assurance tests on LED's.

- In cooperation with the vendor, establish specifications which are economically feasible and ensure that devices are screened at their point of origin.
- Always obtain a correlation sample from the vendor before setting up the test procedure.
- Establish a reliable test procedure.
- Measure relevant parameters at relevant points.
- Make sure that the test circuitry will not erroneously indicate defects and that it will not generate failures later in the manufacturing cycle.
- Work closely with the vendor in establishing the test system.

²Michael A. Zaha, "Shedding Some Needed Light on Optical Measurements," *Electronics*, November 6, 1972, pp. 94-96.

AN301

discrete LED selecting made easier

Light Emitting Diodes, LED's, have come into widespread use on the electronics scene. This Application Note is intended to aid the designer in selecting a particular device from the many LED's offered today. The more important parameters as well as some little-known pitfalls are discussed.

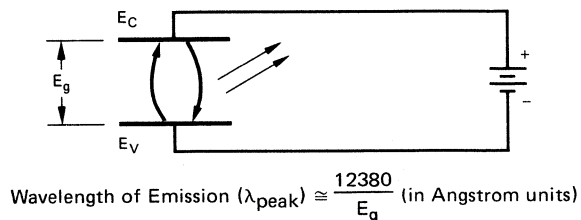
THEORY

Although light emission from a semiconductor junction had long been speculated, the first commercial devices did not become available until about 1963. This light emission phenomenon can be explained in terms of Semiconductor Energy-Band Theory. An external voltage applied to forward-bias a PN junction excites the majority carriers (electrons), causing them to move from the N-side Conduction Band to the P-side Valence Band. In making this transition the electrons cross the Energy Gap, E_g , that separates the two Bands, and so have to give up energy in the form of heat (phonons) and light (photons).

Each semiconductor material type has an E_g characteristic, and the wavelength (λ) of emitted light depends upon the magnitude of E_g , (see Figure 1). For example, Gallium Arsenide material, GaAs, has an $E_g = 1.35$ eV and a $\lambda_{peak} = 9000 \text{ \AA}$. The wavelength (i.e., color) emitted by some other materials made from Gallium compounds are listed in Table 1.

Material	Wavelength	Color
GaAs:Zn	9000Å	infrared
GaAsP _{.4}	6600Å	red
GaAsP _{.5}	6100Å	amber
GaAsP _{.85} :N	5900Å	yellow
GaP:N	5600Å	green

Table 1. Some Wavelengths and Colors Emitted by Gallium Compounds



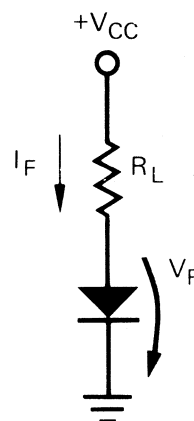
[Equation 1]

Fig. 1. Relationship Between Band-Gap Energy and Wavelength

ELECTRICAL CONSIDERATIONS

Most incandescents are rated in terms of voltage; LED's, on the other hand, are current-dependent devices since they are basically diodes. When operating from constant-voltage sources, protection should be provided by incorporating a current-limiting resistor with each LED.

Basic DC Circuit. For the simple circuit shown in Figure 2 the resistor value can be calculated from



$$R_L = \frac{V_{CC} - V_F}{I_F}$$

[Equation 2]

C1147

Figure 2.

where V_F and I_F are taken from an LED Data Sheet. The power rating required for the resistor should also be kept in mind.

Design Example #1: Suppose that a Monsanto MV50 is to be used with Figure 2's circuit and a V_{CC} of +5 volts. Figure 3a shows the MV50's Brightness versus I_F curve, and Figure 3b shows I_F vs. V_F . (Note that Brightness varies directly with I_F). Further suppose that a Brightness of 800 foot-Lamberts is decided upon. From Figure 3a we see that I_F must be set at 13 mA, from Figure 3b we see that V_F will be 1.5 volts when I_F is 13 mA. Substituting these values in Equation 2, we obtain

$$R_L = \frac{V_{CC} - V_F}{I_F}, R_L = \frac{5 - 1.5}{0.013}, R_L = 269 \text{ ohm.}$$

From the expression, $Power = (I_F)^2 R_L$, we see that R_L 's power rating can be 1/8 watt.

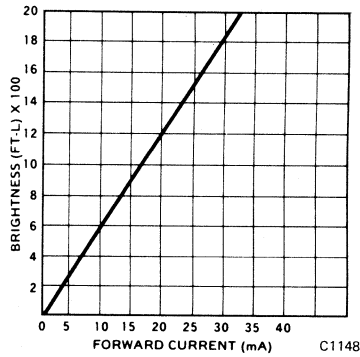


Figure 3a.

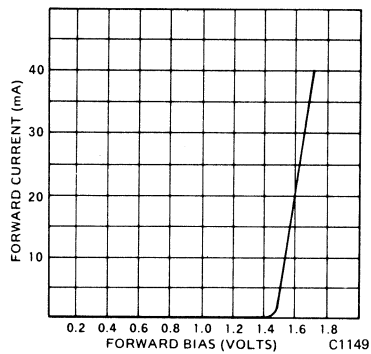


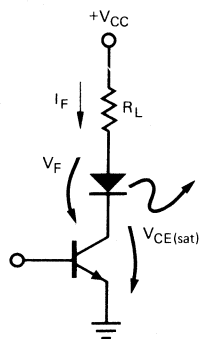
Figure 3b.

Active-Low Drive Circuit. Figure 4 shows a single-transistor drive circuit that lights the LED when the transistor is "low," i.e., conducting. The value for R_L can be calculated from

$$R_L = \frac{V_{CC} - V_F + V_{CE(sat)}}{I_F}$$

[Equation 3]

Active-High Drive Circuit. Figure 5 shows a single-transistor drive circuit that lights the LED when the transistor is "high," i.e., not conducting. Equation 2 can be used for calculating the value of R_L . The transistor should have a V_{CE} of approximately 0.4 volts when conducting.



C1150

Figure 4.

Figure 6 shows a circuit that has an MOS IC output driving both an LED and a TTL logic input.

Design Example #2: Suppose that a given MOS ROM, operated with $V_{SS} = +12$ volts, $V_{GG} = -12$ volts, and $V_{DD} =$ ground, is to drive an LED and a TTL logic input. Further suppose that the LED's Brightness is to be adequate for use as a trouble-shooting indicator lamp.

From the Data Sheet for a Monsanto MV55 we see that this low-cost, low-current LED typically delivers a usable 125 foot-Lamberts when I_F is 1 mA, and has an I_F maximum rating of 3 mA. A value of 6.8 Kohm should be used for R_L .

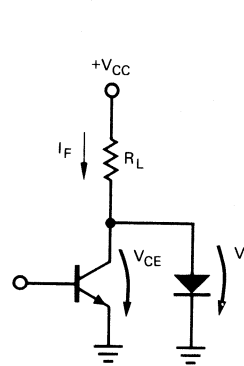
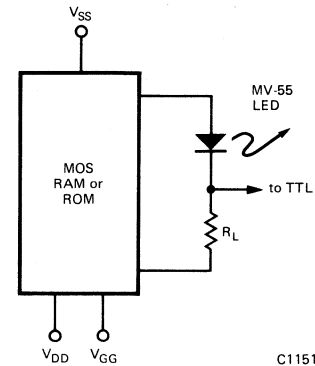


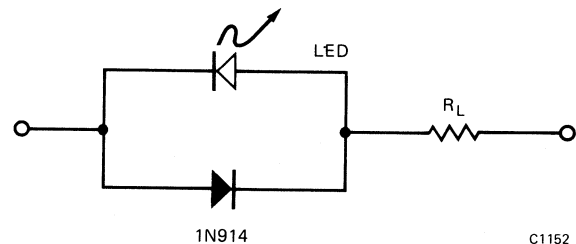
Figure 5.



C1151

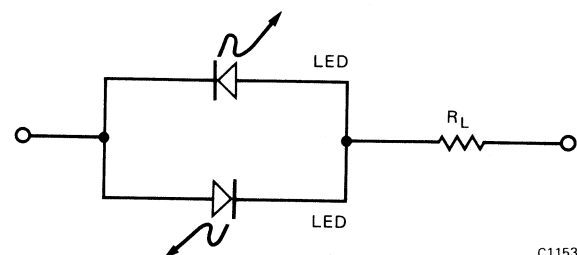
Figure 6.

AC Operation. LED's should be operated in the forward direction only. Therefore, the LED circuit must provide reverse-voltage protection if applied voltage is expected to exceed the V_R maximum rating of the LED. Figure 7a shows a circuit having an ordinary silicon diode (e.g., 1N914) placed "back-to-back" with the LED. Figure 7b shows an alternate and more novel approach that utilizes two LED's in parallel. If no current flows, neither LED lights. But as long as current does flow (in either direction), one of the LED's lights and one does not (because one LED will be conducting



C1152

Fig. 7a. Bipolar Operation



C1153

Fig. 7b. Bipolar Operation

and the other not conducting.) An extension of this back-to-back thinking led to the development of the bipolar devices, i.e., the MV5094 (Red/Red) and the MV5491 (Red/Green). These are actually two diodes in each package allowing either AC/DC or tri-state status indication.

If reverse operation (below breakdown) is expected for any length of time, then the designer should be aware of the fact that reverse leakage over temperature of LED materials (GaAs, GaAsP, etc.) is significantly less than that of silicon diode materials.

Pulsed Operation. Significantly higher peak LED light output can be obtained from ampere-level drive current pulses (of narrow width and at low duty cycle) than from steady-state driving. For example, total radiated power (expressed in milliwatts) from a Monsanto ME7021, infrared-emitting LED, operated steady-state (typically with $I_F = 100$ mA) is 2 mW. But this output increases to 50 mW when driven by a 6 amp, one microsecond-wide pulse at 0.1% Duty Cycle. It should be pointed out that this factor of 25 increase comes at the expense of a somewhat lower internal (quantum) efficiency.

Besides the increase in average power just described, pulsed operation of visible-emitting LED's also gives rise to a human perception phenomenon commonly known as Light Enhancement. This phenomenon is due in part to the eye's retention of high brightness levels (such as those produced by camera flash bulbs). A numerical Light Enhancement Factor (always greater than 1) can be defined by the following ratio:

Light Enhancement Factor =

$$\frac{I_{DC} \text{ (steady-state operation) to produce Brightness "B"}}{I_{\text{average}} \text{ (pulsed operation) to produce Brightness "B"}}$$

[Equation 6]

This Light Enhancement phenomenon is available only from GaAsP because this LED material will not saturate under high-current conditions.

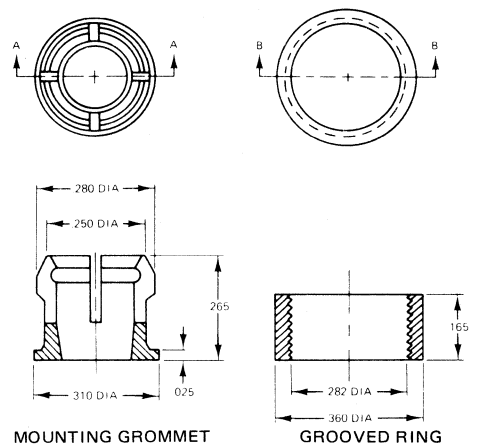
When the human eye is the detector of visible energy, lower average power is consumed by pulsed operation than by steady-state operation. This advantage of pulsed operation is especially important for battery-powered applications and for applications in which large LED arrays are being driven.

MOUNTING CONSIDERATIONS

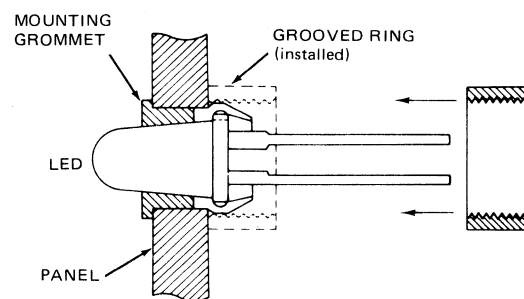
Panel Mounting. In the "Pop-In" panel mounting method, (see Figure 8a), a black plastic mounting grommet is placed over the top of the lens and the LED is inserted—leads first—into the panel mounting hole until the grommet's flange butts against the panel. Next a grooved ring is placed against the inside-panel end of the grommet, and the ring is pushed on until the LED is securely held in place. The grommet's black color provides contrast improvement. This mounting method allows mounting of the Monsanto MV5020-Series (T1 $\frac{3}{4}$ size) lamps in $\frac{1}{4}$ in. diameter holes on panels having thicknesses from 0.62 in. to 0.125 in.

A method for mounting LED types without using mounting hardware is to drill the panel holes and either epoxy the LED's into place or solder them to a back-panel printed circuit board, (see Figure 8b).

Printed Circuit Board Mounting. The most common techniques for mounting LED's on P.C. Boards are illustrated in Figure 9. The lead bending can be per-



C1154



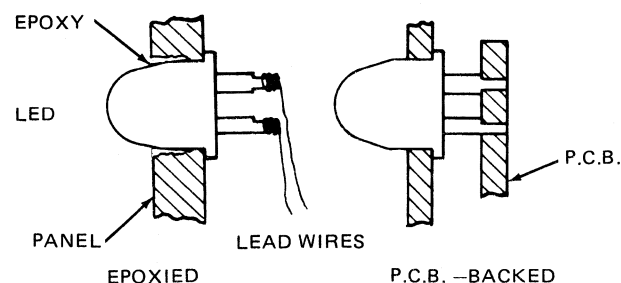
C1555

Figure 8a.

formed by the user, or arrangements can be made to have it done prior to shipment from the Factory.

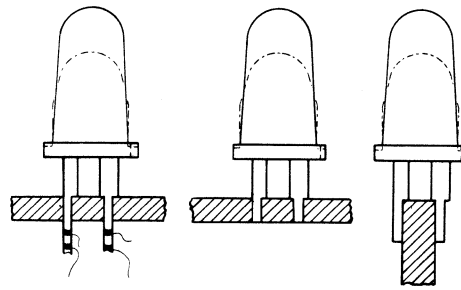
OPTICAL CONSIDERATIONS

Lens Effects. Lenses of the earliest LED's were designed to pass maximum light in the forward direction, i.e., perpendicular to the mounting surface, (see Figure 10). Later LED's produced more light and their lenses were designed to spread light over a wider area, thus permitting broader observer viewing angles. Still later, as higher light output LED's became available, a variety of red-colored, epoxy lenses came into use. These lenses act to diffuse light into a broader apparent emitting area. LED lenses that produce a broad, evenly-diffused light

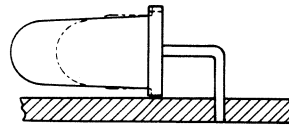


C1156

Fig. 8b. LED's Mounted Without Hardware



(a) LED's mounted without leads being bent



(b) LED mounted with leads bent

C1157

Fig. 9. Techniques for Mounting LED's on P.C. Boards

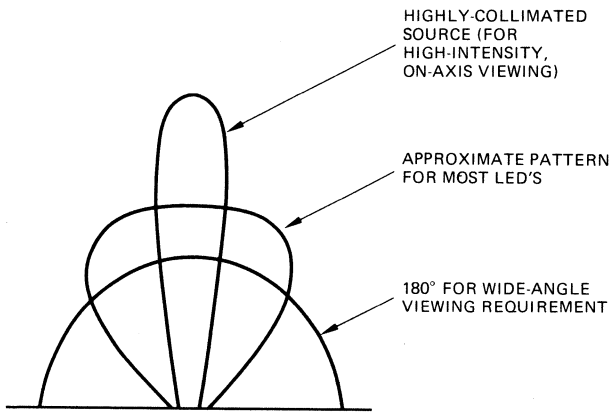


Fig. 10. Different Lens Effects (Used on the Same LED)

Light Measurement. The manner by which the human eye "sees" is highly subjective and is affected by various factors such as "nature" of the light source (i.e., "point" or "area" source), viewing distance, color, and the observer's visual acuity. For example, it has been found that a "standard" observer with 20/20 vision can discern objects having dimensions that transcribe angles as small as two minutes. To such an observer a source having a 0.16-inch diameter and positioned farther away than 22 feet seems more "point" than "area" in nature.

Two photometric parameters which designers find useful for evaluating LED light output are Luminous Intensity, I, and Luminance (Brightness), B, (see Table 2). While an infinitely-small light source exists in theory only, the following expression can provide a means for determining the distance at which the eye loses its ability to discern an "area" and begins to see a "point."

are generally assumed to be more pleasing to the eye than lenses that produce a highly-intense point of light. Figure 11 illustrates the effects of adding varying amounts of red diffusants to the epoxy lens material.

$$\text{THRESHOLD DISTANCE} = \frac{\text{Diameter of Light Source}}{\text{TAN } 0^{\circ} 2'}$$

(At which sources "lose" their area) [Equation 7]

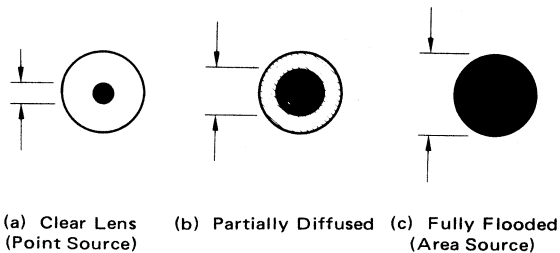


Fig. 11. Epoxy Lenses With Varying Amounts of Diffusants

From this determination the designer can decide whether to use the I or B parameter for his evaluation of LED light output. The "diameter of the light source" in Equation 7 is the apparent emitting area of the LED. For a "clear" lens LED, (Figure 11a), multiply diode emitting area by the lens magnifying factor. (Unless stated otherwise, most clear lenses magnify by about 2X.) For a "flooded" lens LED, (Figure 11c), use the outside package diameter. For a partially-diffused lens LED, (Figure 11b), a good rule of thumb is one-half the outside package diameter.

Nature of Source	Photometric Parameter	Symbol	Units	Measurement of
Point	Luminous Intensity	I	candela	Luminous Flux/steradian
Area	Luminance (Brightness)	B	foot-Lambert	$\frac{\text{Luminous Flux/steradian}}{(\pi)(\text{Area of source in ft}^2)}$
			stilb	$\frac{\text{Luminous Flux/steradian}}{\text{Area of source in cm}^2}$

Table 2. I and B Photometric Parameters

Contrast Ratio. The degree by which an observer distinguishes an object or source is a function both of time spent looking and of Contrast Ratio. Contrast Ratio is defined as "the difference in Luminance between an object and its background," or

$$\text{CONTRAST RATIO} = \frac{L_s - L_b}{L_b}$$

where "L_s" is a Source Luminance and "L_b" is Background Luminance

[Equation 8]

After an observer has focused on an object for longer than about one second, the time factor becomes negligible and Contrast Ratio remains as the important factor.

Human Factors Studies have shown that a Contrast Ratio of 10 is the minimum design value. Knowing this, and knowing the background Luminance of some

common materials under normal illumination levels, we can easily determine the minimum acceptable Luminance levels required from our LED light sources.

Design Example #3: Suppose that the illumination level produced by normal laboratory lighting is approximately 25 foot-candles, and that the reflection from a light-gray panel under this lighting produces a Background Luminance, L_b, of approximately 10 foot-Lamberts. What is the minimum acceptable Luminance which must be produced by an LED mounted on this panel?

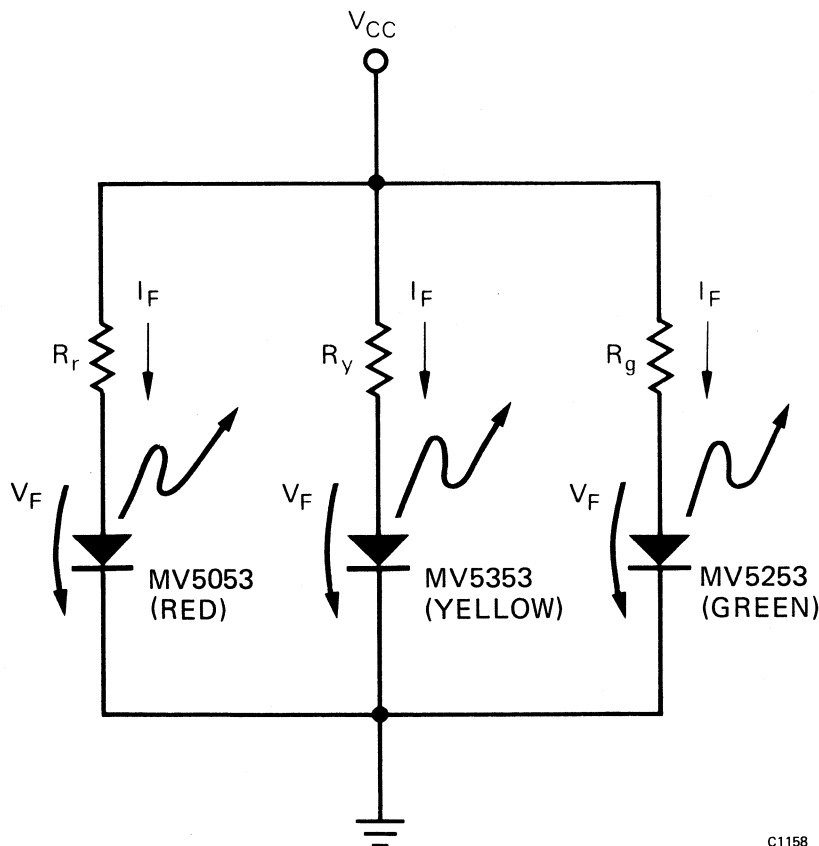
Substituting the above values into Equation 8, we have

$$10 = \frac{L_s - 10}{10}, \text{ or } L_s = 110.$$

Therefore, for an LED installed on a light-gray panel and used in this lighting environment, we see that the minimum acceptable level of Luminance is 110 foot-Lamberts.

Colors. LED's are now available in various colors. In some applications the designer may be called upon to develop circuits in which LED's of different colors are to produce equal Brightness. Since light output from an LED is basically a function of current flow through the PN junction, equal Brightness can be achieved by adjustments of current flow.

Design Example #4: Suppose that three LED's, one each of red, yellow, and green, are to each produce a luminous intensity of 2 mcd when installed in the circuit shown in Figure 12. Further suppose that V_{CC} is set at +5 volts and the LED types chosen are Monsanto's MV5053 (red), MV5353 (yellow), and MV5253 (green).



C1158

Fig. 12. Brightness Matching Different Colors

First the values of I_F needed to produce 2 mcd in each LED must be determined. From the data sheets we are given that the MV5053 typically produces 1.6 mcd when I_F is 20 mA; the MV5253 produces 1.5 mcd when I_F is 20 mA; and MV5353 produces 6.0 mcd when I_F is 20 mA. The brightness- I_F relationship for LED's can be assumed to be linear for I_F values within the maximum ratings. Therefore, knowing these points and that the luminous intensity is zero when I_F is zero, we can plot the straight-line relationship for each LED type (see Figure 13). From these plots we see that the MV5053 produces 2.0 mcd when I_F is 25 mA; the MV5253 when I_F is 26 mA; and the MV5353 when I_F is 7 mA.

Now the resistor values for R_r , R_y , and R_g can be calculated using Equation 2.

$$R_L = \frac{V_{CC} - V_F}{I_F}$$

with V_F taken as the "typical" values given on the data sheets. We then have:

$$R_r = \frac{5 - 1.65}{.025} \quad R_y = \frac{5 - 2.1}{.007} \quad R_g = \frac{5 - 2.2}{.026}$$

$$R_r = 134 \text{ ohms} \quad R_y = 414 \text{ ohms} \quad R_g = 108 \text{ ohms}$$

It should be noted that the foregoing analysis holds true only as long as spatial distribution (beam pattern) and apparent image size are very nearly the same for all LED's, regardless of color.

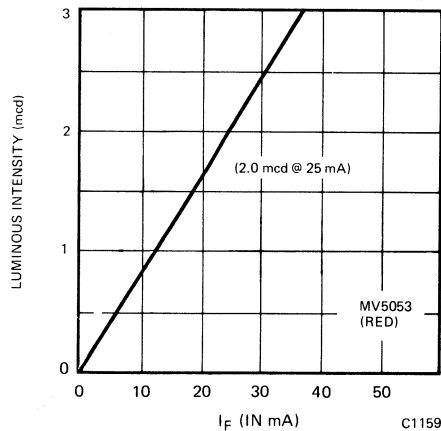
Infrared LED Sources. Visible-emitting LED's, the vital link in the man-machine interface, are characterized in terms of Photometric quantities. On the other hand, infrared-emitting LED's (whose invisible light is of wavelengths longer than 750 nanometers) are characterized in terms of Radiometric quantities. Also, applications requirements for infrared LED sources are different from those for visible-emitting LED's. Whereas for visible-emitting LED's a wide viewing angle is normally important, for infrared sources a narrow beam width and high on-axis intensity are normally important. Light output produced by infrared sources is defined by one or more of the following Radiometric parameters (see Table 3):

Radiated Output Power (P) or (ROP)—Total output of the device in all directions (measured in Watts).

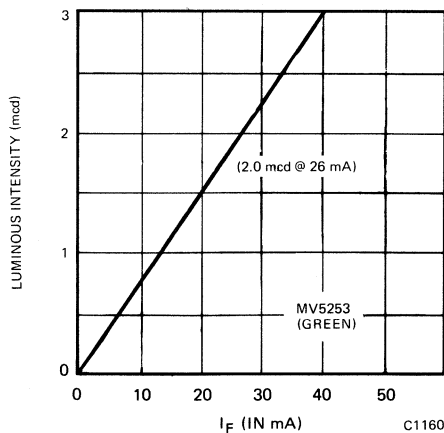
Radiant Intensity (J)—Radiant flux per unit solid angle in a given direction (measured in Watts/steradian).

Irradiance (H)—The density of radiant flux incident on a surface (measured in Watts/area).

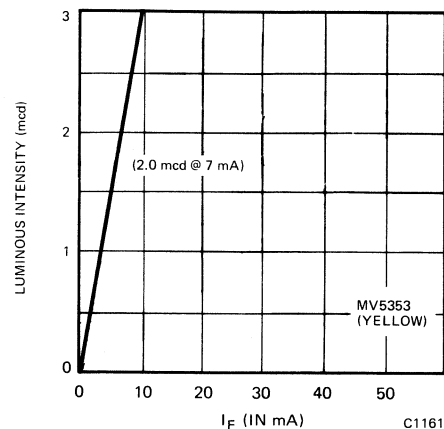
Irradiance is a particularly useful parameter because it describes how much output power is available at a given



(a)



(b)



(c)

Figure 13.

Table 3.

	Parameter and Symbol		Definition	Units	Abbrev.
RADIOMETRIC	Radiant Energy	Q_e		erg joule calorie kilowatt-hour	J cal kWh
	Radiant Flux	P	$P = \frac{dQ_e}{dt}$	erg per second watt	erg s ⁻¹ W
	Radiant Emittance (see Note 2)	W	$W = \frac{dP}{dA}$	watt per sq. cm, watt per sq. m, etc.	W cm ⁻² W m ⁻²
	Irradiance	H	$H = \frac{dP}{dA}$	watt per sq. cm, watt per sq. m, etc.	W cm ⁻² W m ⁻²
	Radiant Intensity (see Note 1)	J	$J = \frac{dP}{d\omega}$	watt per steradian	W sr ⁻¹
	Radiance (see Note 1)	N	$N = \frac{d^2P}{d\omega(dA \cos \Theta)}$ $N = \frac{dJ}{(dA \cos \Theta)}$	$\left\{ \begin{array}{l} \text{watt per steradian and} \\ \text{sq. cm} \\ \text{watt per steradian and} \\ \text{sq. m} \end{array} \right.$	W sr ⁻¹ cm ⁻² W sr ⁻¹ m ⁻²
PHOTOMETRIC	Luminous Efficacy	K	$K = \frac{F}{W}$	lumen per watt	lm W ⁻¹
	Luminous Efficiency	V	$V = \frac{K}{K_{\text{maximum}}}$		
	Luminous Energy (quantity of light)	Q_v	$Q_v = \int_{380}^{760} K(\lambda) Q_e \lambda d\lambda$	lumen-hour lumen-second (talbot)	lm h lm s
	Luminous Flux	F	$F = \frac{dQ_v}{dt}$	lumen	lm
	Luminous Emittance (see Note 2)	L	$L = \frac{dF}{dA}$	lumen per sq. ft	lm ft ⁻²
	Illumination (illuminance)	E	$E = \frac{dF}{dA}$	$\left\{ \begin{array}{l} \text{footcandle (lumen per sq. ft.)} \\ \text{lux (lumen per sq. m)} \\ \text{phot (lumen per sq. cm)} \end{array} \right.$	fc lx ph
	Luminous Intensity (candlepower)	I	$I = \frac{dF}{d\omega}$	candela (lumen per steradian)	cd
Luminance (brightness)	B	$B = \frac{d^2F}{d\omega(dA \cos \Theta)}$ $B = \frac{dI}{(dA \cos \Theta)}$	candela per unit area stilb (candela per sq. cm) nit (candela per sq. m) foot-Lambert (cd per π ft ²) apostilb (cd per π m ²) Lambert (cd per π cm ²)	cd in ⁻² , etc. sb nt ft-L asb L	

NOTES: 1. ω is a solid angle through which flux from point source is radiated

2. W and L refer to "emitted from" and H and E refer to "incident on"

Θ is angle between line of sight and normal to surface considered

λ is wavelength

distance away from the LED. Designers often make use of this parameter when choosing their infrared detectors. Silicon "solar cell" or "photovoltaic cell" detectors are the best detector choices because they generally have

large active areas, good long-term stability, and near-perfect match in spectral response compared with infrared LED sources, (see Figure 14).

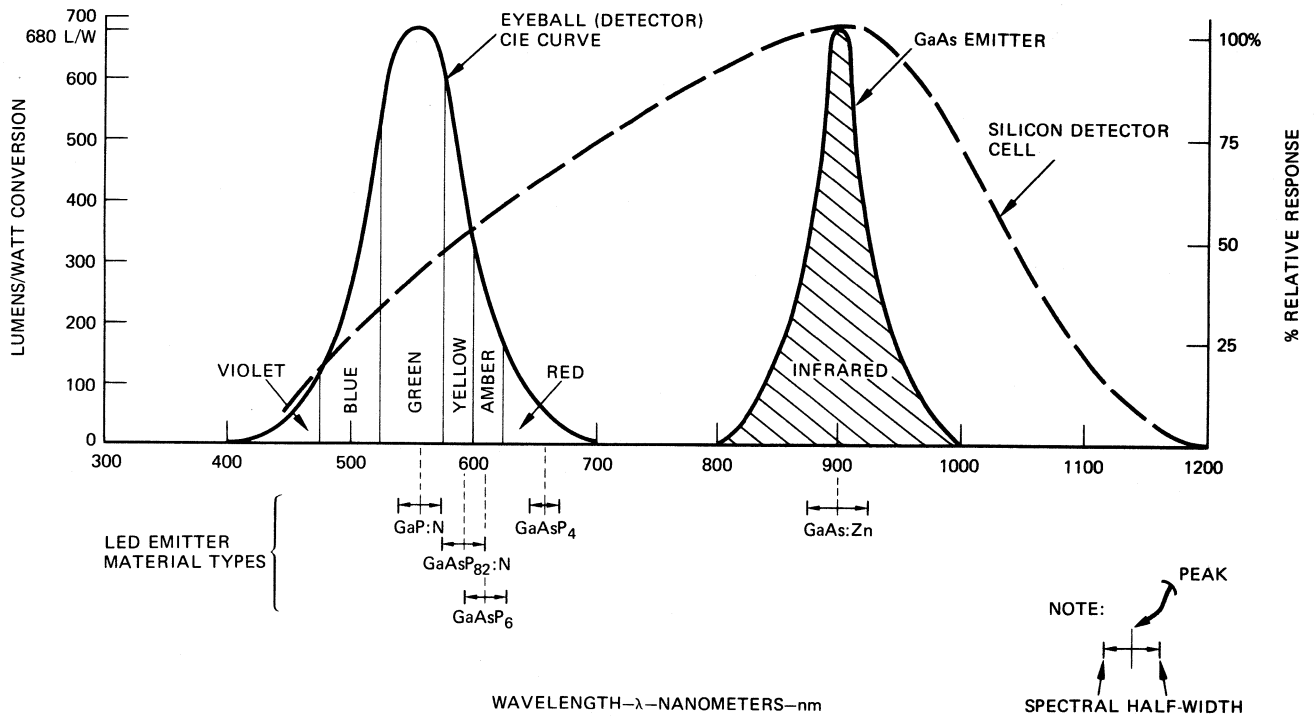


Fig. 14. Relationship Between LED and Detector Spectrums

C1162

AN602

measuring LED output

This Application Note serves to acquaint the reader with methods used by Monsanto to measure the emission produced by LED's. This Note defines the main LED parameters, explains measurement techniques and procedures, identifies instrumentation used, and describes test jigging. Also, it evaluates sources of measurement errors, points out approximations that are made, and discusses some practical limitations.

While methods described in this Application Note represent the best developed to date (September 1972), further improvements and refinements can be expected as LED technology continues to advance.

RADIATED POWER

Definition of Parameters. The term "flux" refers to the total amount of energy radiated in all directions per unit time from an electromagnetic source. The parameter "Total Radiated Output Power," (symbol "ROP" or "P"), refers to flux from an infrared-emitting LED. The measurement unit is the "watt." The parameter "Luminous Flux," (symbol "F"), refers to flux from a visible-emitting LED; the measurement unit is the "lumen."

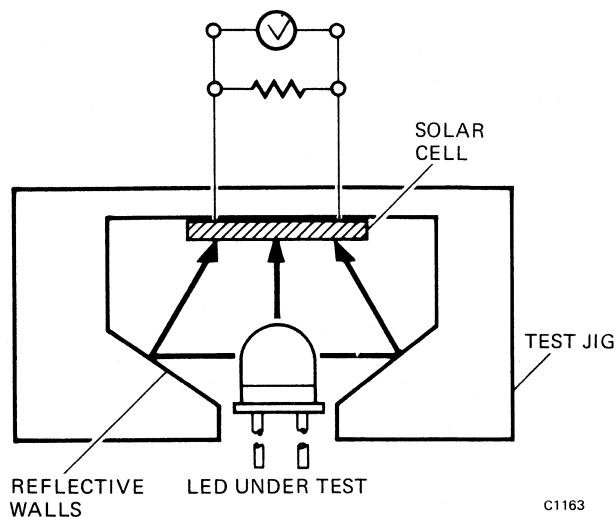
Measurement Techniques and Procedures. When placed within a jig with reflective walls, as shown in Figure 1, virtually the entire output of the LED falls upon the

silicon solar cell. The light generates a photoelectric current within the solar cell, and this current flows through a termination resistor. A meter monitors the voltage drop across the resistor and the meter scale is calibrated directly in "watts."

Output peak wavelength, λ_{peak} , of the LED under test must be known. This value of wavelength is needed for calculating a "sensitivity correction factor," which is applied to the meter reading. This procedure is necessary because solar cells do not respond uniformly for all wavelengths of light, (see Figure 2). For example, an LED producing 10 microwatts at λ_{peak} of 900 nanometers might cause the solar cell to generate more current than does an LED producing 10 microwatts at λ_{peak} equal to 800 nanometers.

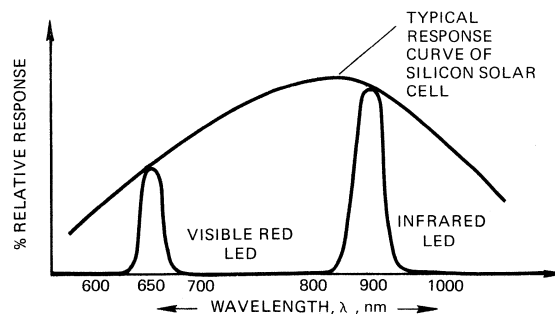
For LED's that produce emission at visible wavelengths, the readings in "watts" units must be converted into "lumens" units. The conversion is based upon wavelength and has been derived from empirical evaluations of the human eye's spectral response. The data generally accepted within the industry is known as the "CIE Curve" or "standard eyeball," and was established by Commission Internationale de l' Eclair. (For more details on CIE Curve, see AN601.) The formula used for this conversion is as follows:

$$\text{Luminous Flux (in lumens)} = \text{ROP (in watts)} \times \text{CIE lumens-per-watt Conversion Factor.}$$



C1163

Fig. 1. Diagram of Jigging for P and F Measurements



C1164

Fig. 2. Typical Spectral Response of Solar Cell Detector

Approximations and Sources of Error. In the above procedure the emission from the LED is assumed to be monochromatic, i.e., occurring at a single wavelength. In actuality, the emission does have a narrow spectral width and the "monochromatic" assumption can lead to measurement errors on the order of 10%, or greater.

A second source of error arises because some flux is lost within the jig, due to reflectance, absorption, and excessive angles of incidence for light reflected back into the LED lens.

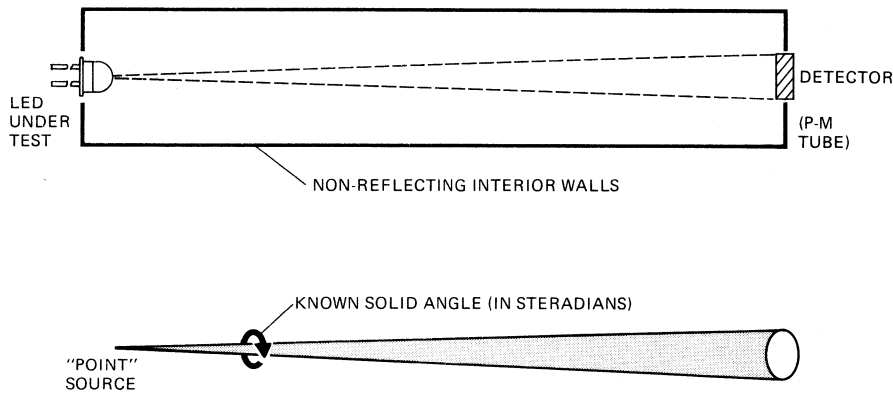
LUMINOUS INTENSITY

Definition of Parameter. The term "intensity" refers to amount of energy radiated in a given direction per unit time from an electromagnetic source. The parameter "Luminous Intensity;" (symbol "I"), refers to the intensity from a visible-emitting LED. The measurement unit is called "candela" (or "candle"), and one candela is equal to one lumen per unit solid angle (steradian).

Measurement Techniques and Procedures. Luminous Intensity measurements are quickly and easily made using a SPECTRA Model IV Microcandela Meter. The meter consists of a long tube (having non-reflecting interior walls) positioned in front of an electronic detector (photo-multiplier tube) (see Figure 3). The LED is placed in the end of the tube and a reading is obtained from the readout indicator. Because the distance from the LED to the detector—one foot—is sixty times the average diameter (0.2 inch) of an LED, the LED can be assumed (mathematically) to act as a "point" source, i.e., a source whose dimensions are negligible. The Luminous Intensity can be calculated from the formula,

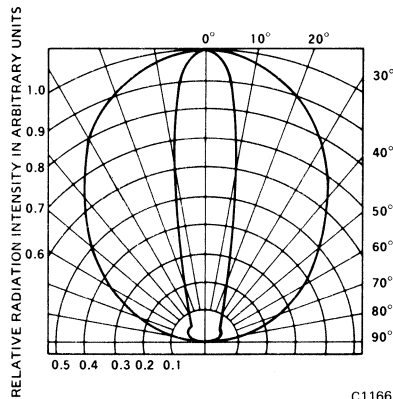
$$\text{Luminous Intensity (in candelas)} = \text{Correction Factor (in lumens-per-steradian)} \times \text{Detector Output}$$

The λ_{peak} of the LED must be known, and used to determine the magnitude of a Correction Factor.



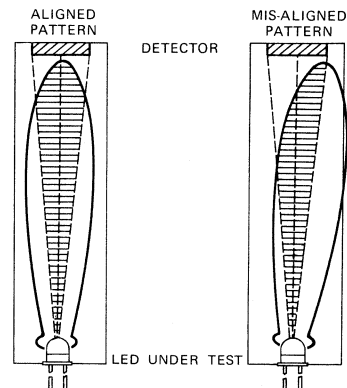
C1165

Fig. 3. Jigging for "I" Measurement



C1166

Fig. 4. Spatial Distribution Patterns for Two LED's



C1167

Fig. 5. Diagram Illustrating the Significance of Alignment

Approximations and Sources of Error. The repeatability of readings taken using this measurement technique can be dependent upon the positioning of the LED in the test socket. Because light emitted from each LED is spread over a given spatial distribution, (see Figure 4), the orientation of the LED determines the extent to which the distribution pattern aligns with the main axis of the test instrument, (see Figure 5). It can be seen that LED positioning is most critical for devices having a very narrow spatial distribution.

LUMINANCE

Definition of Parameter. The parameter "Luminance," (also sometimes called "Photometric Brightness"), refers to the ratio of Luminous Intensity contribution in a given direction to the area of the light source, (see Figure 6). Measurement units are given in "candelas per square unit" and many different-named units are in use, (see Table 1). An area light source whose spatial distribution pattern is spherical is called a "Lambertian Source," (see Figure 6a). Note that, because both Luminous Intensity readings and projected area vary with cosine θ , (see Figure 6b), "off-axis" Luminance readings are equal to "on-axis" readings for such a source.

Luminance is a practical parameter choice because source area—which in many instances the eye is able to detect—is introduced into the defining expression. In practice the "foot-Lambert" is the most-used unit of Luminance, but it is also the most abused, since it implies an assumption of a Lambertian distribution pattern (which does not hold for most LED's). Another Luminance measurement unit which does not assume a Lambertian distribution pattern is called "stilb," and is defined as follows:

$$\text{stilb} = \frac{\text{candelas}}{\text{area in cm}^2}$$

This measurement unit can be used for LED's having differing spatial distribution patterns.

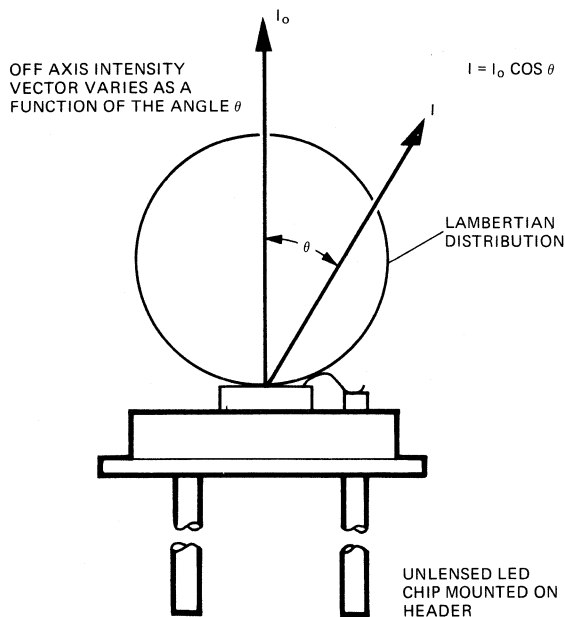


Fig. 6a. Lambertian Distribution

C1168

Measurement Techniques and Procedures. A Photo Research "Spot Brightness Meter" is used in conjunction with an L175 lens, (see Figure 7). The importance of the lens is that it determines the area to be measured. The L175 samples a circular area that is 0.008 inch in diameter. This dimension was chosen because most LED chips have active areas of this size or greater. The meter's indicator provides a direct Luminance reading in "foot-Lambert" units. (Luminance readings in "stilb" units can be derived from Luminous Intensity readings divided by Apparent Area, Ap.)

Approximations and Sources of Error. This method provides a good measurement of Luminance on devices having a clear lens (i.e., LED chip visible), but is less satisfactory on devices having lenses into which diffusants have been introduced. The repeatability of readings on devices having diffused lenses can be dependent upon positioning of the LED in the test socket (in the same manner as was described under Luminous Intensity measurements). Another source of error arises on LED's whose diffused lenses increase the apparent image size, say to 0.160 inch diameter. Then, it is often difficult (if not impossible) to repeatably pick up the same 0.008 inch diameter segment.

Care must be taken in definition of area. For clear lens devices use the active emitting area times lens magnification factor. For fully-flooded lens devices merely use the outside dimensions of the package. But devices with partially-diffused lenses present a different problem. An arbitrary solution is to define the size as one-half the outside package dimensions.

WAVELENGTH

Definition of Parameters. Wavelength, (symbol " λ "), is the name given to the basic characteristic of electromagnetic waves that describes distance that a wave travels during one complete cycle. Units most frequently used in light measurements are Angstroms, \AA

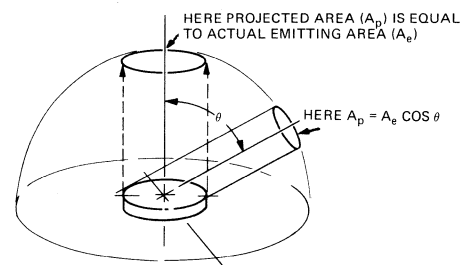


Figure 6b.

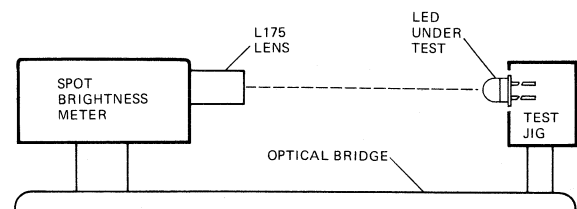


Fig. 7. Diagram of Luminance Measurement Method

C1169

(10^{-10} meters), and nanometer, nm, (10^{-9} meters). The parameter "Peak Emission Wavelength," (symbol " λ_{peak} "), refers to that value of wavelength in an LED emission spectrum which has the greatest energy content. The parameter "Spectral Line Half-Width" refers to the numerical difference between the value of shorter wavelength and the value of longer wavelength for which energy content is 50% of λ_{peak} , (see Figure 8).

Measurement Techniques and Procedures. Wavelength parameters can be measured using a Warner and Swasey Model 501 "Rapid Scanning Spectrometer" (or equivalent), together with an oscilloscope that displays the spectral wavelength information with wavelength linear in time, (see Figure 9). An internally calibrated radiation source permits the Model 501 to make absolute measurements of wavelength. It can also generate a display of change in wavelength distribution of energy as a function of time, i.e., energy spectrum. These capabilities are accomplished by means of various filters, gratings, and detectors. Wavelengths ranging from ultraviolet (at 2500 Angstroms) to infrared (at 14.5 microns) can be measured.

In addition to the analog oscilloscope display, a digital readout of wavelength can be obtained by using a type 2A63 Differential Comparator plug-in, calibrated for direct readout, in a Tektronix 565 Dual Beam oscilloscope (or equivalent). The "Delayed Sweep" feature of the oscilloscope is used to provide an intensity-modulated "bright spot" on the analog display. The Test Operator causes this "bright spot" to move along the displayed waveform by turning a front panel dial. A digital display continuously shows the numerical value of wavelength corresponding to the position of the "bright spot." In this way the Test Operator can obtain direct readouts of " λ_{peak} ," and λ_1 and λ_2 measurements for calculating "Spectral Line Half-Width."

Approximations and Sources of Error. Excellent correlation of readings between devices, and with wavelength standards, is possible. The positioning of the LED and dimensions of the jigg are not critical.

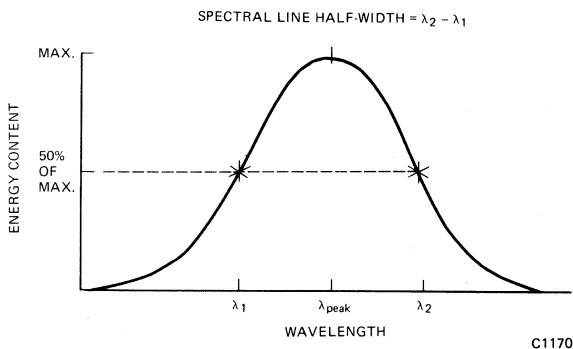


Fig. 8. " λ_{peak} " and "Spectral Line Half-Width" of an LED Emission Spectrum

PRACTICAL LIMITATIONS

This Application Note has described measurement methods by which a user can obtain parameter data on LED devices. However, human visual perception is a phenomenon having complex physiological-psychological aspects, and such engineering-type data alone are not adequate for completely predicting human performance. Also important, but at the same time impossible to quantify by conventional measurement methods, are such subjective factors as texture, color, sparkle, and even the viewer's emotional state (for example, performance during emergency, panic situations compared to that during routine, ordinary situations).

Therefore, while these measurement methods leave some room for further improvements and refinements, it would be too much to expect that they could ever provide perfect correlation with human performance.

$$\text{LUMINANCE} = \frac{\text{Luminous Intensity}}{A_p} = \frac{\text{lumens/steradian}}{A_e \cos \Theta} = \frac{\text{candelas}}{\text{(square unit)}}$$

Name of Unit	Definition
1 stilb	1 candela per cm^2
1 nit	1 candela per m^2
(no designator available)	1 candela per in^2
(no designator available)	1 candela per ft^2
Lambert	$(1/\pi)$ candela per cm^2
apostilb	$(1/\pi)$ candela per m^2
(or blondel)	
(no designator available)	$(1/\pi)$ candela per in^2
Foot-Lambert	$(1/\pi)$ candela per ft^2

Table 1. Names of Luminance Units

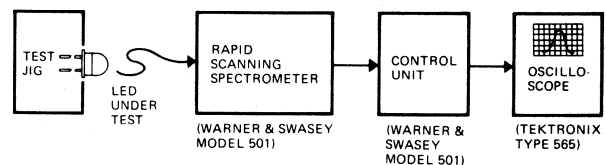


Fig. 9. Block Diagram of Wavelength Measuring Equipment

Monsanto

AN302 using LED's to replace incandescent lamps

High-density configurations of high-intensity incandescent lamps can generate considerable heat. For example, a 10-by-10 bank of miniature 50-volt lamps can dissipate 200 watts. The resulting heat can cause catastrophic damage to mounting sockets, shorten life of insulation material, weaken structural material, and make lamp replacement almost hazardous. LED's, on the other hand, not only run cooler but also use less power and have longer life. This Application Note points out some important electrical design considerations when using LED's as indicator lamps. Circuits that assure low power dissipation and protection for the LED's will be shown.

Note from the Editor: The author of this Note wrote from a point of view which subscribed to socketing off-the-shelf LED's. He realizes that various methods can be used to prohibit the inverse insertion of a polarized device into a symmetric socket, but chose to ignore these means for exemplification.

DEVICE MAXIMUM RATINGS

As in any circuit design, care must be taken not to exceed the maximum ratings of the components. In the case of LED's used as indicator lamps, the main absolute maximum parameters to be considered are Continuous Forward Current, I_F , and Reverse Voltage, V_R . Well-engineered circuit designs should protect the LED's from the consequences of being plugged into a socket in the reverse polarity, damage arising from voltage transients on the power supply, and inductive kicks of solenoids or relay coils. Table I lists some of the absolute maximum ratings for a typical LED solid-state indicator lamp, Monsanto's MV5054-2.

MONSANTO MV5054-2

Absolute Maximum Ratings at 100° C	Units
Reverse Voltage, V_R	5.0 V
Continuous Forward Current, I_F	15.0 mA
Peak Forward Current, I_p	6.0 A

Table I. Absolute Maximum Ratings of a Typical LED

SUPPLY VOLTAGE LESS THAN LED'S V_R MAX. RATING

The simple circuit shown in Figure 1 can be used in applications that have a DC supply voltage equal to or less than the V_R maximum rating of the LED. The resistance value of R1 can be calculated from the expression $R = 100 (V_{CC} - 2)$ when the I_F of the LED is to be 10mA. If the LED is plugged in so as to effect reverse polarity, no prohibitively high current flows since V_{CC} does not exceed the V_R max. of the LED.

Now consider what happens in Figure 1 if transient voltage spikes appear on the power supply line. Positive-going spikes cause I_F to increase, but cause no device problems since LED's can withstand very large positive-going spikes of short duration as they have extremely high Peak Forward Current, I_p , ratings. As long as the amplitude is less than V_{CC} , negative-going spikes merely reduce I_F ; if greater than $V_{CC} + V_R$, LED Reverse Current, I_R , can become very large and device damage can result. Those applications in which negative-going spikes of amplitude greater than $(V_R + V_{CC})$ can occur should have a silicon diode added, either in-series (Figure 2) or in parallel (Figure 3) with the LED.

The "+ V_{CC} " of Figures 1, 2, and 3 just described can, of course, be half-wave or full-wave rectification as well as DC (provided that the peak does not exceed +5 volts).

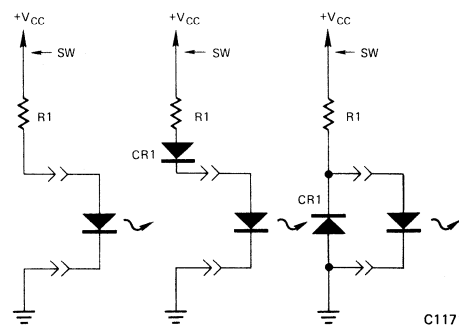


Figure 1

Figure 2

Figure 3

NOTES:

R1 is 1/4w., ±5%, composition resistor
CR1 is 1N914 or equivalent silicon diode

"SW" indicates recommended location of series switch or relay contact
"⊥" indicates ground return of + V_{CC} or output of NAND/NOR logic gate

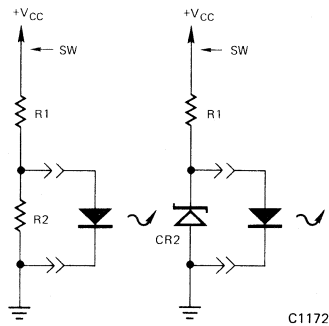


Figure 4

Figure 5

NOTES:

R1 is 1/4 to 1 w., ±5%, composition resistor
 R2 is 1/4 w., ±5%, composition resistor
 CR2 is 5 volt, ±20%, 250 mw., low-cost zener

"SW" indicates recommended location of series switch or relay contact
 "⊥" indicates ground return of +V_{CC} or output of NAND/NOR logic gate

SUPPLY VOLTAGE GREATER THAN LED'S V_R MAX. RATING

An LED plugged in the inverse polarity in Figure 1, 2, or 3 can be damaged by high I_R if the supply voltage is greater than the V_R maximum rating of the LED. To protect against possible damage, an additional component must be added. Figure 4 shows a circuit having an additional resistor, R2, whose function is to limit the voltage drop to the V_R max. of the LED when no LED is plugged in.

DESIGN EXAMPLE: Suppose that an MV5054-2 LED is to be used in an application having a V_{CC} of 50 volts and an I_F of 10mA. When no LED is plugged in, R2's voltage drop is to be less than 5 volts (the V_R maximum rating listed in Table I for a MV5054-2).

Standard values of 3300 ohms for R1 and 360 ohms for R2 are obtained from a simple Thevenin's Theorem equivalent circuit, as:

$$\frac{V_R \text{ max.} - V_F (\text{typ.})}{I_F} = \frac{R_1 R_2}{R_1 + R_2}, \text{ where } R_1 = 9 R_2$$

$$\frac{5 - 1.8}{.01} = \frac{R_1 R_2}{R_1 + R_2} = \frac{9 R_2}{10}, \text{ etc.}$$

Note that Figure 4's circuit also provides protection against damage from negative-going voltage spikes of amplitudes greater than V_R + V_{CC}.

The circuit shown in Figure 5 can protect the LED against incorrect socketing as well as against voltage spikes of virtually any amplitude. The value of the zener diode's breakdown voltage is chosen to be less than the V_R maximum but greater than V_F maximum of the LED. When no LED is plugged in, the zener conducts with a breakdown voltage less than V_R. An LED plugged in with the wrong polarity is not stressed because the voltage applied across its terminals is less than its V_R

maximum rating. Figure 5's circuit provides protection against negative-going voltage spikes since a spike of amplitude greater than V_{CC} put the zener into forward conduction, holding the reverse voltage across the terminals of the LED to no more than one volt.

Notice that the "+V_{CC}" of Figures 4 and 5 can be half-wave or full-wave rectification (or for that matter just plain AC) so long as the peak voltage does not exceed 50 volts. Figure 4, if driven by AC, gives an effect that the LED is non-polarized and will operate no matter how inserted in the socket.

HIGH-DENSITY LAMP CONFIGURATIONS

At the beginning of this Application Note it was pointed out that a 10-by-10 bank of miniature 50-volt incandescent lamps can dissipate 200 watts. Besides running cooler than incandescents, LED indicator lamps can be used in circuit designs that reduce power dissipated at the socket. Consider the circuit shown in Figure 6 for a 20-lamp bank operating from a 50-volt, ±5% power source. Here the Q1, CR3 portion of the circuit acts as an equivalent 40-volt zener, and can be located easily on a heat sink remote from the lamp sockets. The amount of power dissipated at each socket—LED plus resistors—is less than one-fifth watt, rather than the incandescent lamp's two watts.

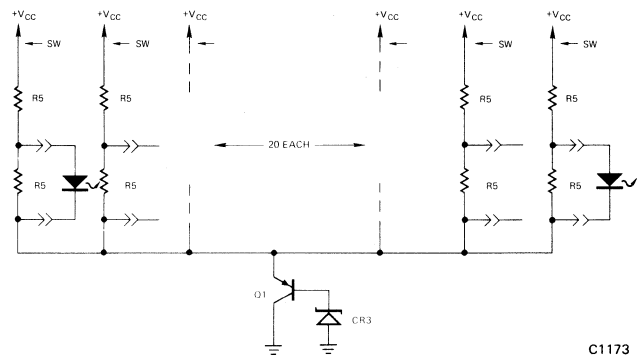


Figure 6

NOTES:

R5 is 680 ohm, 1/2 w., ±5%, composition resistor
 Q1 is 10 w., PNP transistor

CR3 is 39 volt, ±5%, 1 w. zener
 "SW" indicates recommended location of series switch or relay contact

Although a Monsanto MV5054-2 LED has been used in all circuits shown in this Application Note, the same design considerations apply to other LED types as well.

Monsanto

AN303 MOS logic level indicator

Monsanto has developed a very low current LED capable of being driven directly from MOS and COS integrated circuits. Designated the MV55, this visible red LED incorporates a new chip, specially designed for operation at low current levels. The MV55 typically produces a Brightness of more than 100 ft-Lamberts from a Forward Current of only 1 mA. This Brightness is adequate for indicating binary logic level, especially in the subdued ambient lighting environment commonly found within cabinet- or chassis-mounted equipment.

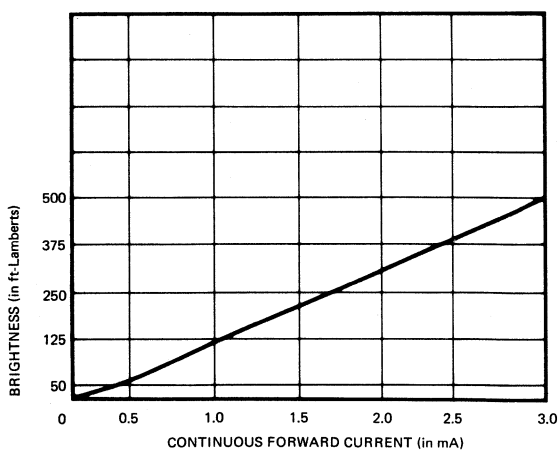
ELECTRICAL CHARACTERISTICS

The Brightness versus Continuous Forward Current relationship for a typical MV55 is shown in Figure 1. In steady-state operation the MV55 has an absolute maximum Continuous Forward Current rating of 4 mA, and in pulsed operation (with one microsecond pulse width

and 0.1% duty cycle) an absolute maximum Peak Forward Current rating of 400 mA. For Reverse Voltage the MV55 has a 3.0 volt absolute maximum rating, and "turn-on" and "turn-off" times (with a one-ohm load impedance) are typically one nanosecond, (10^{-9} seconds).

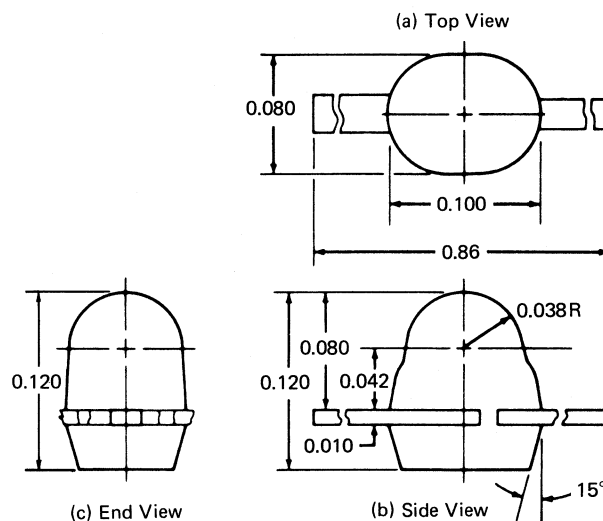
MECHANICAL CHARACTERISTICS

The MV55's package has an axial-lead form factor (see Figure 2). Its very small size minimizes space requirements, permitting high-density P.C. Board layouts. The MV55 is simple to install, since mounting sockets or other hardware are not required. The ribbon-type leads can be either soldered or welded. The low profile of the package enables edge-board or flat-board mounting. (Arrangements can be made to have leads custom pre-bent prior to shipment from the factory.)



C1174

Fig. 1. Brightness versus Continuous Forward Current
for typical MV55



NOTES: 1) DIMENSIONS SHOWN ARE NOMINAL VALUES (IN INCHES)
2) DOTTED LINES INDICATE CENTRAL MECHANICAL AXIS

C1175

Fig. 2. MV55 Package

LENS CHARACTERISTICS

The MV55 has a red, fully-diffused plastic lens which collects the LED output into a narrow spatial distribution pattern (see Figure 3). For MV55 devices the axis of spatial distribution is typically within a 10° cone with reference to the central mechanical axis of the package. This lens assures high Luminous Intensity along the axis of spatial distribution.

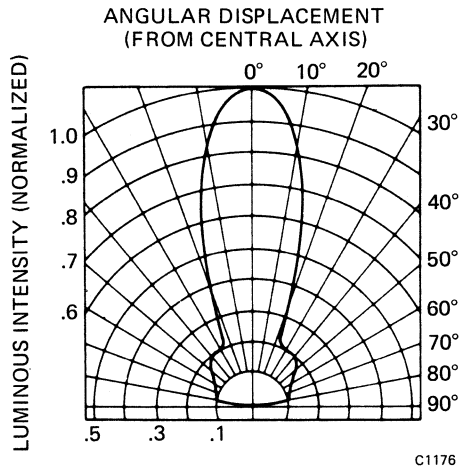


Fig. 3. Spatial Distribution Pattern for MV55

BASIC CIRCUITS

Some basic circuits for the MV55 are shown in Figure 4. Note that this LED does not require buffering or interface stages, but merely connects directly to the IC output. The choice between the circuits shown in Figure 4a and 4b is made according to whether the LED is to light when the IC output state is at logical "1," or at logical "0." In Figure 4c's circuit the MV55 not only performs as an indicator, but also presents a high impedance to the TTL gate when the MOS output is at logical "0."

CONCLUSION

This Application Note has briefly pointed out the main features of the MV55 and has shown circuits in which it can be used. The MV55 not only offers the high reliability and long lifetime inherent in solid state devices, but also has low unit cost.

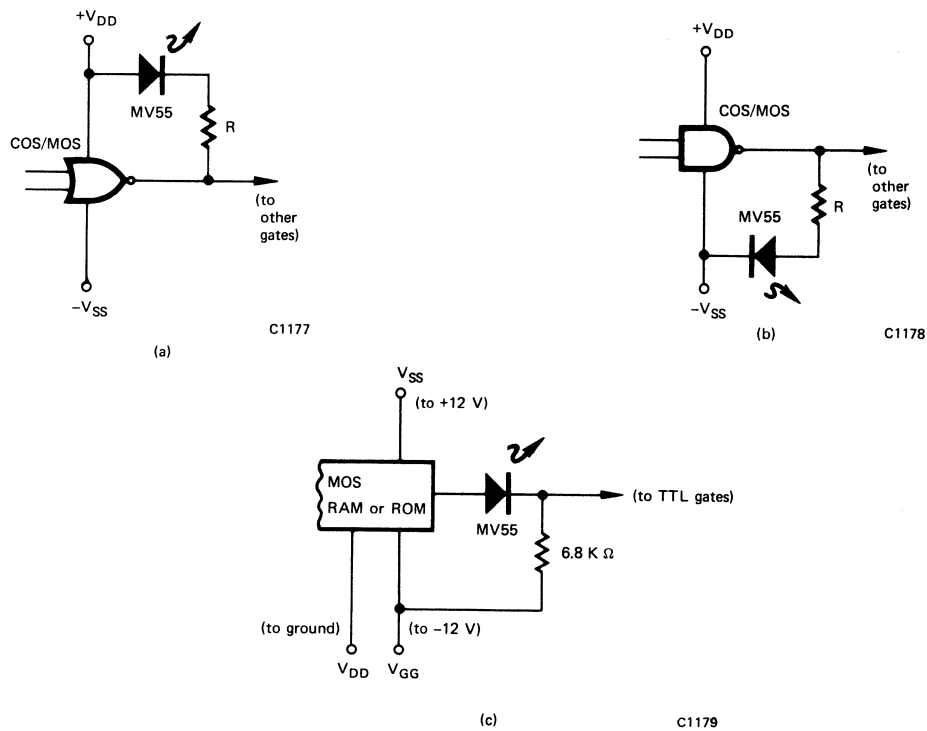


Fig. 4. Basic Circuits for MV55

3

DISCRETE LED LAMPS

Discrete LED Lamps

QUICK REFERENCE CHART

Monsanto offers a broad line of discrete light emitting diode products to provide the customer with a wide selection of off-the-shelf products that will meet his particular requirements. A broad selection of packages, lens effects, color power,

and brightness is available from standard distribution channels in virtually all quantities. These lines are being updated continually to provide modern, functional devices for customer use.

MODEL NO.	VIEWED COLOR	SOURCE WAVE-LENGTH	FORWARD VOLTAGE	BRIGHTNESS NO. AND UNITS	TEST @ CURR. (If)	REVERSE CURRENT	MAX. FORWARD CURRENT @ 25°C	MAX. POWER
MV10B	Red	(660) nm	1.65 V	0.8 mcd	10 mA	50 nA	70 mA	175 mW
MV50	Red	(660) nm	1.65 V	1.4 mcd	20 mA	5.0 nA	40 mA	80 mW
MV52	Green	(565) nm	2.2 V	1.5 mcd	50 mA	100 μ A max.	35 mA	105 mW
MV53	Yellow	(589) nm	2.1 V	1.5 mcd	50 mA	100 μ A max.	35 mA	105 mW
MV54	Red	(660) nm	1.65 V	1.0 mcd	20 mA	5.0 nA	40 mA	80 mW
MV55	Red	(660) nm	1.6 V	0.5 mcd	3 mA	150 nA	4 mA	6 mW
MV5020	Red	(660) nm	1.65 V	2.0 mcd	20 mA	15 nA	100 mA	180 mW
MV5021	Red	(660) nm	1.65 V	1.6 mcd	20 mA	15 nA	100 mA	180 mW
MV5022	Red	(660) nm	1.65 V	1.6 mcd	20 mA	15 nA	100 mA	180 mW
MV5023	Red	(660) nm	1.65 V	1.6 mcd	20 mA	15 nA	100 mA	180 mW
MV5024	Red	(660) nm	1.65 V	3.0 mcd	20 mA	15 nA	100 mA	180 mW
MV5025	Red	(660) nm	1.65 V	0.4 mcd	20 mA	15 nA	100 mA	180 mW
MV5026	Red	(660) nm	1.65 V	0.6 mcd	20 mA	15 nA	100 mA	180 mW
MV5050	Red	(660) nm	1.7 V	2.0 mcd	20 mA	20 nA	100 mA	180 mW
MV5051	Red	(660) nm	1.7 V	1.6 mcd	20 mA	15 nA	100 mA	180 mW
MV5052	Red	(660) nm	1.7 V	2.0 mcd	20 mA	5 nA	100 mA	180 mW
MV5053	Red	(660) nm	1.7 V	1.6 mcd	20 mA	5 nA	100 mA	180 mW
MV5054-1	Red	(660) nm	1.8 V	2.0 mcd	10 mA	100 nA	100 mA	180 mW
MV5054-2	Red	(660) nm	1.8 V	3.0 mcd	10 mA	100 nA	100 mA	180 mW
MV5054-3	Red	(660) nm	1.8 V	4.0 mcd	10 mA	100 nA	100 mA	180 mW
MV5055	Red	(660) nm	1.7 V	0.6 mcd	20 mA	5 nA	100 mA	180 mW
MV5056	Red	(660) nm	1.7 V	0.8 mcd	20 mA	5 nA	100 mA	180 mW
MV5074B/C	Red	(660) nm	1.68 V	2.4 mcd	20 mA	15 nA	50 mA	100 mW
MV5075B/C	Red	(660) nm	1.68 V	1.5 mcd	20 mA	15 nA	50 mA	100 mW
MV5077B/C	Red	(660) nm	1.6 V	1.7 mcd	20 mA	15 nA	50 mA	100 mW
MV5152	Orange	(635) nm	2.0 V	40 mcd	20 mA	20 nA	35 mA	105 mW
MV5153	Orange	(635) nm	2.0 V	9.0 mcd	20 mA	20 nA	35 mA	105 mW
MV5154	Orange	(635) nm	2.0 V	10.0 mcd	20 mA	20 nA	35 mA	105 mW
MV5252	Green	(565) nm	2.2 V	11 mcd	20 mA	20 nA	35 mA	105 mW
MV5253	Green	(565) nm	2.2 V	3.5 mcd	20 mA	20 nA	35 mA	105 mW
MV5254	Green	(565) nm	2.2 V	3.0 mcd	20 mA	20 nA	35 mA	105 mW
MV5352	Yellow	(585) nm	2.1 V	40 mcd	20 mA	20 nA	35 mA	105 mW
MV5353	Yellow	(585) nm	2.1 V	8.0 mcd	20 mA	20 nA	35 mA	105 mW
MV5354	Yellow	(585) nm	2.1 V	10.0 mcd	20 mA	20 nA	35 mA	105 mW
MV5752	Orange	(635) nm	2.0 V	40 mcd	20 mA	20 nA	35 mA	105 mW
MV5753	Hi. Eff. Red	(635) nm	2.0 V	9.0 mcd	20 mA	20 nA	35 mA	105 mW
MV5754	Hi. Eff. Red	(635) nm	2.0 V	10.0 mcd	20 mA	20 nA	35 mA	105 mW
MV5174B/C	Orange	(635) nm	2.0 V	3.5 mcd	20 mA	20 nA	35 mA	105 mW
MV5177B/C	Orange	(635) nm	2.0 V	2.4 mcd	20 mA	20 nA	35 mA	105 mW
MV5274B/C	Green	(565) nm	2.2 V	1.8 mcd	20 mA	20 nA	35 mA	105 mW
MV5277B/C	Green	(565) nm	2.2 V	0.9 mcd	20 mA	20 nA	35 mA	105 mW
MV5374B/C	Yellow	(585) nm	2.1 V	2.5 mcd	20 mA	20 nA	35 mA	105 mW
MV5377B/C	Yellow	(585) nm	2.1 V	2.0 mcd	20 mA	20 nA	35 mA	105 mW
MV5774B/C	Hi. Eff. Red	(635) nm	2.0 V	3.5 mcd	20 mA	20 nA	35 mA	105 mW
MV5777B/C	Hi. Eff. Red	(635) nm	2.0 V	2.4 mcd	20 mA	20 nA	35 mA	105 mW
MV5094	Red/Red (Note a)		1.6 V	0.8 mcd	20 mA	15 nA	70 mA	140 mW
MV5491	Red/Green (Note b)							
	Red Diode		1.65 V	1.5 mcd	20 mA	15 nA	70 mA	200 mW
	Green Diode		3.0 V	0.5 mcd	20 mA	100 μ A max.	35 mA	200 mW
MV53124	Yellow	(585) nm	2.0 V	4.0 mcd	20 mA	20 nA	35 mA	105 mW
MV57124	Red	(635) nm	2.0 V	4.0 mcd	20 mA	20 nA	35 mA	105 mW

NOTES:

- (a) The MV5094 contains two red diodes connected inversely parallel. Therefore the unit operates on either polarity DC current or AC current. Wavelength is 660 nm. For this unit, I^2T (0.1% duty cycle $\dots 2.5 \times 10^{-4}$ amps² sec).
- (b) The MV5491 contains one red and one green diode connected inversely parallel. Therefore the unit emits green light (570 nm) with one DC polarity and red light (660 nm) with the opposite DC polarity.

All specifications are typical unless otherwise specified.

Monsanto

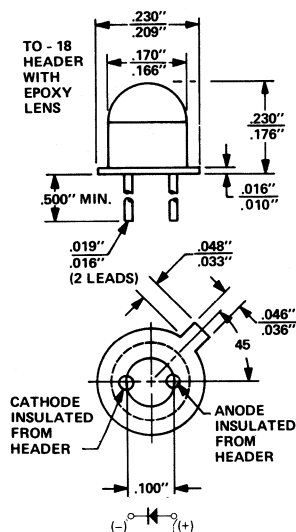
MV10B

RED LED

PRODUCT DESCRIPTION

The MV10B is a GaAsP light emitting diode mounted on a TO18 header with a clear epoxy lens. On forward bias, it emits a spectrally narrow band of radiation which peaks at 660 nm.

PACKAGE DIMENSIONS



FEATURES

- High Efficiency
- Ultra High Brightness
- Long Life — Solid State Reliability
- Low Power Requirements
- Compatible with Integrated Circuits — DTL, RTL, T²L.
- Compact, Rugged, Lightweight.

ABSOLUTE MAXIMUM RATINGS

Power Dissipation @ 25°C Ambient Temperature	175mW
Derate Linearly from 25°C	2.33mW/°C
Storage & Operating Temperature	-55°C to +100°C
Lead Solder Time @260°C (see note 4)	7.0 s
Continuous Forward Current	70mA
Peak Forward Current (1 μsec pulse, 0.3% duty cycle)	1.0A
Reverse Voltage	5.0V

ELECTRO-OPTICAL CHARACTERISTICS

(25°C Free Air Temperature Unless Otherwise Specified)

CHARACTERISTICS	MIN.	TYP.	MAX.	UNITS	TEST CONDITIONS
Brightness (see note 1) (B)		600		ft-L	I _F = 50 mA
Luminous-Intensity (I)		0.8		mcd	I _F = 10 mA
Total external radiated power (see note 2)		90		μW	I _F = 50 mA
Peak emission wave length	630	660	700	nm	
Spectral line half width		20		nm	
Forward voltage		1.65	2.0	V	I _F = 50 mA
Forward dynamic resistance		2.0		Ω	I _F = 50 mA
Capacitance		135		pF	V = 0

ELECTRO-OPTICAL CHARACTERISTICS (Continued)

CHARACTERISTICS	MIN.	TYP.	MAX.	UNITS	TEST CONDITIONS
Light rise time and fall time		50		ns	50Ω system, I _F = 50 mA
Reverse current		50		nA	V _R = 3.0 V
Reverse breakdown voltage	3	15		V	I _R = 100 μA
Luminous Flux		3.7		mLumens	I _F = 50 mA
View angle		90		Degrees	Between 50% Points

TYPICAL THERMAL CHARACTERISTICS

Thermal Resistance Junction to Free Air (θ_{JA})	320° C/W
Thermal Resistance Junction to Case (θ_{JC})	155° C/W
Wavelength Temperature Coefficient (case temperature)	0.3 nm/°C
Forward Voltage Temperature Coefficient	-2.0 mV/°C

TYPICAL ELECTRO-OPTICAL CHARACTERISTICS CURVES

(25°C Free Air Temperature Unless Otherwise Specified)

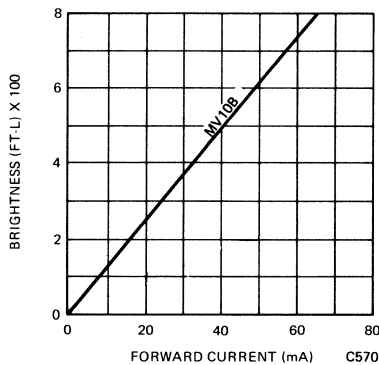


Figure 1 Brightness vs. Forward Current

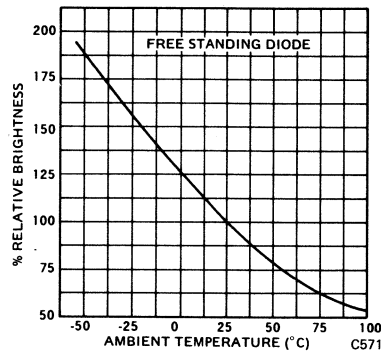


Figure 2 Brightness vs. Temperature

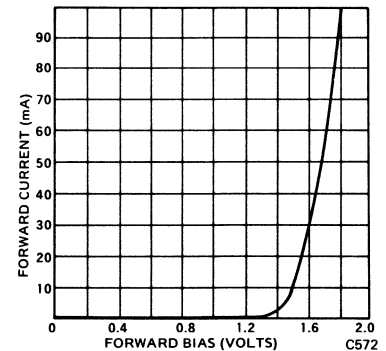


Figure 3 Forward Current vs. Forward Voltage

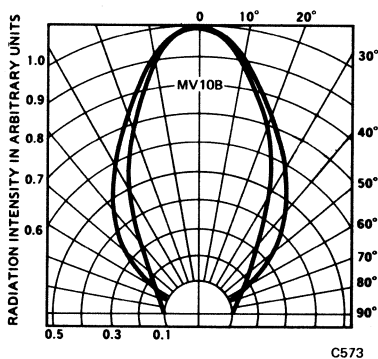


Figure 4 Spatial Distribution (Note 5)

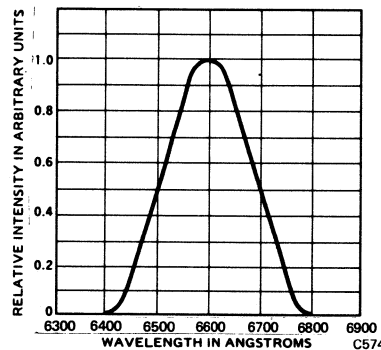


Figure 5 Spectral Distribution

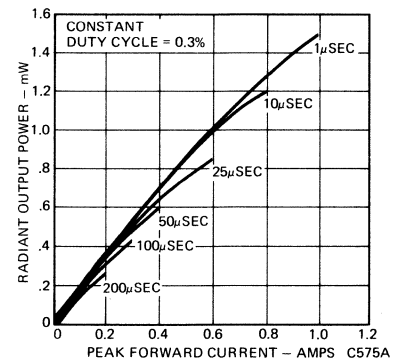


Figure 6 Peak Power Output vs. Pulsed Forward Current

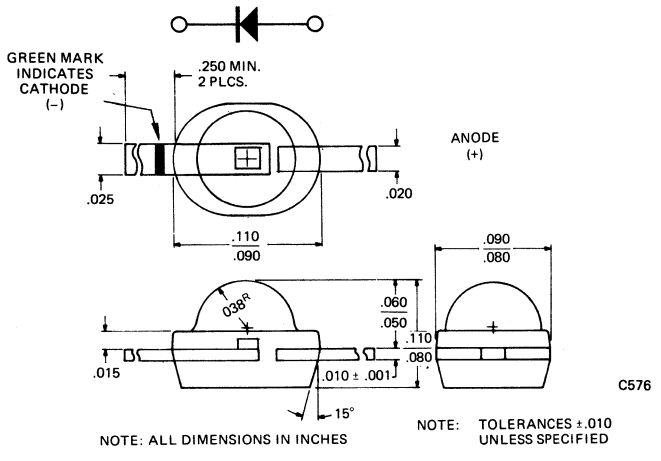
NOTES

- As measured with a Photo Research Spectra Spot Brightness Meter with "Spectar" L-175 lens in the brightest region of the emitting surface.
- The total external power output measurements are made with a Centralab 100C solar cell terminated into a 100 ohm impedance.
- The apparent spot size diameter for the MV10B is 0.028-inch.
- The leads of the MV10B were immersed in molten solder, heated to 260°C, to a point 1/16-inch from the body of the device per MIL-S-750.
- The axis of spatial distribution are typically within a 10° cone with reference to the central axis of the device.

PRODUCT DESCRIPTION

The MV50 is a diffused Gallium Arsenide Phosphide diode mounted in a two lead water clear epoxy package. On forward bias it emits a spectrally narrow band of visible light which peaks at 660 nm.

PACKAGE DIMENSIONS



FEATURES

The MV50 is intended for high volume indicator light applications where low cost, high reliability, and top performance are required. Major usage is in applications such as diagnostic lights on printed circuit boards and panel lights. The MV50 can be used to displace sub-miniature lamps as small as T3/4 size.

- Low cost
- Bright
- Compatible with integrated circuits
- Long life, rugged
- Small size - T3/4
- Easily assembled in arrays

ABSOLUTE MAXIMUM RATINGS

Power dissipation @ 25°C ambient.	80 mW
Derate linearly from 25°C	1.0 mW/°C
Storage and operating temperature	-55°C to 100°C
Peak forward current (1 μsec pulse width, 0.3% duty cycle)	1.0A
Lead solder time @ 230° (note 1)	5 sec
Continuous forward current	40 mA
Reverse Voltage	5.0 V

ELECTRO-OPTICAL CHARACTERISTICS

CHARACTERISTICS	MINIMUM	TYPICAL	MAXIMUM	UNITS	TEST CONDITIONS
Luminous Intensity (I) (note 3)*	0.5	1.4		mcd	I _F = 20 mA
Total external radiated power		60		μW	I _F = 20 mA
Peak emission wavelength	630	660		nm	I _F = 20 mA
Spectral line halfwidth		20		nm	I _F = 20 mA
Forward voltage		1.65	2.0	V	I _F = 20 mA
Capacitance		80		pF	V = 0
Light rise and fall time		50		ns	50Ω system, I _F = 20 mA
Reverse current		5.0		nA	V _R = 3.0 V
Reverse breakdown voltage	5	15		V	I _R = 100 μA
Luminous flux		1.6		mL	I _F = 20 mA
View angle		80		degrees	50% points

*Luminous intensity guaranteed to a 2.5% AQL inspection plan per MIL-STD-105D.

TYPICAL THERMAL CHARACTERISTICS

Wavelength temperature coefficient (case temperature) 0.3 nm/°C
 Forward voltage temperature coefficient -2.0 mV/°C

TYPICAL ELECTRO-OPTICAL CHARACTERISTIC CURVES

(25°C Free Air Temperature Unless Otherwise Specified)

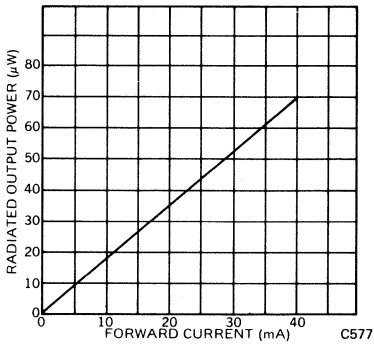


Figure 1 ROP vs. Forward Current

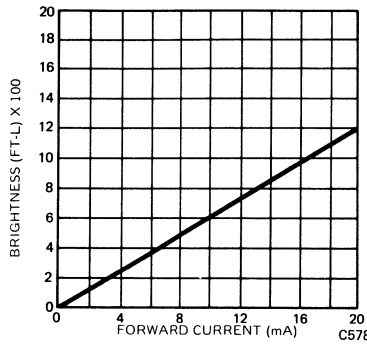


Figure 2 Brightness vs. Forward Current

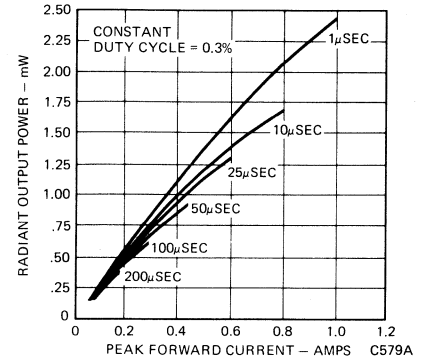


Figure 3 Peak Power Output vs. Pulsed Forward Current

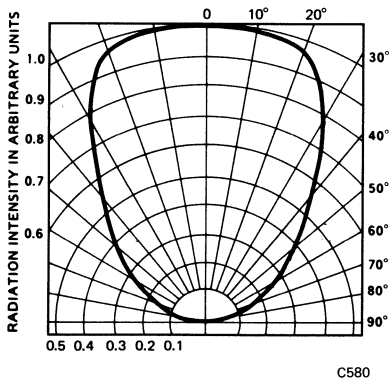


Figure 4 Spatial Distribution (Note 4)

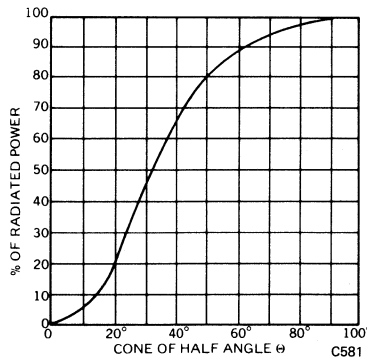


Figure 5 Percent Radiated Power Into Cone of Half Angle

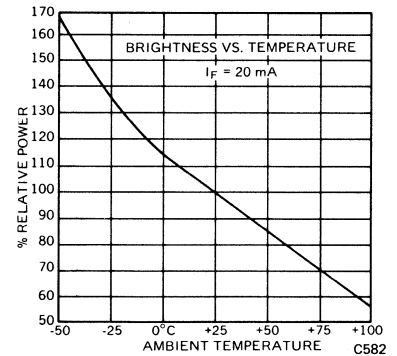


Figure 6 Relative Power vs. Temperature

NOTES

1. The leads of the device were immersed in molten solder at 260°C to a point 1/16 inch from the body of the device per MIL-S-750.
2. As measured with a photo Research Spectra Spot Brightness Meter with "Spectar" L-175 lens in the brightest region of the emitting surface.
3. As measured with a Photo Research Corp. Microcandela Meter (Model IV D).
4. The axis of spatial distribution are typically within a 10° cone with reference to the central axis of the device.

Monsanto

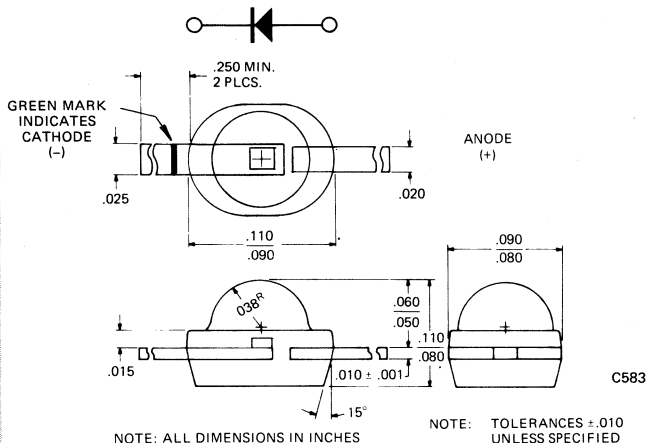
MV52 MV53

GREEN AND YELLOW LIGHT EMITTING DIODES

PRODUCT DESCRIPTION

The MV52 is a Gallium Phosphide diode mounted in a two lead green epoxy package. The MV53 is a Gallium Arsenide Phosphide diode mounted in a two lead yellow epoxy package. The identical mechanical configuration is also available in a red lamp, part number MV50 or MV54.

PACKAGE DIMENSIONS



FEATURES

The MV52 and MV53 units are intended for high volume indicator light applications where high reliability and top performance are required. Major usage is in applications such as diagnostic lights on printed circuit boards and panel lights. The units can be used to displace subminiature lamps as small as T3/4 size.

- MULTICOLORED VERSIONS OF THE POPULAR MV50 PACKAGE
- Low cost
- Bright
- Compatible with integrated circuits
- Long life, rugged
- Small size — T3/4

ABSOLUTE MAXIMUM RATINGS

Power dissipation @ 25°C ambient	105 mW
Derate linearly from 25°C	1.3 mW/°C
Storage and operating temperature	-55°C to 100°C
Lead solder time @ 230°C	5 sec
Continuous forward current	35 mA
Reverse Voltage	5.0 V

ELECTRO-OPTICAL CHARACTERISTICS

CHARACTERISTICS	MINIMUM	TYPICAL	MAXIMUM	UNITS	TEST CONDITIONS
Luminous Intensity (I) (Note 1)*	0.2	1.0		mcd	$I_F = 20 \text{ mA}$
Peak emission wavelength, MV52	550	565	575	nm	$I_F = 20 \text{ mA}$
Peak emission wavelength, MV53	580	589	600	nm	$I_F = 20 \text{ mA}$
Spectral line halfwidth MV52, MV53		35		nm	$I_F = 20 \text{ mA}$
Forward voltage MV52		2.2	3.0	V	$I_F = 20 \text{ mA}$
MV53		2.1	3.0	V	$I_F = 20 \text{ mA}$
Reverse breakdown voltage	5	15		V	$I_R = 100 \mu\text{A}$
Forward voltage temp. coefficient		-3.0		mV/°C	$I_F = 20 \text{ mA}$

*Luminous intensity guaranteed to a 2.5% AQL inspection plan per MIL-STD-105D.

TYPICAL ELECTRO-OPTICAL CHARACTERISTIC CURVES

(25°C Free Air Temperature Unless Otherwise Specified)

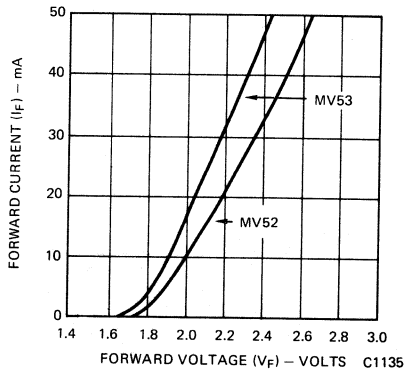


Fig. 1. Forward Current vs. Forward Voltage

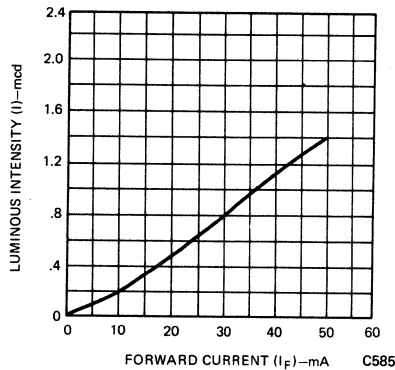


Fig. 2. Luminous Intensity vs. Forward Current

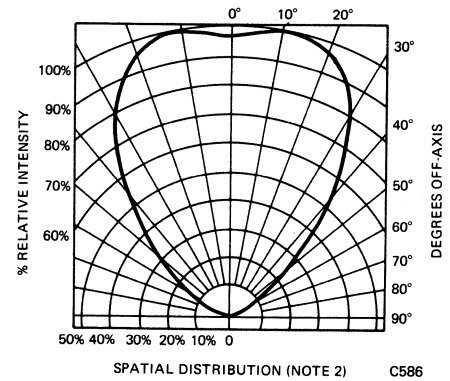


Fig. 3. Spatial Distribution (Note 2)

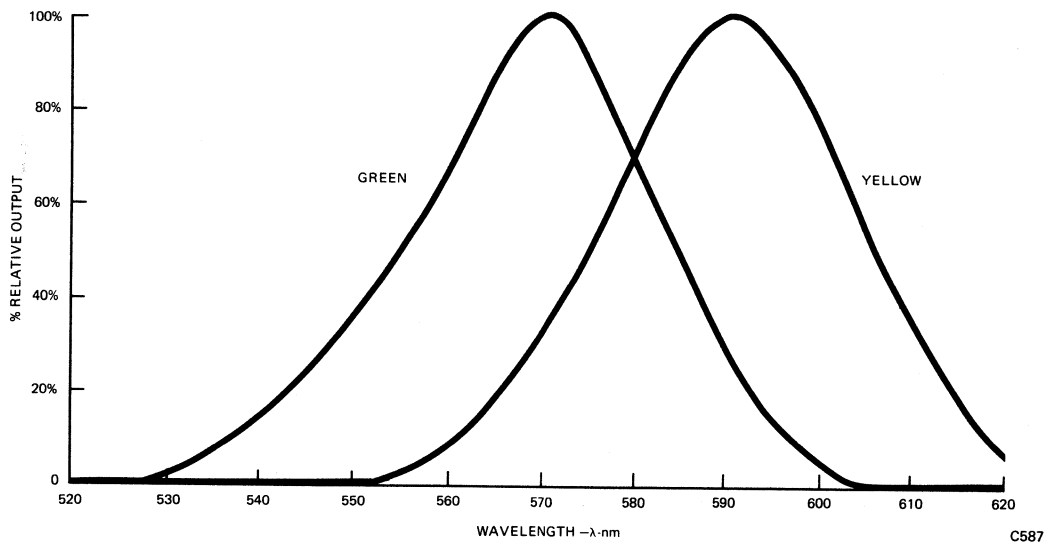


Fig. 4. MV52-MV53 Spectral Response

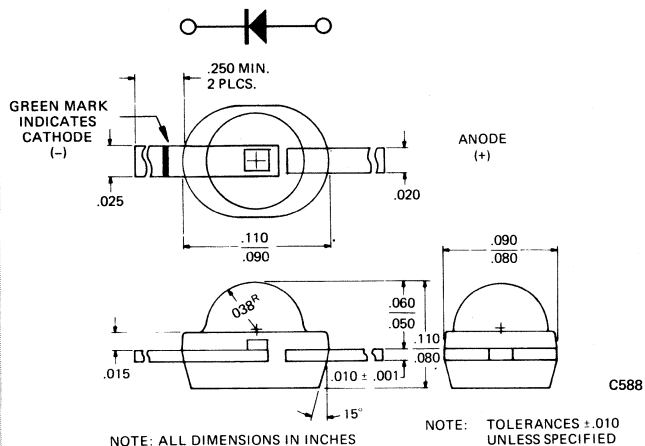
NOTES

1. As measured with a Photo Research Corp. Microcandela Meter (Model IV D).
2. The axis of spatial distribution are typically within a 10° cone with reference to the central axis of the device.

PRODUCT DESCRIPTION

The MV54 is a diffused Gallium Arsenide Phosphide diode mounted in a two lead epoxy package. The lens is red diffused epoxy, and the outline is identical to the MV50.

PACKAGE DIMENSIONS



FEATURES

The MV54 is intended for high volume indicator light applications where low cost, high reliability, and top performance are required. Major usage is in applications such as diagnostic lights on printed circuit boards and panel lights. The MV54 can be used to displace sub-miniature lamps as small as T3/4 size.

- Low cost
- Bright
- Compatible with integrated circuits
- Long life, rugged
- Small size - T3/4
- Easily assembled in arrays

ABSOLUTE MAXIMUM RATINGS

Power dissipation @ 25°C ambient	80 mW
Derate linearly from 50°C	1.6 mW/°C
Storage temperature	-55°C to 100°C
Operating temperature	-55°C to 100°C
Lead solder time @ 230°C (note 1)	5 sec
Continuous forward current	40 mA
Reverse voltage	5.0 V

ELECTRO-OPTICAL CHARACTERISTICS

	MINIMUM	TYPICAL	MAXIMUM	UNITS	TEST CONDITIONS
Brightness (Note 2)*	0.4	1.0		mcd	I _F =20 mA
Total external radiated power		38		μW	I _F =20 mA
Peak emission wavelength	630	660		nm	I _F =20 mA
Spectral line halfwidth		20		nm	I _F =20 mA
Forward voltage		1.65	2.0	V	I _F =20 mA
Capacitance		80		pF	V=0
Light rise and fall time		50		ns	Z = 50Ω system I _F =50 mA
Reverse current		5.0		nA	V _R =3.0 V
Reverse breakdown voltage	5	15		V	I _R =100 μA

*Luminous intensity guaranteed to a 2.5% AQL inspection plan per MIL-STD-105D.

TYPICAL THERMAL CHARACTERISTICS

Wavelength temperature coefficient (case temperature) 0.3 nm/°C
 Forward voltage temperature coefficient -2.0 mV/°C

TYPICAL ELECTRO-OPTICAL CHARACTERISTIC CURVES

(25°C Free Air Temperature Unless Otherwise Specified)

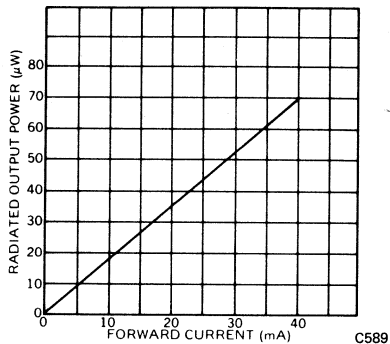


Figure 1 ROP vs. Forward Current

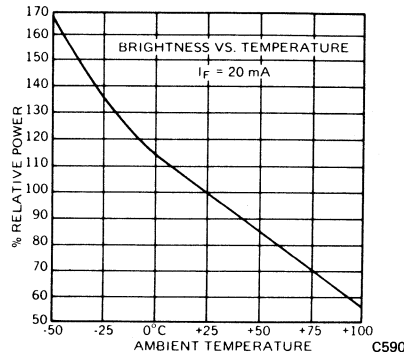


Figure 2 Power vs. Temperature

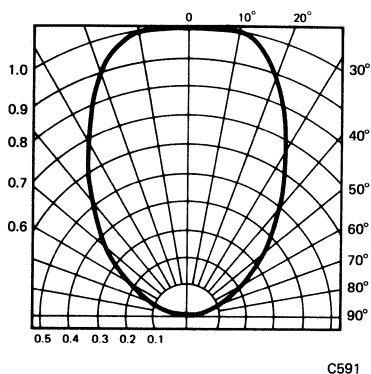


Figure 3 Spatial Distribution (Note 3)

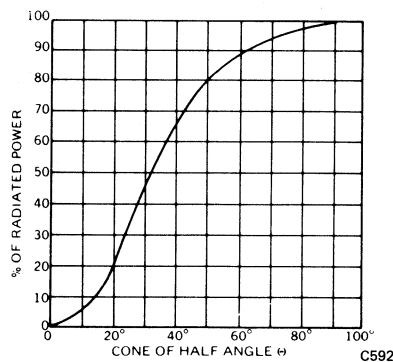


Figure 4 Percent Radiated Power Into Cone of Half Angle

NOTES

1. The leads of the device were immersed in molten solder at 260°C to a point 1/16 inch from the body of the device per MIL-S-750.
2. As measured with a Photo Research Spectra Corp. Microcandela Meter (Model IV D).
3. The axis of spatial distribution are typically within a 10° cone with reference to the central axis of the device.

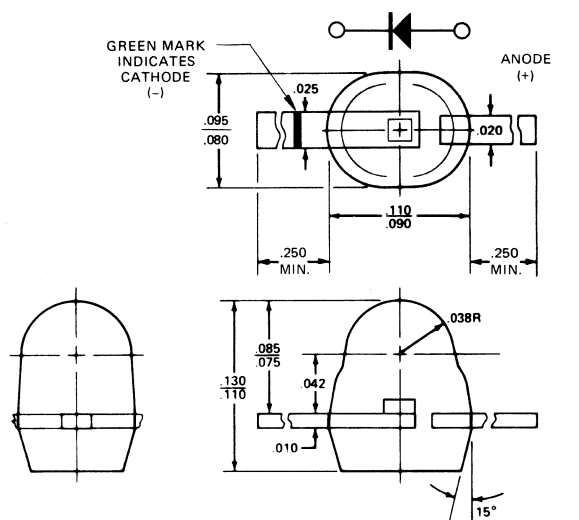
Monsanto

MV55A VISIBLE RED LED

PRODUCT DESCRIPTION:

The MV 55 is a gallium arsenide phosphide device useful for low current drive (3 mA) applications, such as diagnostic functions or indicators.

PACKAGE DIMENSIONS



C593

FEATURES

MV55A is intended as a low cost, high reliability indicator lamp.

- Low cost
- Compatible with integrated circuits.
- Small size
- High on axis intensity.
- 2 Gate Load Bright Light
- MOS compatible

ABSOLUTE MAXIMUM RATINGS

Power dissipation @ 25°C ambient	6 mW
Derate linearly from 25°C	-.08 mW/°C
Storage & operating temperature	-55°C to 100°C
Lead solder time @ 260°C (See Note 1)	5 sec
Continuous forward current	5 mA
Reverse voltage	5.0 V
Peak forward current (1 μsec pulse, 0.1% duty cycle)	400 mA

ELECTRO-OPTICAL CHARACTERISTICS (25°C Free Air Temperature Unless Otherwise Specified)

CHARACTERISTICS	MIN.	TYP.	MAX.	UNITS	TEST CONDITIONS
Brightness (Note 3)*	0.2	0.5		mcd	I _F = 5.0 mA
Peak emission wave length		635		nm	
Spectral line half-width		45		nm	
Forward voltage		1.6	2.0	V	I _F = 3.0 mA
Reverse current		.15	10	μA	V _R = 3.0 volts
Light turn-on and turn-off		1		ns	Z = 1Ω system
Capacitance		20		pF	V = 0
Reverse breakdown voltage 3				V	I _F = 10 μA

* Luminous intensity guaranteed to a 2.5% AQL inspection plan per MIL-STD-105D.

TYPICAL ELECTRO-OPTICAL CHARACTERISTIC CURVES
(25°C Free Air Temperature Unless Otherwise Specified)

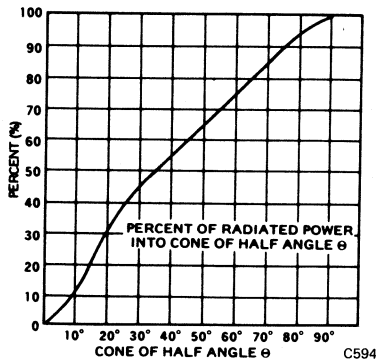


Figure 1

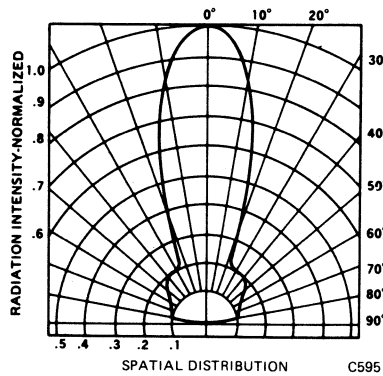


Figure 2 (Note 2)

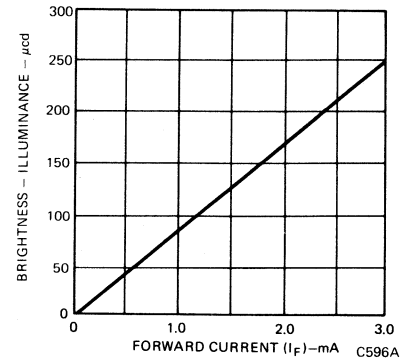


Fig. 3 Brightness vs. Forward Current

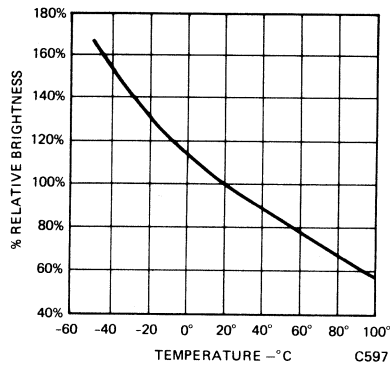


Fig. 4 Relative Output vs. Temperature

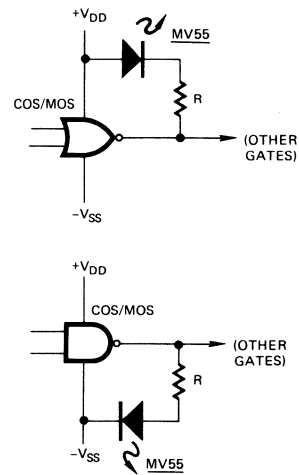


Fig. 5 MV55A Interfaced with COS/MOS

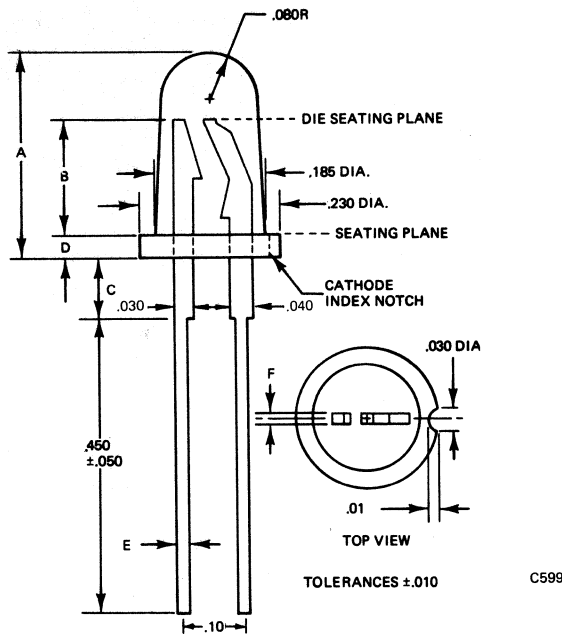
NOTES

1. The leads of the device were immersed in molten solder, heated to a temperature of 260°C, to a point 1/16 inch from the body of the device per MIL-S-750, with dwell time of 5 sec.
2. The axis of spatial distribution are typically within a 10° cone with reference to the central axis of the device.
3. As measured with a Photo Research Spectra Corp. Microcandela Meter (Model IV D).

PRODUCT DESCRIPTION

The MV5020 series of solid state indicators is made with gallium arsenide phosphide light-emitting diodes. Encapsulation and lens is epoxy. Various lens effects are available for many indicator applications.

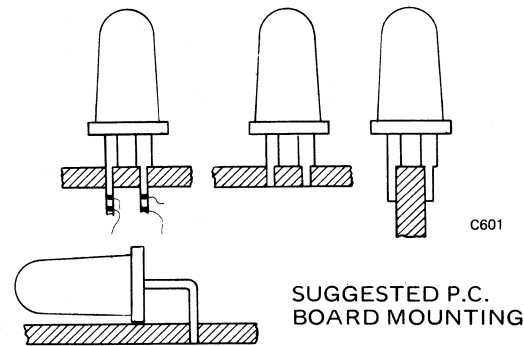
PACKAGE DIMENSIONS



FEATURES

- Low cost
- High intensity red light source with various lens colors and effects
- Versatile mounting on PC board or panel
- Snap in panel mounting clip available (See MP21 and MP22 for clip detail)

BOARD MOUNTING



ABSOLUTE MAXIMUM RATINGS

Power dissipation @ 25°C ambient	180 mW
Derate linearly from 25°C	2 mW/°C
Storage and operating temperatures	-55°C to 100°C
Lead solder time @ 230°C	5 sec
Continuous forward current @ 25°C	100 mA
Continuous forward current @ 100°C	20 mA
Peak forward current (1 μsec pulse, 0.3% duty cycle)	1.0 A
Reverse voltage	5.0 V

PHYSICAL CHARACTERISTICS

TYPE	A	B	C	D	E & F	SOURCE COLOR	LENS COLOR	LENS EFFECT	POP-IN MOUNTING	CIRCUIT BOARD MOUNTING
MV5020	.340	.190	.100	.040	.025	RED	CLEAR	POINT	X	X
MV5021	.340	.190	.100	.040	.025	RED	DIFF.	SOFT	X	X
MV5022	.340	.190	.100	.040	.025	RED	RED	POINT	X	X
MV5023	.340	.190	.100	.040	.025	RED	RED DIFF.	SOFT	X	X
MV5024	.340	.160	.130	.040	.025	RED	RED DIFF.	SOFT FLOODED	X	X
MV5025	.340	.160	.130	.040	.025	RED	RED DIFF.	FLOODED	X	X
MV5026	.340	.160	.130	.040	.025	RED	RED DIFF.	FLOODED	X	X

ELECTRO-OPTICAL CHARACTERISTICS

PARAMETER	TEST COND.	UNITS	5020	5021	5022	5023	5024	5025	5026
Luminous Intensity (Min.) (Note 2)*	20 mA	mcd	0.6	0.5	0.6	0.4	0.9	0.1	0.1
Luminous Intensity I (Typ.) (Note 2)	20 mA	mcd	2.0	1.6	1.6	1.6	3.0	.4	.6
Peak Wave Length +30 -20	20 mA	nm	660	660	660	660	660	660	660
Spectral Line Half Width	20 mA	nm	20	20	20	20	20	20	20
Forward Voltage Typ.	20 mA	V	1.65	1.65	1.65	1.65	1.65	1.65	1.65
VF Max.	20 mA	V	2.0	2.0	2.0	2.0	2.0	2.0	2.0
Reverse Current IR Typ.	$V_R = 5.0 V$	nA	15	15	15	15	15	15	15
Max.	$V_R = 5.0 V$	μA	100	100	100	100	100	100	100
Reverse Voltage VR Min.	$I_R = 100\mu A$	V	5.0	5.0	5.0	5.0	5.0	5.0	5.0
Typ.	$I_R = 100\mu A$	V	10.0	10.0	10.0	10.0	10.0	10.0	10.0
Capacitance Typ.	$V = 0$	pF	35	35	35	35	35	35	35
View Angle	Between 50% Points	Degrees	90	90	90	90	60	180	90
Light Rise Time & Fall Time Typ.	10%-90% 50 Ω system	nsec	50	50	50	50	50	50	50
	90%-10% 50 Ω system	nsec	50	50	50	50	50	50	50
Apparent Area (Circular)		cm ² (x10 ⁻³)	.828	32.5	.828	32.5	130	130	130

*Luminous intensity guaranteed to a 2.5% AQL inspection plan per MIL-STD-105D.

TYPICAL ELECTRO-OPTICAL CHARACTERISTICS

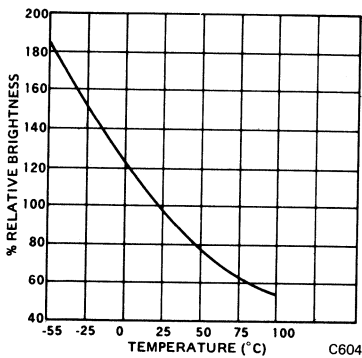


Fig. 1. Brightness vs. Temperature

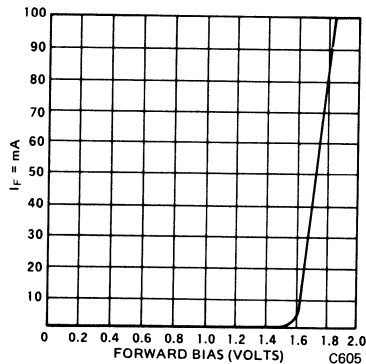


Fig. 2. Forward Current vs. Forward Voltage

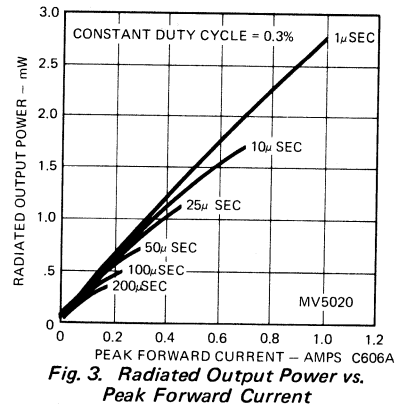


Fig. 3. Radiated Output Power vs. Peak Forward Current

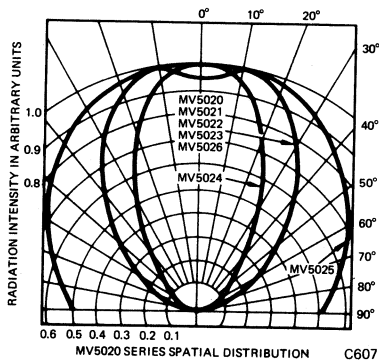


Fig. 4. Spatial Distribution

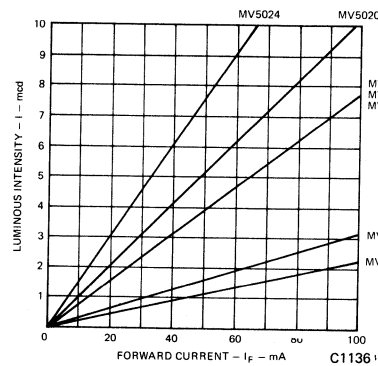


Fig. 5. Luminous Intensity vs. Forward Current

NOTES

- As measured with a Photo Research Spectra Brightness Spot Meter with "SPECTAR" L-175 lens in the center of the emitting surface.
- As measured with a Photo Research Spectra Corp. Microcandela Meter (Model IV D).
- The axis of spatial distribution are typically within a 10° cone with reference to the central axis of the device.

Monsanto

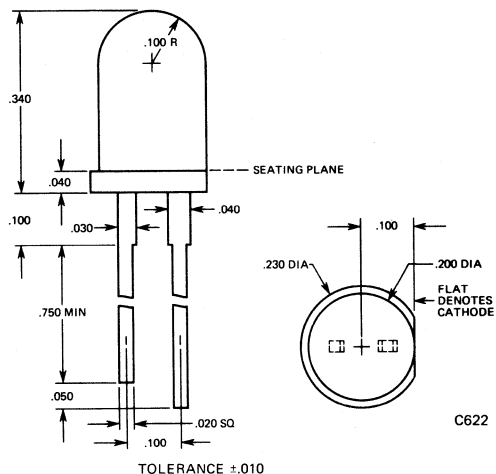
RED SOLID STATE LAMPS

MV5054-1 MV5054-2 MV5054-3

PRODUCT DESCRIPTION

The MV5054 series lamps are made with gallium arsenide phosphide diodes mounted in a red epoxy package.

PACKAGE DIMENSIONS



FEATURES

- GaP performance
- Illuminates a $\frac{1}{4}$ " dia circle
- Low cost
- High intensity red light source for back lighting a panel
- Versatile mounting on PC board
- Transparent mounting clip available
- Three intensity categories

ABSOLUTE MAXIMUM RATINGS

Power dissipation @ 25°C ambient	180 mW
Derate linearly from 25°C	2.0 mW/°C
Storage and operating temperatures	-55°C to 100°C
Lead solder time @ 230°C (See Note 3) e Note 3)	5 sec
Continuous forward current @ 25°C	100 mA
Continuous forward current @ 100°C	15 mA
Peak forward current (1 μ sec pulse, 0.3% duty cycle)	1.0 A
Reverse Voltage	5.0 V
Reverse current	10 μ A

ELECTRO-OPTICAL CHARACTERISTICS

(25°C Ambient Temperature Unless Otherwise Specified)

CHARACTERISTICS	MIN.	TYP.	MAX.	UNITS	TEST CONDITIONS
Luminous intensity (note 1)					
MV5054-1	1.0	2.0		mcd	$I_F = 10$ mA
MV5054-2	2.0	3.0		mcd	$I_F = 10$ mA
MV5054-3	3.0	4.0		mcd	$I_F = 10$ mA
Forward voltage		1.8	2.2	V	$I_F = 10$ mA
Capacitance		35		pF	$V = 0$
Reverse current			100	μ A	$V_R = 5.0$ V
Rise and fall time		50		nS	50 Ω System
Viewing angle (total)		40		degrees	Between 50% intensity points
Apparent area		.203		cm ²	

TYPICAL ELECTRO-OPTICAL CHARACTERISTIC CURVES

(25°C Free Air Temperature Unless Otherwise Specified)

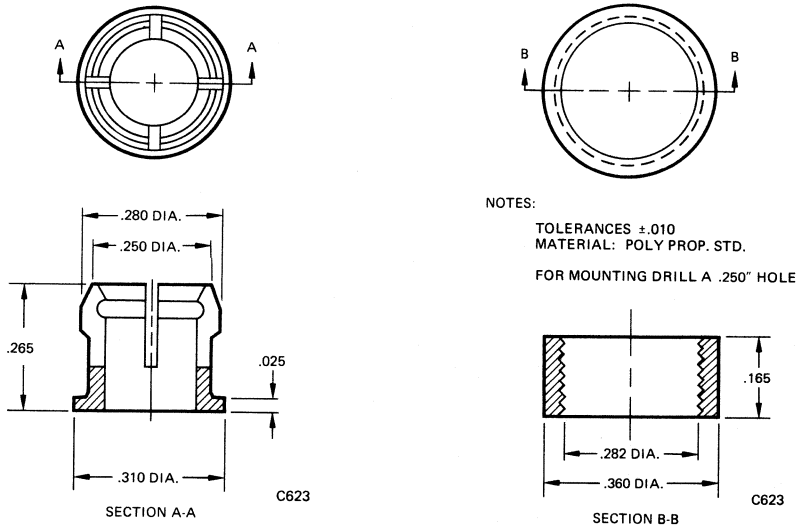


Fig. 1. Mounting Grommet (supplied only on request)

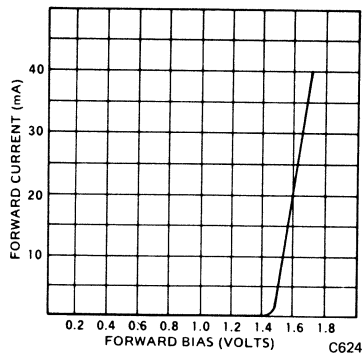


Fig. 2. Forward Current vs. Forward Voltage

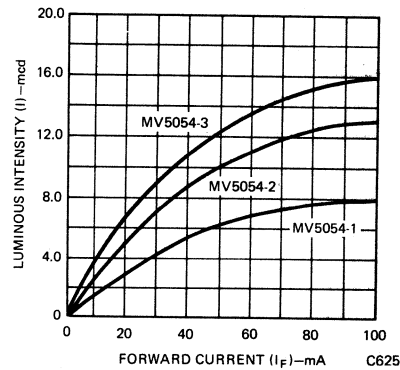


Fig. 3. Luminous Intensity vs. Forward Current

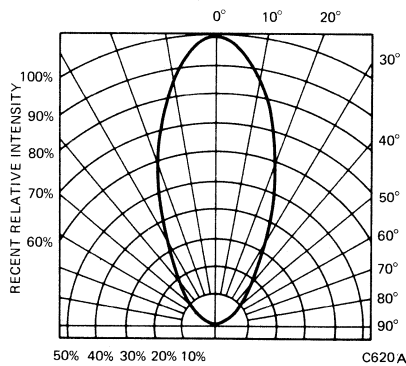


Fig. 4. Spatial Distribution (Note 2)

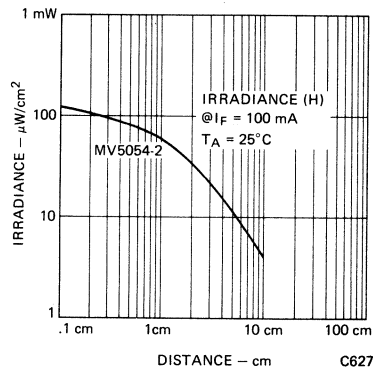


Fig. 5. Irradiance vs. Distance

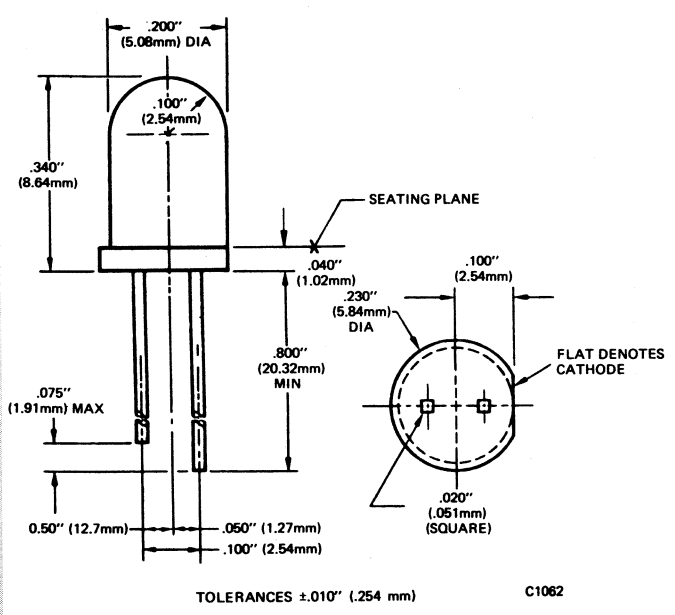
NOTES

1. As measured with a Photo Research Corp. "SPECTRA" Microcandela Meter (Model IV D).
2. The axis of spatial distribution are typically within a 10° cone with reference to the central axis of the device.
3. The leads of the device were immersed in molton solder, at 260°C, to a point 1/16 inch from the body of the device per MIL-S-750.

PRODUCT DESCRIPTION

The MV5050 series of solid state indicators is made with Gallium Arsenide Phosphide light emitting diodes encapsulated in epoxy lenses. Various lens effects are pleasing in different design settings.

PACKAGE DIMENSIONS



FEATURES

- Low cost
- High intensity red light source with various lens colors and effects
- Versatile mounting on P.C. board or panel
- Snap in clip available on request
- Long life—solid state reliability
- Low power requirements
- Compacts, rugged, lightweight
- High efficiency
- Ultra high brightness

PHYSICAL CHARACTERISTICS

TYPE	SOURCE COLOR	LENS COLOR	LENS EFFECT	POP-IN MOUNTING	CIRCUIT BOARD MOUNTING
MV5050	Red	Clear	Point	X	X
MV5051	Red	Diffused	Soft	X	X
MV5052	Red	Red	Point	X	X
MV5053	Red	Red Diffused	Flooded	X	X
MV5055	Red	Red Diffused	Flooded	X	X
MV5056	Red	Red Diffused	Flooded	X	X

ELECTRO-OPTICAL CHARACTERISTICS

PARAMETER	TEST COND.	UNITS	5050	5051	5052	5053	5055	5056
Forward Voltage (V_F)								
Typ.	$I_F = 20 \text{ mA}$	V	1.7	1.7	1.7	1.7	1.7	1.7
Max.	$I_F = 20 \text{ mA}$	V	2.2	2.2	2.2	2.2	2.2	2.2
Luminous Intensity*								
(See note 1)								
Typ.	$I_F = 20 \text{ mA}$	mcd	2.0	1.6	2.0	1.6	.6	.8
Min.	$I_F = 20 \text{ mA}$	mcd	0.5	0.4	0.7	0.5	0.1	0.2
Peak Wave Length	$I_F = 20 \text{ mA}$	nm	670	670	670	670	670	670
Spectral Line Half Width	$I_F = 20 \text{ mA}$	nm	20	20	20	20	20	20
Capacitance								
Typ.	$V = 0$	pF	30	30	30	30	30	30
Reverse Voltage (V_R)								
Min.	$I_R = 100\mu\text{A}$	V	5	5	5	5	5	5
Typ.	$I_R = 100\mu\text{A}$	V	25	25	25	25	25	25
Reverse Current (I_R)								
Max.	$V_R = 5.0\text{V}$	μA	100	100	100	100	100	100
Typ.	$V_R = 5.0\text{V}$	nA	20	15	5	5	5	5
Light Rise Time	10%-90%	nsec	50	50	50	50	50	50
	50 Ω system							
Light Fall Time	90%-10%	nsec	50	50	50	50	50	50
	50 Ω system							
Viewing Angle	See Fig. 5 & 6	degrees	50	72	72	80	150	110

*Luminous intensity guaranteed to a 2.5% AQL inspection plan per MIL-STD-105D.

ABSOLUTE MAXIMUM RATINGS

Power dissipation @ 25°C ambient	180 mW
Derate linearly from 25°C	2.0 mW/°C
Storage and operating temperatures	-55°C to 100°C
Lead solder time @ 230°C (See Note 3)	5 sec
Continuous forward current @ 25°C	100 mA
Continuous forward current @ 100°C	15 mA
Peak forward current (1 μsec pulse, 0.3% duty cycle)	1.0 A
Reverse voltage	5.0 V

TYPICAL ELECTRO-OPTICAL CHARACTERISTIC CURVES

(25°C Free Air Temperature Unless Otherwise Specified)

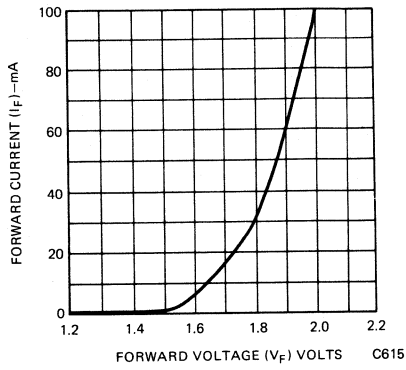


Fig. 1. Forward Current vs. Forward Voltage

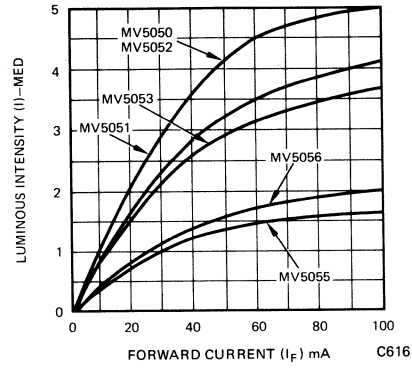


Fig. 2. Luminous Intensity vs. Forward Current

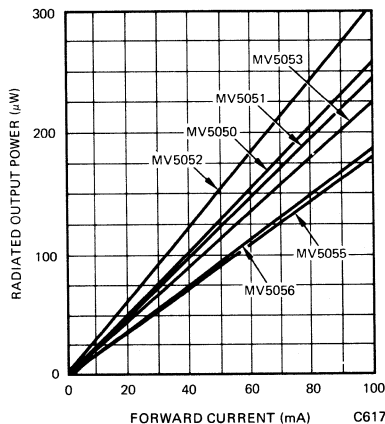


Fig. 3. ROP vs. Forward Current

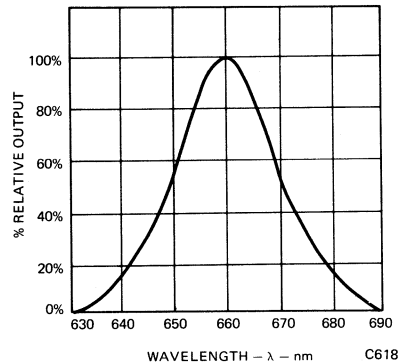


Fig. 4. Spectral Response

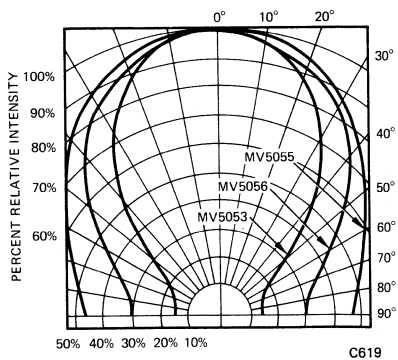


Fig. 5. Spatial Distribution (Note 2)
(MV5053, MV5055, MV5056)

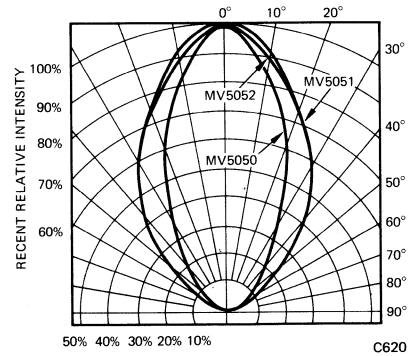


Fig. 6. Spatial Distribution (Note 2)
(MV5050, MV5051, MV5052)

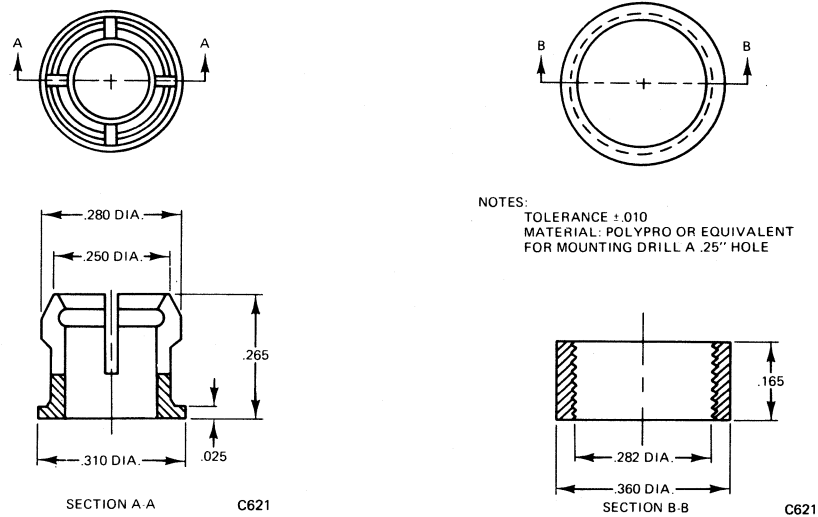


Fig. 7. Mounting Grommet (supplied on request only)

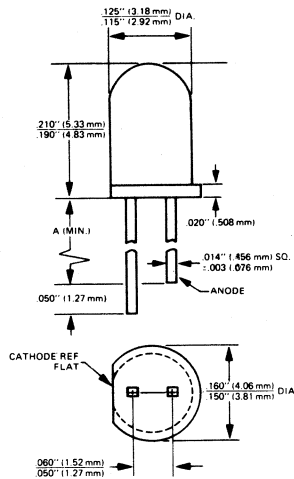
NOTES

1. As measured with a Photo Research Corp. "SPECTRA" Microcandela Meter (Model IV D).
2. The axes of spatial distribution are typically within a 10° cone with reference to the central axis of the device.
3. The leads of the device were immersed in molten solder, at 260°C , to a point $1/16$ inch from the body of the device per MIL-S-750.

PRODUCT DESCRIPTION

The MV5074B/C and MV5075B/C are red (GaAsP) light emitting diodes mounted in a red epoxy package. Their small size (approximately T-1 size), good viewing angle, and small square leads contribute to their versatility as all purpose indicators.

PACKAGE DIMENSIONS



LEAD LENGTH (A)	
MV5074B	.60" (15.2 mm)
MV5075B	.60" (15.2 mm)
MV5074C	1.00" (25.4 mm)
MV5075C	1.00" (25.4 mm)

FEATURES

- Square leads (will fit into .020" (.508 mm) diameter hole)
- Compact size
- Bright (typically 2.0 mcd at 20 mA)
- Long life, rugged
- MV5074B and MV5075B have .6" (15.2 mm) minimum lead length
- MV5074C and MV5075C have 1" (25.4 mm) minimum lead length
- Mount on approximately 3/16" (4.72 mm) centers
- Direct replacement for Texas Instruments TIL-209A (MV5074B)

ABSOLUTE MAXIMUM RATINGS

Power Dissipation @ 25°C	100 mW
Derate Linearly from 25°C	-1.27 mW/°C
Storage Temperature	-55°C to +100°C
Operating Temperature	-55°C to +100°C
Continuous Forward Current (25°C)	50 mA
Peak Forward Current (1 μsec Pulse Width, 0.3% Duty Cycle)	1.0 A
Reverse Voltage	5.0 Volts
Lead Solder Time (230°C, 1/16" from body)	5 sec

TYPICAL ELECTRO-OPTICAL CHARACTERISTICS

CHARACTERISTICS	MIN.	TYP.	MAX.	UNITS	TEST CONDITIONS
Optical					
Luminous Intensity (I) (Note 1)*					
MV5074B/C	0.7	2.5		mcd	I _F = 20 mA
MV5075B/C	0.6	1.6		mcd	I _F = 20 mA
Wavelength (λ _p)	640	660	700	nm	
Spectral Half Width		20		nm	
Viewing Angle					
MV5074B/C		70		degrees	Between 50% points
MV5075B/C		90		degrees	Between 50% points
Radiated Output Power (ROP)		30		μW	I _F = 20 mA
Electrical					
Forward Voltage (V _F)		1.68	2.0	Volts	I _F = 20 mA
Reverse Voltage (V _R)	5.0	15.0		Volts	I _R = 100 μA
Dynamic Resistance (R _D)		7.0		Ω	
Capacitance		23		pF	V = 0

*Luminous intensity guaranteed to a 2.5% AQL inspection plan per MIL-STD-105D.

TYPICAL ELECTRO-OPTICAL CHARACTERISTIC CURVES

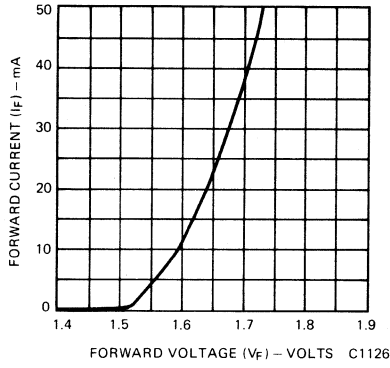


Fig. 1. Forward Current vs. Forward Voltage

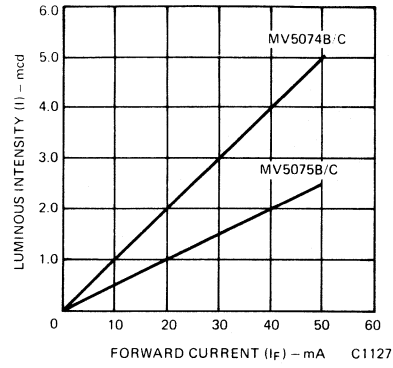


Fig. 2. Luminous Intensity vs. Forward Current

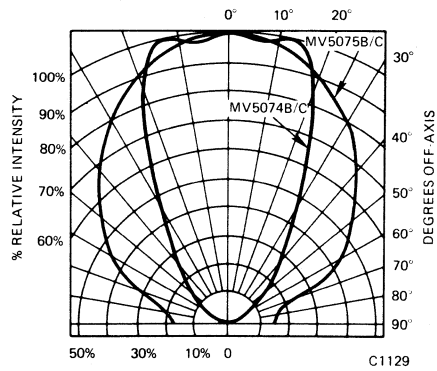


Fig. 3. Spatial Distribution

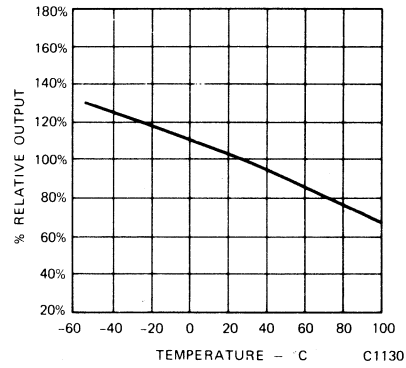


Fig. 4. Percent Relative Response vs. Temperature

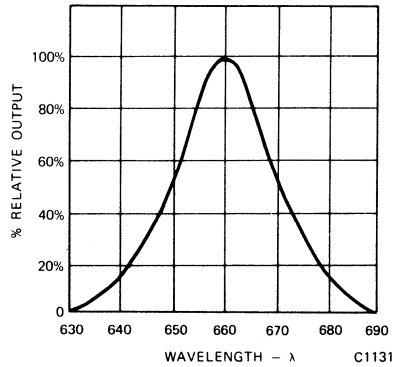


Fig. 5. Spectral Response

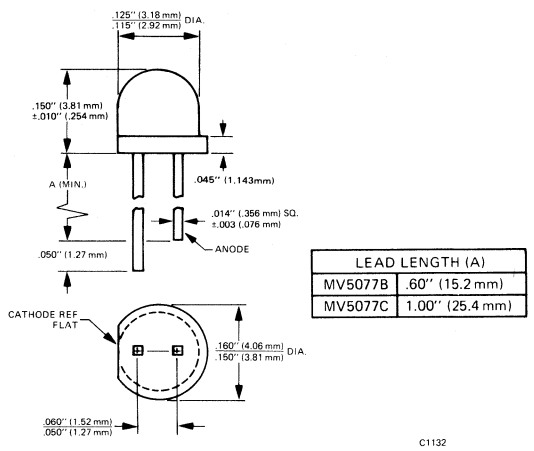
NOTES

1. Luminous Intensity measurements are taken with a Photo Research Corp., "SPECTRA" Microcandela Meter (Model IV D).

PRODUCT DESCRIPTION

The MV5077B and MV5077C are red (GaAsP) light emitting diodes mounted in a red epoxy package. Their small size (approximately T-1 size), good viewing angle, and small square leads contribute to their versatility as all purpose indicators.

PACKAGE DIMENSIONS



FEATURES

- Square leads (will fit into .020" (.508 mm) diameter hole)
- Compact size
- Bright (typically 1.75 mcd at 20 mA)
- Long life, rugged
- MV5077B have .6" (15.2 mm) minimum lead length
- MV5077C have 1" (25.4 mm) minimum lead length
- Mount on approximately 3/16" (4.72 mm) centers

ABSOLUTE MAXIMUM RATINGS

Power Dissipation @ 25°C	100 mW
Derate Linearly from 25°C	1.27 mW/°C
Storage Temperature	-55°C to +100°C
Operating Temperature	-55°C to +100°C
Continuous Forward Current (25°C)	50 mA
Peak Forward Current (1 μsec Pulse Width, 0.3% Duty Cycle)	1.0 A
Reverse Voltage	5.0 Volts
Lead Solder Time (230°C, 1/16" from body)	5 sec

TYPICAL ELECTRO-OPTICAL CHARACTERISTICS

CHARACTERISTICS	MIN.	TYP.	MAX.	UNITS	TEST CONDITIONS
Optical					
Luminous Intensity (I) (Note 1)*	0.3	1.75		mcd	I _F = 20 mA
Wavelength (λ _{pk})	640	660	700	nm	I _F = 20 mA
Spectral Half Width		20		nm	I _F = 20 mA
Viewing Angle		110		degrees	Between 50% points
Radiated Output Power (ROP)		30		μW	I _F = 20 mA
Electrical					
Forward Voltage (V _F)		1.68	2.0	Volts	I _F = 20 mA
Reverse Voltage (V _R)	5.0	15.0		Volts	I _R = 100 μA
Dynamic Resistance (R _D)		7.0		Ω	
Capacitance		23		pF	V = 0

*Luminous intensity guaranteed to a 2.5% AQL inspection plan per MIL-STD-105D.

TYPICAL ELECTRO-OPTICAL CHARACTERISTIC CURVES

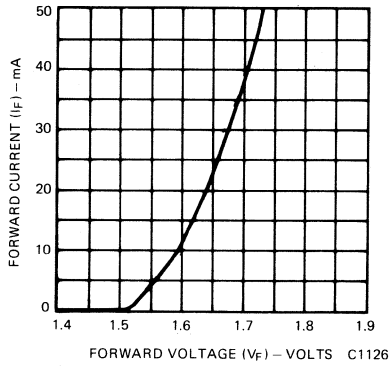


Fig. 1. Forward Current vs. Forward Voltage

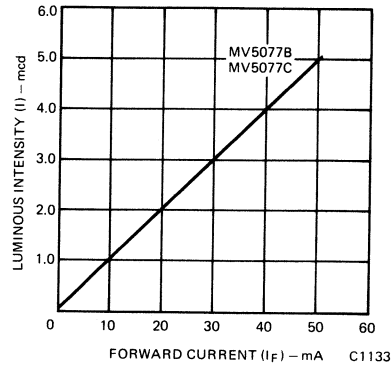


Fig. 2. Luminous Intensity vs. Forward Current

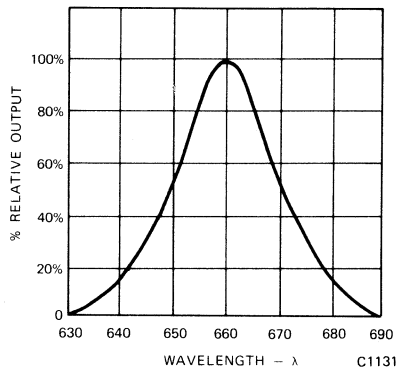


Fig. 3. Spectral Response

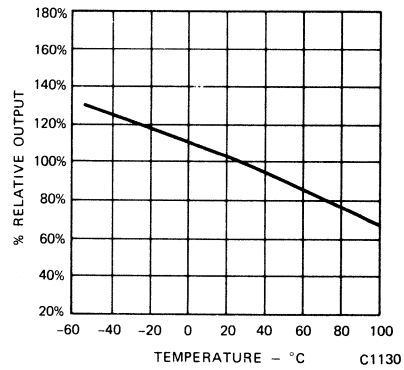


Fig. 4. Percent Relative Response vs. Temperature

NOTES

1. Luminous Intensity measurements are taken with a Photo Research Corp., "SPECTRA" Microcandela Meter (Model IV D).

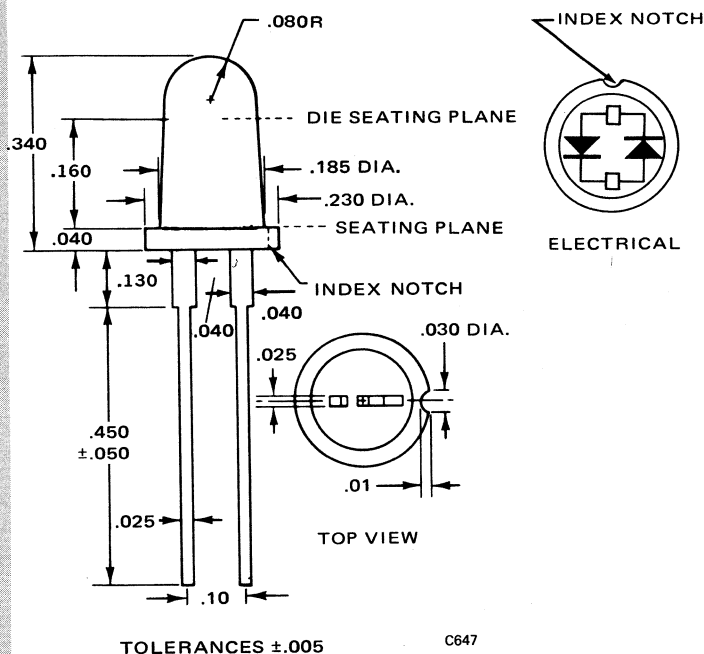
Monsanto

MV5094 RED BIPOLAR SOLID STATE LAMP

PRODUCT DESCRIPTION

The MV5094 is the first commercially available solid state AC-DC lamp. Reliability, long life, plus a convenient panel mounting enable this red lamp to be run from A.C. voltages even as high as 110-115 V.

PACKAGE DIMENSIONS



FEATURES

- Bright
- Solid state
- A.C. lamp
- 110-115 VAC operation (see chart)
- Versatile mounting on P.C. board or panel
- Convenient mounting clip available
- Cool operation—no hot bulb
- Long life
- This lamp mounts in the MP21 or MP22 grommet.

ABSOLUTE MAXIMUM RATINGS

Power Dissipation @ 25°C (Peak or continuous)	140 mW
Storage Temperature	-65°C to +125°C
Operating Temperature	-55°C to +100°C
A.C.(RMS)/D.C. Forward Current 25°C	70 mA
A.C.(RMS)/D.C. Forward Current 100°C	5 mA
I ² T (0.1% Duty Cycle)	2.5 x 10 ⁻⁴ amps ² sec
I _{peak} (repetitive) (0.3% Duty Cycle, 1.0 μsec pulse width)	1.0A
Lead Solder time 230°C	5 sec

TYPICAL ELECTRO-OPTICAL CHARACTERISTICS (25°C Ambient Temperature Unless Stated Otherwise)

	MIN.	TYP.	MAX.	UNITS	CONDITIONS
Luminous Intensity (I) (note 1)		.8		mcd	I _f = 20 mA
Forward Voltage (V _f)		1.6	2.0	volts	I _f = 20 mA

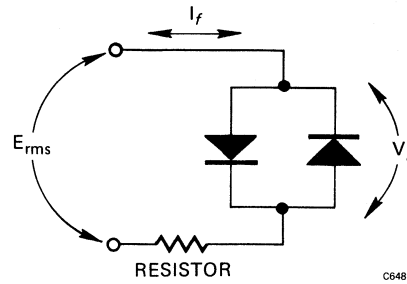
AC OPERATION

E_{RMS}	$I_f = 10 \text{ mA}, V_f = 1.56$ RESISTOR	$I_f = 25 \text{ mA}, V_f = 1.62$ RESISTOR	$I_f = 50 \text{ mA}, V_f = 1.66$ RESISTOR	$I_f = 70 \text{ mA}, V_f = 1.70$ RESISTOR
5.0	360 Ω , 1/8 W	130 Ω , 1/8 W	68 Ω , 1/4 W	51 Ω , 1/4 W
6.3	470 Ω , 1/8 W	180 Ω , 1/8 W	100 Ω , 1/4 W	68 Ω , 1/2 W
9.0	750 Ω , 1/8 W	300 Ω , 1/4 W	150 Ω , 1/2 W	110 Ω , 1 W
12.0	1.0 K Ω , 1/8 W	430 Ω , 1/2 W	200 Ω , 1/2 W	150 Ω , 1 W
15.0	1.3 K Ω , 1/4 W	560 Ω , 1/2 W	270 Ω , 1 W	200 Ω , 1 W
18.0	1.6 K Ω , 1/4 W	680 Ω , 1/2 W	330 Ω , 1 W	240 Ω , 2 W
24.0	2.2 K Ω , 1/4 W	910 Ω , 1 W	470 Ω , 2 W	330 Ω , 2 W
28.0	2.7 K Ω , 1/2 W	1.1 K Ω , 1 W	560 Ω , 2 W	390 Ω , 2 W
48.0	4.7 K Ω , 1/2 W	1.8 K Ω , 2 W	-----	-----
110.0	11.0 K Ω , 2 W	-----	-----	-----

Resistor values are nearest commercially available.

$$\text{Resistor Value} = \frac{E_{(RMS)} - V_f}{I_f}$$

where: I_f corresponds to a desired brightness level (from fig. 2).
 V_f corresponds to the voltage across the device (from fig. 1).



C648

TYPICAL ELECTRO-OPTICAL CHARACTERISTICS

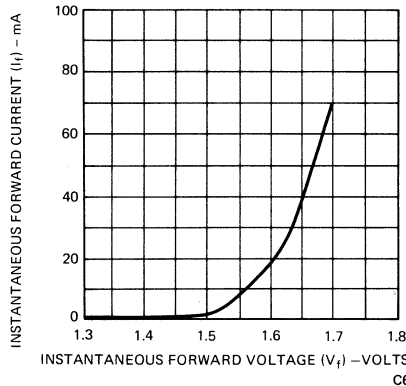


Fig. 1. Forward Current vs. Forward Voltage

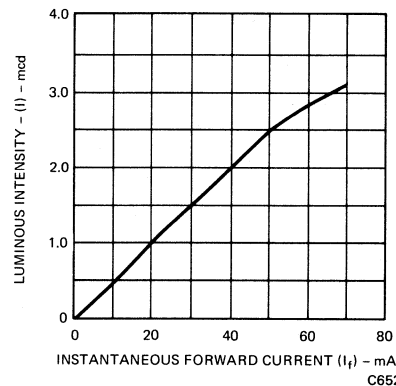


Fig. 2. Luminous Intensity vs. Forward Current

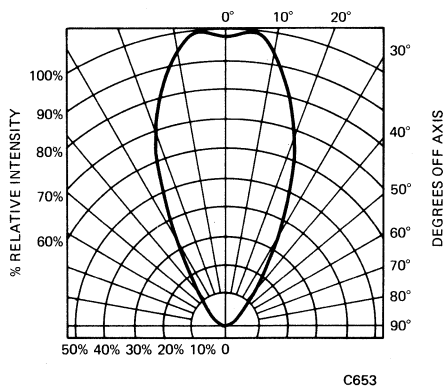


Fig. 3. Spatial Distribution

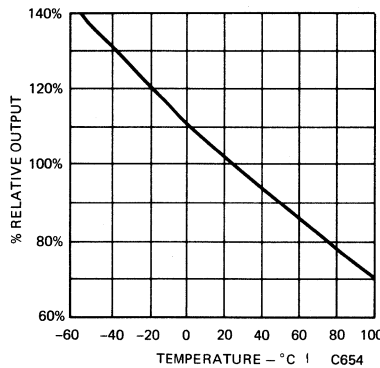


Fig. 4. Output vs. Temperature

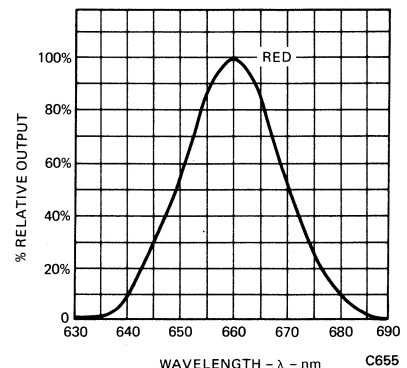


Fig. 5. Spectral Distribution

NOTES:

1. Luminous Intensity figures are the typical values per phase of operation and measured with a Photo Research Corp. Microcandela Meter (Model IV D).
2. Values of Luminous Intensity may begin to decrease for operation above 25 KHz.

Monsanto

SOLID STATE LAMPS

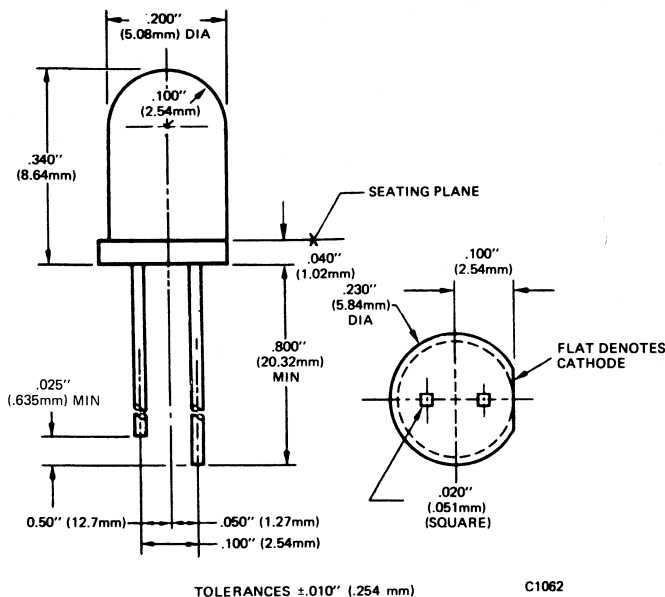
ORANGE
GREEN
YELLOW
IMPROVED RED

MV5152
MV5252
MV5352
MV5752

PRODUCT DESCRIPTION

These solid state indicators offer high brightness and color availability. The orange, red, and yellow devices are made with gallium arsenide phosphide, and the green units are made with gallium phosphide. All are encapsulated in epoxy lenses.

PACKAGE DIMENSIONS



FEATURES

- Low cost
- Ultra high intensity light sources
- Orange, green, yellow, and red colors available. (See MV5050 series for other red sources.)
- Versatile mounting on P.C. board or panel
- Snap in clip available on request
- Long life—solid state reliability
- Low power requirements
- Compact, rugged, lightweight
- High efficiency

ABSOLUTE MAXIMUM RATINGS

Power dissipation @ 25°C ambient	105 mW
Derate linearly from 25°C	1.14 mW/°C
Storage temperature	-55°C to 100°C
Operating temperature	-55°C to 100°C
Lead solder time @ 230°C (see Note 2)	5 sec
Continuous forward current @ 25°C	35 mA
Continuous forward current @ 100°C	10 mA
Peak forward current (1 μsec pulse, 0.3% duty cycle)	1.0 A
Reverse voltage	5.0 V

PHYSICAL CHARACTERISTICS

TYPE	SOURCE COLOR	LENS COLOR	LENS EFFECT	POP-IN MOUNTING	CIRCUIT BOARD MOUNTING
MV5152	Orange	Clear orange	Narrow beam; point source	X	X
MV5252	Green	Clear green	Narrow beam; point source	X	X
MV5352	Yellow	Clear yellow	Narrow beam; point source	X	X
MV5752	Orange	Clear red	Narrow beam; point source	X	X

ELECTRO-OPTICAL CHARACTERISTICS

PARAMETER	TEST COND.	UNITS	MV5152	MV5252	MV5352	MV5752
Forward voltage (V_F)						
Typ.	$I_F = 20 \text{ mA}$	V	2.0	2.2	2.1	2.0
Max.	$I_F = 20 \text{ mA}$	V	3.0	3.0	3.0	3.0
Luminous intensity (see Note 1)*						
Min.	$I_F = 20 \text{ mA}$	mcd	17.0	2.0	10.0	17.0
Typ.	$I_F = 20 \text{ mA}$	mcd	40.0	15.0	45.0	40.0
Peak wave length	20 mA	nm	635	565	585	635
Spectral line	20 mA	nm	45	35	35	45
Half width						
Capacitance						
Typ.	$V = 0$	pF	45	45	45	45
Reverse voltage (V_R)						
Min.	$I_R = 100 \mu\text{A}$	V	5	5	5	5
Typ.	$I_R = 100 \mu\text{A}$	V	25	25	25	25
Reverse current (I_R)						
Max.	$V_R = 5.0 \text{ V}$	μA	100	100	100	100
Typ.	$V_R = 5.0 \text{ V}$	nA	20	20	20	20
Viewing angle (total)	See Fig. 3 & 4	degrees	28	28	28	28

*Luminous intensity guaranteed to a 2.5% AQL inspection plan per MIL-STD-105D.

TYPICAL ELECTRO-OPTICAL CHARACTERISTIC CURVES
(25°C Free Air Temperature Unless Otherwise Specified)

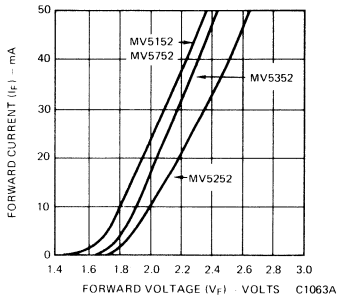


Fig. 1. Forward Current vs. Forward Voltage

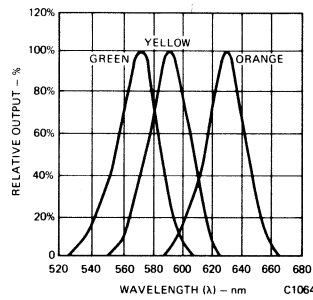


Fig. 2. Spectral Response

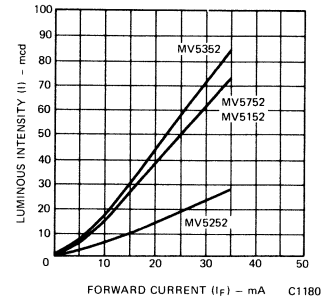


Fig. 3. Brightness vs. Forward Current

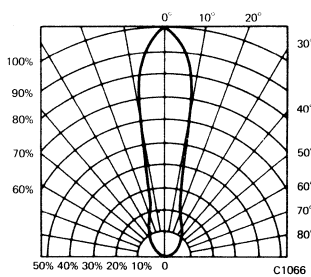


Fig. 4. Spatial Distribution (Note 2)
(MV5352, MV5252, MV5152, MV5752)

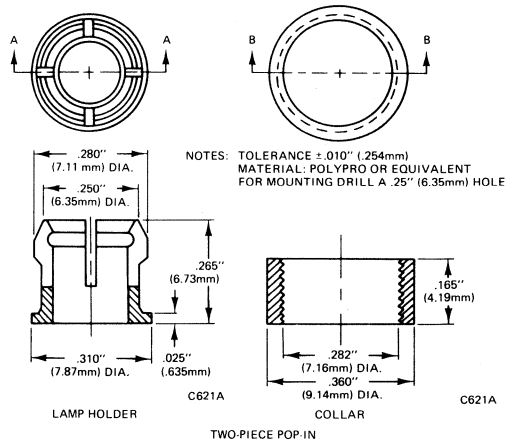


Fig. 5. Mounting Grommet
(supplied on request only)

NOTES

- As measured with a Photo Research Corp. "SPECTRA" Microcandela Meter (Model IV D).
- The axes of spatial distribution are typically within a 10° cone with reference to the central axis of the device.
- The leads of the device were immersed in molten solder, at 230°C, to a point 1/16 inch from the body of the device per MIL-S-750.

Monsanto

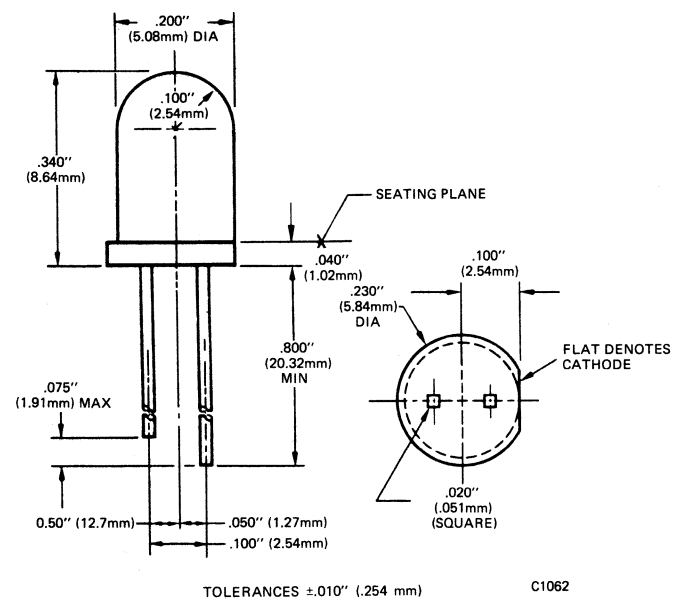
SOLID STATE LAMPS

ORANGE MV5153 MV5154
 GREEN MV5253 MV5254
 YELLOW MV5353 MV5354

PRODUCT DESCRIPTION

These solid state indicators offer a variety of lens effects and color availability. The orange and yellow devices are made with gallium arsenide phosphide, and the green units are made with gallium phosphide. All are encapsulated in epoxy lenses.

PACKAGE DIMENSIONS



FEATURES

- Low cost
- High intensity light source with various lens effects.
- Orange, green, and yellow colors available. (See MV5050 series for red sources.)
- Versatile mounting on P.C. board or panel
- Snap in clip available on request
- Long life—solid state reliability
- Low power requirements
- Compact, rugged, lightweight
- High efficiency
- Ultra high brightness

ABSOLUTE MAXIMUM RATINGS

Power dissipation @ 25°C ambient	105 mW
Derate linearly from 25°C	1.14 mW/°C
Storage and operating temperatures	-55°C to 100°C
Lead solder time @ 230°C (see Note 3)	5 sec
Continuous forward current @ 25°C	35 mA
Continuous forward current @ 100°C	10 mA
Peak forward current (1 μsec pulse, 0.3% duty cycle)	1.0 A
Reverse voltage	5.0 V

PHYSICAL CHARACTERISTICS

TYPE	SOURCE COLOR	LENS COLOR	LENS EFFECT	POP-IN MOUNTING	CIRCUIT BOARD MOUNTING
MV5153	Orange	Orange diffused	Wide beam	X	X
MV5154	Orange	Orange diffused	Narrow beam	X	X
MV5253	Green	Green diffused	Wide beam	X	X
MV5254	Green	Green diffused	Narrow beam	X	X
MV5353	Yellow	Yellow diffused	Wide beam	X	X
MV5354	Yellow	Yellow diffused	Narrow beam	X	X

ELECTRO-OPTICAL CHARACTERISTICS

PARAMETER	TEST COND.	UNITS	MV5153	MV5154	MV5253	MV5254	MV5353	MV5354
Forward voltage (V_F)								
Typ.	$I_F = 20 \text{ mA}$	V	2.0	2.0	2.2	2.2	2.1	2.1
Max.	$I_F = 20 \text{ mA}$	V	3.0	3.0	3.0	3.0	3.0	3.0
Luminous intensity (see Note 1)*								
Min.	$I_F = 20 \text{ mA}$	mcd	3.0	3.0	0.8	0.9	2.5	3.0
Typ.	$I_F = 20 \text{ mA}$	mcd	6.0	8.0	1.5	3.0	6.0	10.0
Peak wave length	$I_F = 20 \text{ mA}$	nm	635	635	565	565	585	585
Spectral line	$I_F = 20 \text{ mA}$	nm	45	45	35	35	35	35
Half width								
Capacitance								
Typ.	$V = 0$	pF	45	45	45	45	45	45
Reverse voltage (V_R)								
Min.	$I_R = 100 \mu\text{A}$	V	5	5	5	5	5	5
Typ.	$I_R = 100 \mu\text{A}$	V	25	25	25	25	25	25
Reverse current (I_R)								
Max.	$V_R = 5.0 \text{ V}$	μA	100	100	100	100	100	100
Typ.	$V_R = 5.0 \text{ V}$	nA	20	20	20	20	20	20
Viewing angle (total)	See Fig. 3 & 4	degrees	65	24	65	24	65	24

*Luminous intensity guaranteed to a 2.5% AQL inspection plan per MIL-STD-105D.

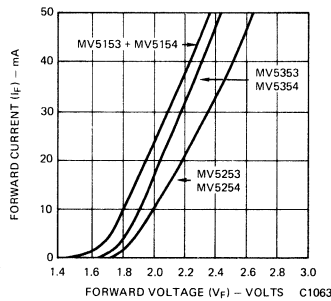
TYPICAL ELECTRO-OPTICAL CHARACTERISTIC CURVES

Fig. 1. Forward Current vs. Forward Voltage

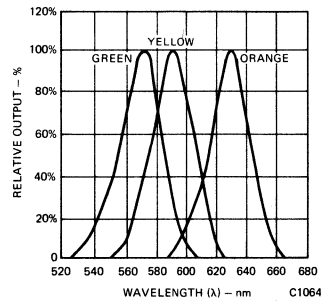


Fig. 2. Spectral Response

(25°C Free Air Temperature Unless Otherwise Specified)

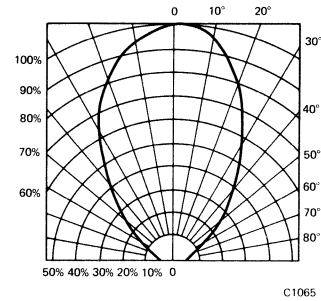


Fig. 3. Spatial Distribution (Note 2) (MV5353, MV5253, MV5153)

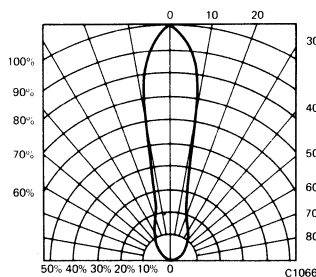


Fig. 4. Spatial Distribution (Note 2) (MV5354, MV5254, MV5154)

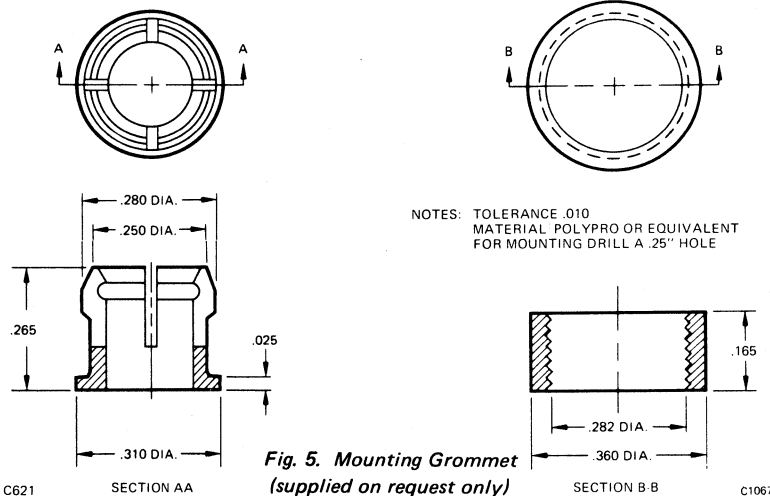


Fig. 5. Mounting Grommet (supplied on request only)

NOTES

- As measured with a Photo Research Corp. "SPECTRA" Microcandela Meter (Model IV D).
- The axes of spatial distribution are typically within a 10° cone with reference to the central axis of the device.
- The leads of the device were immersed in molten solder, at 230°C, to a point 1/16 inch from the body of the device per MIL-S-750.

Monsanto

SOLID STATE LAMPS

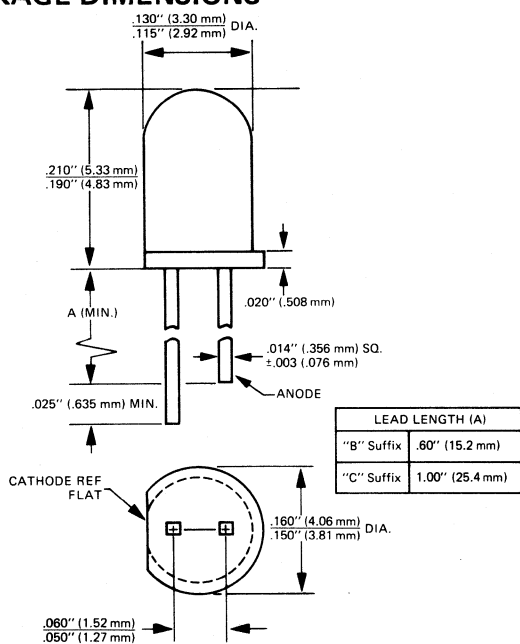
ORANGE
GREEN
YELLOW
IMPROVED RED

MV5174B/C
MV5274B/C
MV5374B/C
MV5774B/C

PRODUCT DESCRIPTION

These solid state indicators offer a variety of color selection. The orange, red, and yellow devices are made with gallium arsenide phosphide, and the green units are made with gallium phosphide. All are encapsulated in epoxy packages. Their small size (approximately T-1 size), good viewing angle, and small square leads contribute to their versatility as all purpose indicators.

PACKAGE DIMENSIONS



FEATURES

- Low Cost
- High intensity light source with various lens effects
- Orange, green, yellow and red colors available. (See MV5074 series for additional red sources.)
- Versatile mounting on P.C. board or panel
- Long life—solid state reliability
- Low power requirements
- Compact, rugged, lightweight
- High efficiency
- Ultra high brightness
- "B"—designated products have 0.6" (15.2 mm) minimum lead length
- "C"—designated products have 1" (25.4 mm) minimum lead length
- Square leads (will fit into .020" [.508 mm] diameter holes)

ABSOLUTE MAXIMUM RATINGS

Power dissipation @ 25°C ambient	105 mW
Derate linearly from 25°C	1.14 mW/°C
Storage temperature	-55°C to 100°C
Operating temperature	-55°C to 100°C
Lead solder time @ 230°C (see Note 3)	5 sec
Continuous forward current @ 25°C	35 mA
Continuous forward current @ 100°C	10 mA
Peak forward current (1 μsec pulse, 0.3% duty cycle)	1.0 A
Reverse voltage	5.0 V

PHYSICAL CHARACTERISTICS

TYPE	SOURCE COLOR	LENS COLOR	LENS EFFECT	PACKAGE PROFILE
MV5174B/C	Orange	Orange diffused	Wide beam	High profile
MV5274B/C	Green	Green diffused	Wide beam	High profile
MV5374B/C	Yellow	Yellow diffused	Wide beam	High profile
MV5774B/C	Orange	Red diffused	Wide beam	High profile

ELECTRO-OPTICAL CHARACTERISTICS

PARAMETER	TEST COND.	UNITS	MV5174B/C	MV5274B/C	MV5374B/C	MV5774B/C
Forward voltage (V_F)						
Typ.	$I_F = 20 \text{ mA}$	V	2.0	2.2	2.1	2.0
Max.	$I_F = 20 \text{ mA}$	V	3.0	3.0	3.0	3.0
Luminous intensity (see Note 1)*						
Min.	$I_F = 20 \text{ mA}$	mcd	1.5	.4	1.5	1.5
Typ.	$I_F = 20 \text{ mA}$	mcd	5.0	1.0	4.0	5.0
Peak wave length	$I_F = 20 \text{ mA}$	nm	635	565	585	635
Spectral line	$I_F = 20 \text{ mA}$	nm	45	35	35	45
Half width						
Capacitance						
Typ.	$V = 0$	pF	45	45	45	45
Reverse voltage (V_R)						
Min.	$I_R = 100 \mu\text{A}$	V	5	5	5	5
Typ.	$I_R = 100 \mu\text{A}$	V	25	25	25	25
Reverse current (I_R)						
Max.	$V_R = 5.0 \text{ V}$	μA	100	100	100	100
Typ.	$V_R = 5.0 \text{ V}$	nA	20	20	20	20
Viewing angle (total)	See Fig. 3 & 4	degrees	90	90	90	90

*Luminous intensity guaranteed to a 2.5% AQL inspection plan per MIL-STD-105D.

TYPICAL ELECTRO-OPTICAL CHARACTERISTIC CURVES

(25°C Free Air Temperature Unless Otherwise Specified)

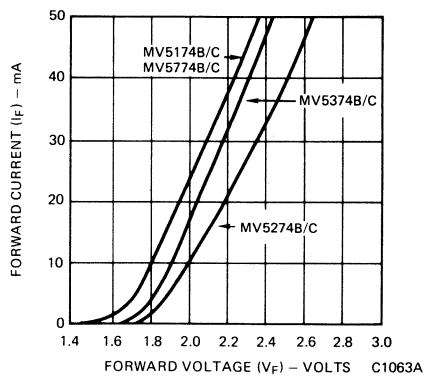


Fig. 1. Forward Current vs. Forward Voltage

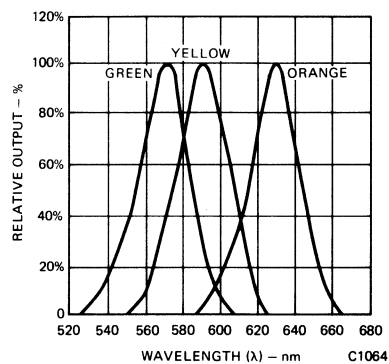


Fig. 2. Spectral Response

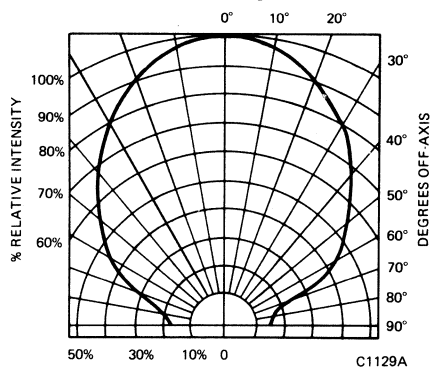


Fig. 3. Spatial Distribution

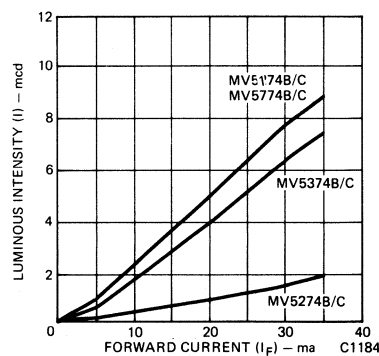


Fig. 4. Luminous Intensity vs. Forward Current

NOTES

- As measured with a Photo Research Corp. "SPECTRA" Microcandela Meter, Model IVD.
- The leads of the device were immersed in molten solder, at 230°C, to a point 1/16 inch from the body of the device per MIL-S-750.

Monsanto

SOLID STATE LAMPS

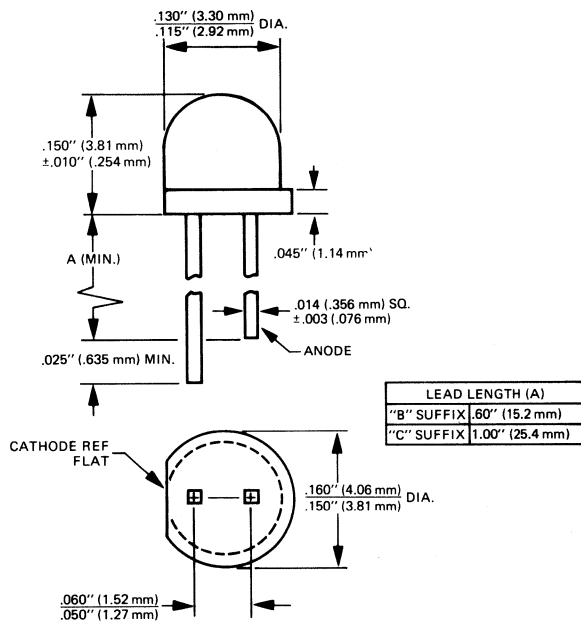
ORANGE
GREEN
YELLOW
IMPROVED RED

MV5177B/C
MV5277B/C
MV5377B/C
MV5777B/C

PRODUCT DESCRIPTION

These solid state indicators offer a variety of color selection. The orange, red, and yellow devices are made with gallium arsenide phosphide, and the green units are made with gallium phosphide. All are encapsulated in epoxy packages. Their small size (approximately T-1 size), good viewing angle, and small square leads contribute to their versatility as all purpose indicators.

PACKAGE DIMENSIONS



C1181

FEATURES

- Square leads (will fit into .020" [.508 mm] diameter hole)
- Compact size
- Bright (up to 3.0 mcd at 20 mA)
- Long life, rugged
- "B"—designated products have .6" (15.2 mm) minimum lead length
- "C"—designated products have 1" (25.4 mm) minimum lead length
- Mount on approximately 3/16" (4.72 mm) centers
- Orange, green, yellow, and red colors available (see MV5077 series for other red sources.)

ABSOLUTE MAXIMUM RATINGS

Power dissipation @ 25°C	105 mW
Derate linearly from 25°C	1.14 mW/°C
Storage temperature	-55°C to +100°C
Operating temperature	-55°C to +100°C
Continuous forward current (25°C)	35 mA
Peak forward current (1 μsec pulse width, 0.3% duty cycle)	1.0 A
Reverse voltage	5.0 V
Lead solder time (230°C, 1/16" from body)	5 sec

PHYSICAL CHARACTERISTICS

TYPE	SOURCE COLOR	LENS COLOR	LENS EFFECT	PACKAGE PROFILE
MV5177B/C	Orange	Orange diffused	Wide beam	Low profile
MV5277B/C	Green	Green diffused	Wide beam	Low profile
MV5377B/C	Yellow	Yellow diffused	Wide beam	Low profile
MV5777B/C	Orange	Red diffused	Wide beam	Low profile

ELECTRO-OPTICAL CHARACTERISTICS

PARAMETER	TEST COND.	UNITS	MV5177B/C	MV5277B/C	MV5377B/C	MV5777B/C
Forward voltage (V_F)						
Typ.	$I_F = 20 \text{ mA}$	V	2.0	2.2	2.1	2.0
Max.	$I_F = 20 \text{ mA}$	V	3.0	3.0	3.0	3.0
Luminous intensity (see Note 1)*						
Min.	$I_F = 20 \text{ mA}$	mcd	1.0	.2	1.0	1.0
Typ.	$I_F = 20 \text{ mA}$	mcd	3.0	0.6	2.0	3.0
Peak wave length	$I_F = 20 \text{ mA}$	nm	635	565	585	635
Spectral line	$I_F = 20 \text{ mA}$	nm	45	35	35	45
Half width						
Capacitance						
Typ.	$V = 0$	pF	45	45	45	45
Reverse voltage (V_R)						
Min.	$I_R = 100 \mu\text{A}$	V	5	5	5	5
Typ.	$I_R = 100 \mu\text{A}$	V	25	25	25	25
Viewing angle (total) (Fig. 5)		degrees	180	180	180	180
Dynamic resistance (R_D)		Ω	7.0	7.0	7.0	7.0

*Luminous intensity guaranteed to a 2.5% AQL inspection plan per MIL-STD-105D.

TYPICAL ELECTRO-OPTICAL CHARACTERISTIC CURVES

(25°C Free Air Temperature Unless Otherwise Specified)

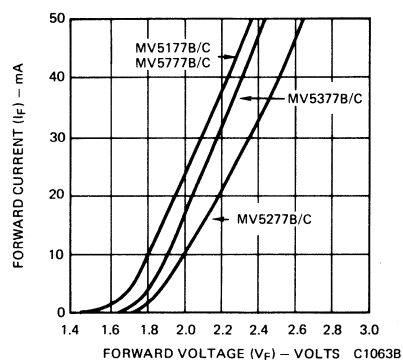


Fig. 1. Forward Current vs. Forward Voltage

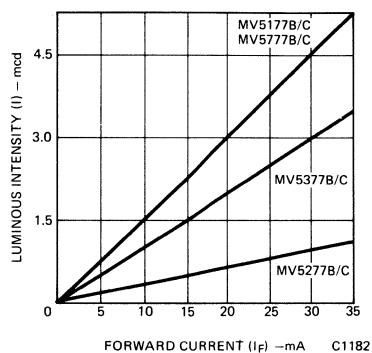


Fig. 2. Luminous Intensity vs. Forward Current

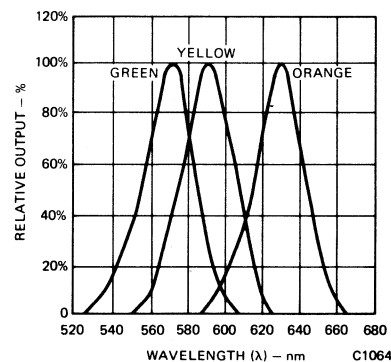


Fig. 3. Spectral Response

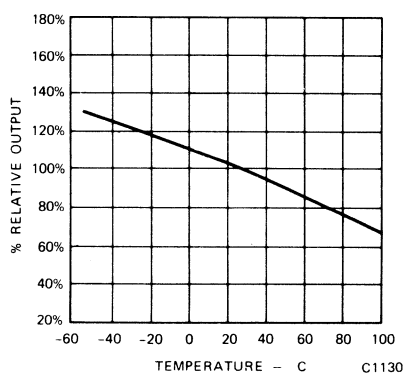


Fig. 4. Percent Relative Response vs. Temperature

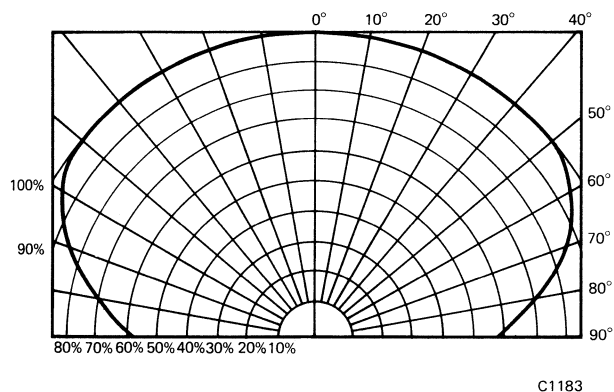


Fig. 5. Spatial Distribution

NOTES

1. Luminous intensity measurements are taken with a Photo Research Corp., "SPECTRA" Microcandela Meter Model IVD.

Monsanto

MV53124 SOLID STATE INDICATOR

FEATURES

- .220" x .125" lighted area
- Stackable in X or Y direction
- High brightness—typically 4 mcd @ 20 mA
- Solid state reliability
- Compact, rugged, lightweight
- No light leakage from unit or sides

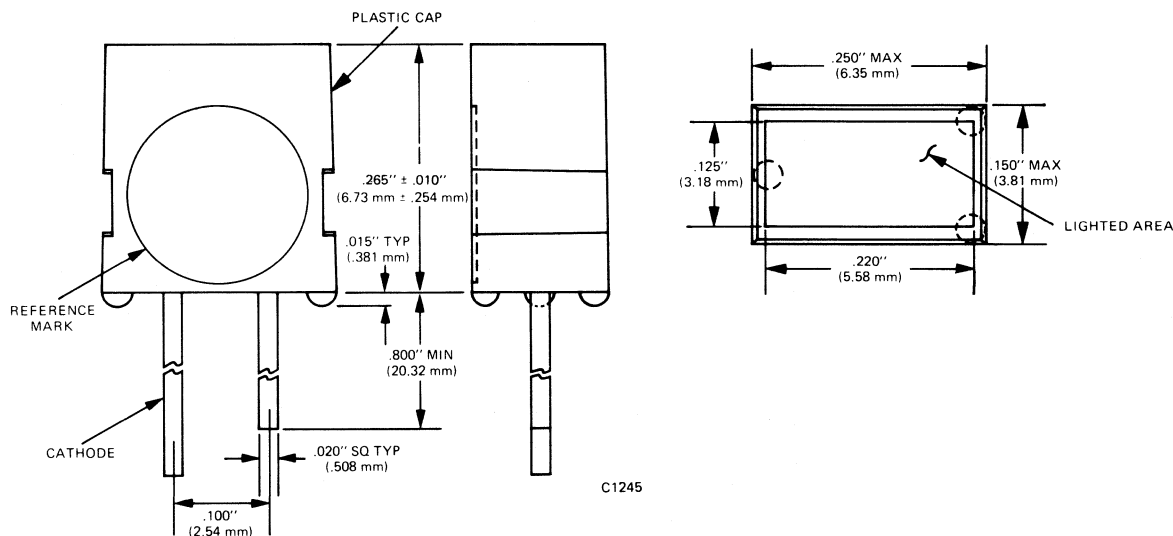
APPLICATIONS

- Legend backlighting
- Illuminated pushbutton
- Panel indicator
- Bargraph meter

PRODUCT DESCRIPTION

The MV53124 is a bright yellow, rectangularly shaped light source. The rectangular, lighted area is uniformly lit by a GaAsP on GaP high performance LED chip.

PACKAGE DIMENSIONS



ABSOLUTE MAXIMUM RATINGS

Power dissipation @ 25°C 105 mW
 Derate linearly from 25°C 1.14 mW/°C
 Storage temperature -55°C to 100°C
 Operating temperature -55°C to 100°C

Peak forward current 1 AMP
 (1 μsec pulse width, 300 pps)
 Forward current @ 25°C 35 mA
 Lead solder time @ 260°C (see Note 1) 5 seconds
 Reverse voltage 5.0 volts

ELECTRO-OPTICAL CHARACTERISTICS

PARAMETER	SYM	MIN	TYP	MAX	UNITS	TEST CONDITIONS
Forward voltage	V_F		2.0	3.0	V	$I_F = 20$ mA
Luminous intensity*		1.0	4.0		mcd	$I_F = 20$ mA
Peak wavelength			585		nm	$I_F = 20$ mA
Spectral line half width			45		nm	$I_F = 20$ mA
Reverse voltage	V_R	5	25		V	$I_R = 100$ μ A
Reverse current	I_R		.020	100	μ A	$V_R = 5.0$ V
Capacitance			45		pF	$V = 0$

*Luminous intensity guaranteed to a 2.5% AQL inspection plan per MIL-STD-105D.

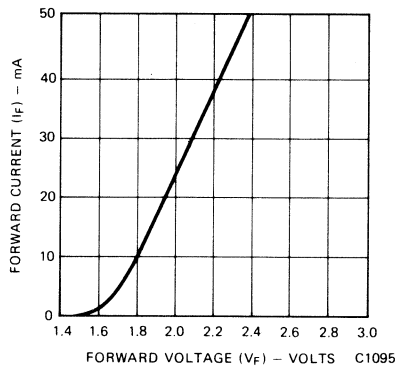


Fig. 1. Forward Current vs. Forward Voltage

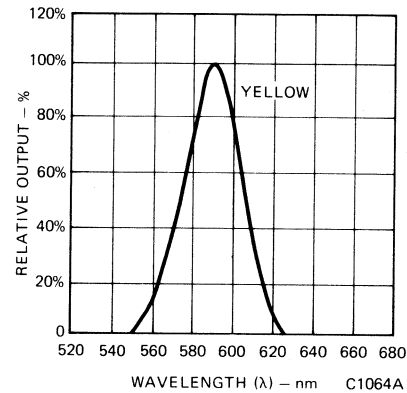


Fig. 2. Spectral Response

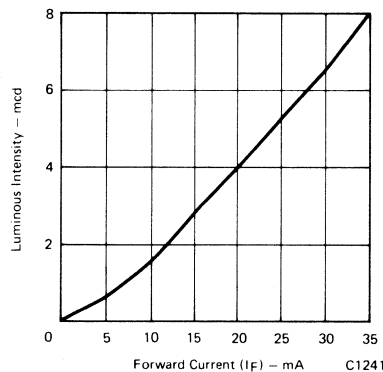


Fig. 3. Luminous Intensity vs. Forward Current
(see Note 2)

NOTES

1. The leads of the device were immersed in molten solder, heated to a temperature of 260°C, to a point 1/16 inch from the body of the device per MIL-S-750, with dwell time of 5 sec.
2. As measured with a Photo Research Spectra Corp. Microcandela Meter (Model IV D).

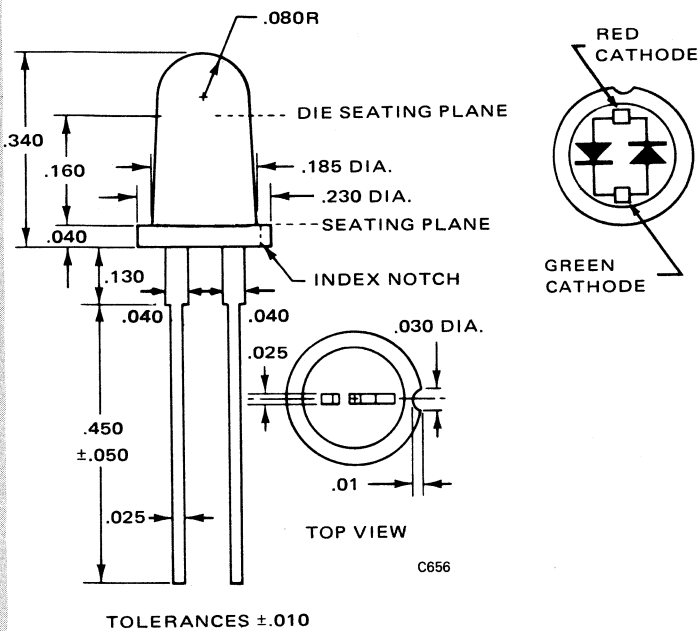
Monsanto

MV5491 RED/GREEN TRI-STATE LAMP

PRODUCT DESCRIPTION

A green and red lamp made of GaAsP (Red) and GaP (Green) offering a changing color dependent on the direction the lamp is biased. These two light emitting diodes are mounted in the same convenient epoxy package.

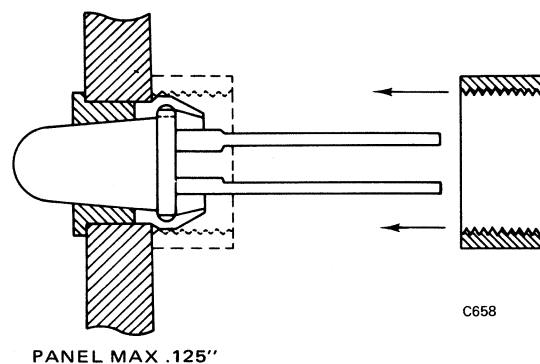
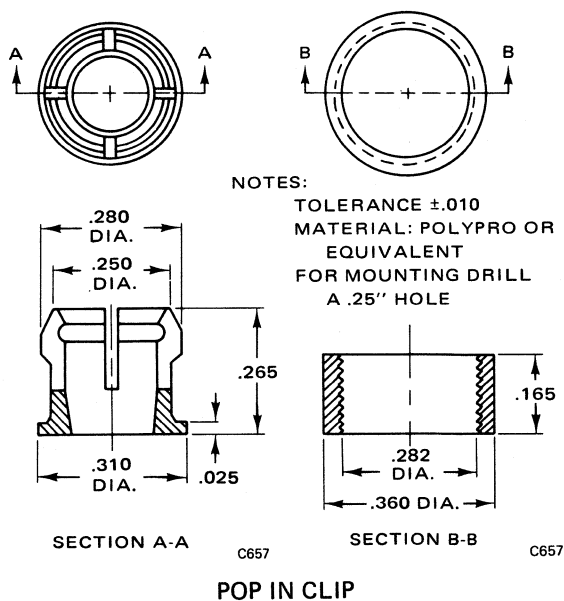
PACKAGE DIMENSIONS



FEATURES

- Bright
- Long life, rugged
- True polarity indicating
- 3 states: Green, Red, Off
- Solid state
- Integrated circuit compatible
- Convenient mounting clip available
- Versatile mounting on P.C. board or panel

MOUNTING TECHNIQUES



PANEL MOUNTING

ABSOLUTE MAXIMUM RATINGS

Power Dissipation @ 25°C (Peak or Continuous)	200 mW
Storage & Operating Temp.	-55°C to 100°C
Currents	
Red ON (Peak or Continuous, 25°C)	70 mA
Green ON (Peak or Continuous, 25°C)	35 mA
Derate linearly from 25°C	
Red	-1.66 mW/°C
Green	-2.66 mW/°C
Lead solder time @ 230°C	5 sec

ELECTRO-OPTICAL CHARACTERISTICS (25°C Ambient Temperature Unless Specified Otherwise)**OPTICAL**

	MIN.	TYP.	MAX.	UNITS	CONDITIONS
Luminous Intensity (I) (note 2)					
Red		1.5		mcd	I _F = 20 mA
Green		.5		mcd	I _F = 20 mA
Apparent Area (A _P)		32		cm ²	(X10 ⁻³)
Wavelength (λ _p k)					
Red		660		nm	I _F = 20 mA
Green		560		nm	I _F = 20 mA
Spectral Half Width					
Red		20		nm	I _F = 20 mA
Green		30		nm	I _F = 20 mA

ELECTRICAL

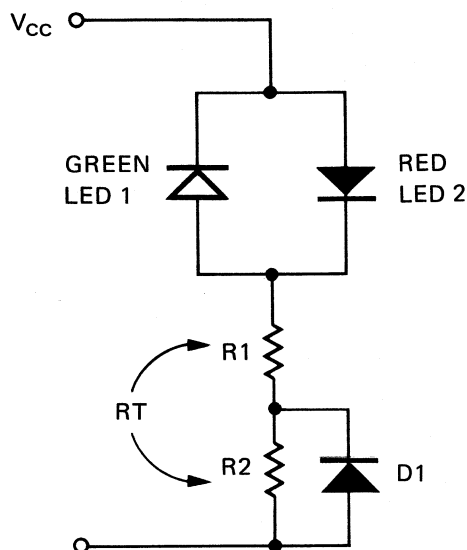
Forward Voltage (V _F)					
Red		1.65	2.0	volts	I _F = 20 mA
Green		2.2	3.0	volts	I _F = 30 mA
Dynamic Resistance (R _D)					
Red		5.5		Ω	
Green		50.0		Ω	

THERMAL CHARACTERISTICS

	MIN.	TYP.	MAX.	UNITS	CONDITIONS
Forward Voltage Temp. Coefficient					
Red		-1.5		mV/°C	I _F = 20 mA
Green		-3.0		mV/°C	I _F = 20 mA

BIASING NETWORK

$V_{CC} = 5V$
 $D_1 = 1N914$ (or equivalent)



$$R_T = \frac{V_{CC} - V_{LED2}}{I_{LED2}}$$

$$R_1 = \frac{V_{CC} - (V_{LED1} + V_{D1})}{I_{LED1}}$$

Example: Match Intensities of both red and green units at 30 mA and 50 mA respectively.

FOR RED:

FOR GREEN:

$$R_T = \frac{V_{CC} - V_{LED2}}{I_{LED2}}$$

$$R_1 = \frac{V_{CC} - (V_{LED1} + V_{D1})}{I_{LED1}}$$

$$= \frac{5.0 - 1.63}{0.3}$$

$$= \frac{5.0 - (2.6 + 0.7)}{.05}$$

$$= 112\Omega$$

$$= 34\Omega$$

$$R_T - R_1 = R_2$$

$$112 - 34 = 78\Omega$$

SUGGESTED RESISTOR COMBINATIONS:

	GREEN → 10 mA			20 mA			30 mA			40 mA			50 mA		
RED	R_T	R_1	R_2	R_T	R_1	R_2	R_T	R_1	R_2	R_T	R_1	R_2	R_T	R_1	R_2
10 mA	344	230	114	344	102	242	344	63	281	344	44	300	344	34	310
20 mA	170	230	-60	170	102	68	170	63	107	170	44	126	170	34	136
30 mA	112	230	-118	112	102	10	112	63	49	112	44	68	112	34	78
40 mA	84	230	-146	84	102	-18	84	63	21	84	44	40	84	34	50
50 mA	67	230	-163	67	102	-35	67	63	4	67	44	23	67	34	33
60 mA	55	230	-175	55	102	-47	55	63	-8	55	44	11	55	34	21
70 mA	47	230	-183	47	102	-55	47	63	-16	47	44	3	47	34	13

- NOTES: 1) All values are in ohms
 2) $V_{CC} = 5$ volts D.C.
 3) Current combinations in shaded area not possible with circuit shown

Note: Values computed are for maximum currents through each diode.

TYPICAL ELECTRO-OPTICAL CHARACTERISTICS

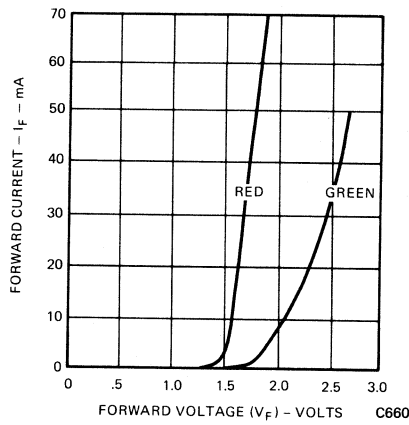


Fig. 1. Forward Current vs Forward Voltage

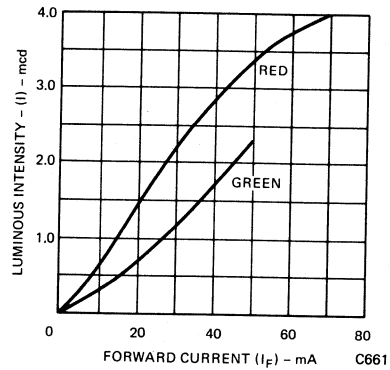


Fig. 2. Luminous Intensity vs Forward Current

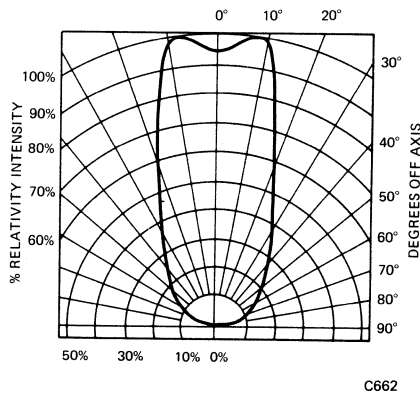


Fig. 3. Spatial Distribution (Note 1)

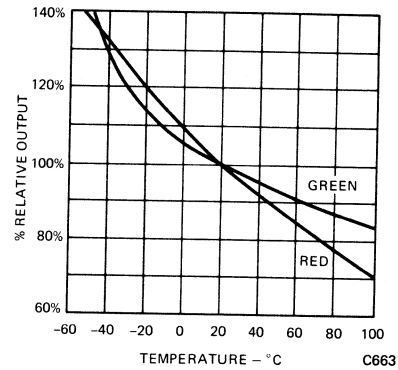


Fig. 4. Relative Output vs Temperature

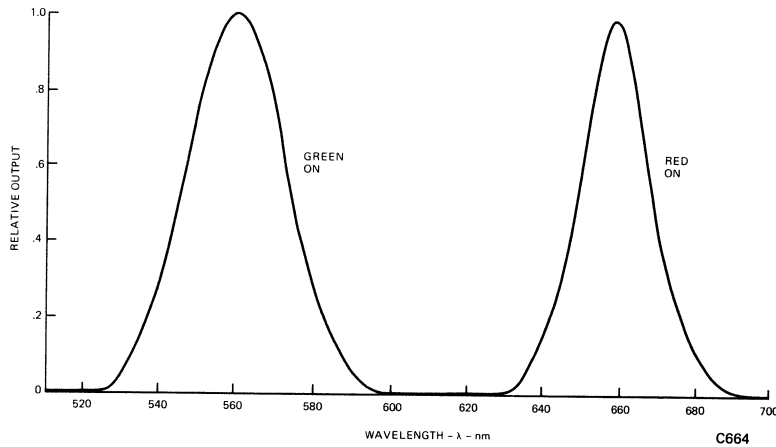


Fig. 5. Spectral Distribution

NOTES

1. The axis of spatial distribution are typically within a 10° cone with reference to the central axis of the device.
2. Luminous Intensity figures are measured with a Photo Research Corp. Microcandela Meter (Model IV D).

Monsanto

MV57124 SOLID STATE INDICATOR

FEATURES

- .220" x .125" lighted area
- Stackable in X or Y direction
- High brightness—typically 4 mcd @ 20 mA
- Solid state reliability
- Compact, rugged, lightweight
- No light leakage from unit or sides

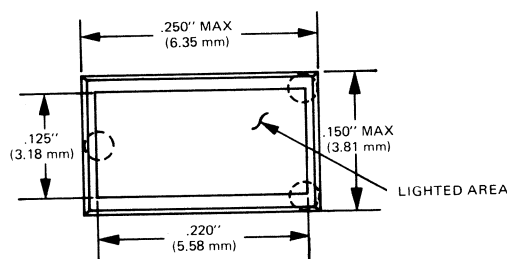
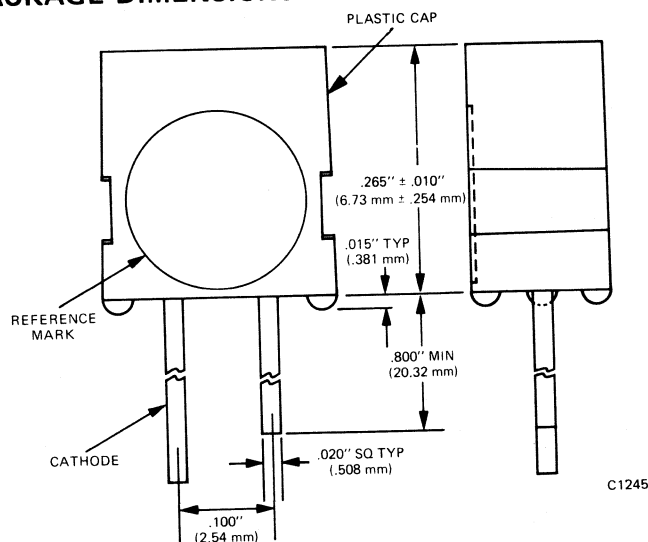
APPLICATIONS

- Legend backlighting
- Illuminated pushbutton
- Panel indicator
- Bargraph meter

PRODUCT DESCRIPTION

The MV57124 is a bright red, rectangularly shaped light source. The rectangular, lighted area is uniformly lit by a GaAsP on GaP high performance LED chip.

PACKAGE DIMENSIONS



ABSOLUTE MAXIMUM RATINGS

Power dissipation @ 25°C	105 mW
Derate linearly from 25°C	1.14 mW/°C
Storage temperature	-55°C to 100°C
Operating temperature	-55°C to 100°C

Peak forward current	1 AMP
(1 μsec pulse width, 300 pps)	
Forward current @ 25°C	35 mA
Lead solder time @ 230°C	5 seconds
Reverse voltage	5.0 volts

ELECTRO-OPTICAL CHARACTERISTICS

PARAMETER	SYM	MIN	TYP	MAX	UNITS	TEST CONDITIONS
Forward voltage	V_F		2.0	3.0	V	$I_F = 20 \text{ mA}$
Luminous intensity		1.0	4		mcd	$I_F = 20 \text{ mA}$
Peak wavelength			635		nm	$I_F = 20 \text{ mA}$
Spectral line half width			45		nm	$I_F = 20 \text{ mA}$
Reverse voltage	V_R	5	25		V	$I_R = 100 \mu\text{A}$
Reverse current	I_R		.020	100	μA	$V_R = 5.0 \text{ V}$
Capacitance			45		pF	$V = 0$

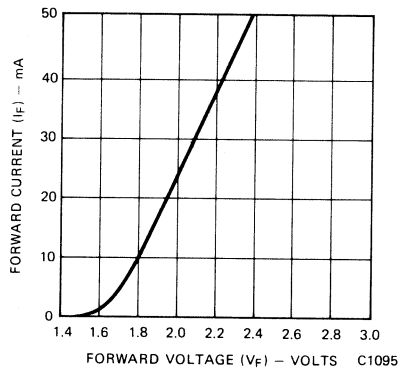


Fig. 1. Forward Current vs. Forward Voltage

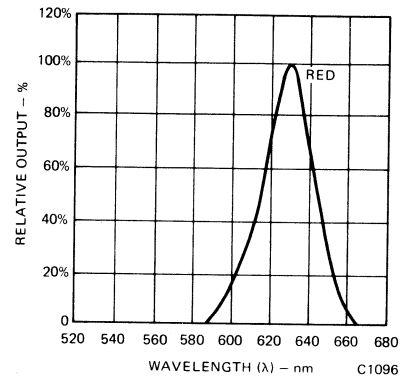


Fig. 2. Spectral Response

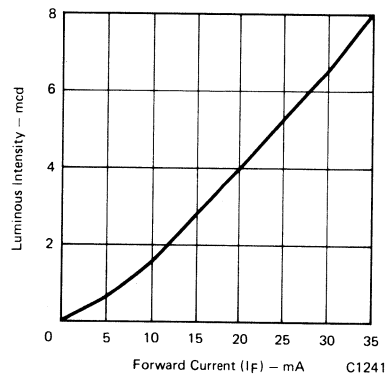


Fig. 3. Luminous Intensity vs. Forward Current

ELECTRO-OPTICAL CHARACTERISTICS

PARAMETER	TEST COND.	UNITS	MV5753	MV5754
Forward voltage (V_F)				
Typ.	$I_F = 20 \text{ mA}$	V	2.0	2.0
Max.	$I_F = 20 \text{ mA}$	V	3.0	3.0
Luminous intensity (see Note 1)*				
Min.	$I_F = 20 \text{ mA}$	mcd	3.0	3.0
Typ.	$I_F = 20 \text{ mA}$	mcd	6.0	8.0
Peak wave length	$I_F = 20 \text{ mA}$	nm	635	635
Spectral line	$I_F = 20 \text{ mA}$	nm	45	45
Half width				
Capacitance				
Typ.	$V = 0$	pF	45	45
Reverse voltage (V_R)				
Min.	$I_R = 100 \mu\text{A}$	V	5	5
Typ.	$I_R = 100 \mu\text{A}$	V	25	25
Reverse current (I_R)				
Max.	$V_R = 5.0 \text{ V}$	μA	100	100
Typ.	$V_R = 5.0 \text{ V}$	nA	20	20
Viewing angle (total)	See Fig. 3 & 4	degrees	65	24

*Luminous intensity guaranteed to a 2.5% AQL inspection plan per MIL-STD-105D.

TYPICAL ELECTRO-OPTICAL CHARACTERISTIC CURVES

(25°C Free Air Temperature Unless Otherwise Specified)

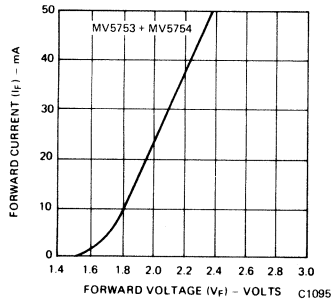


Fig. 1. Forward Current vs. Forward Voltage

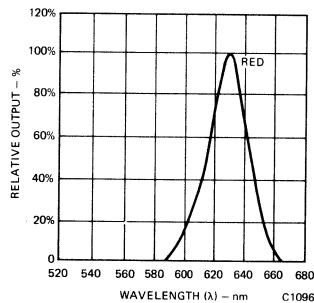


Fig. 2. Spectral Response

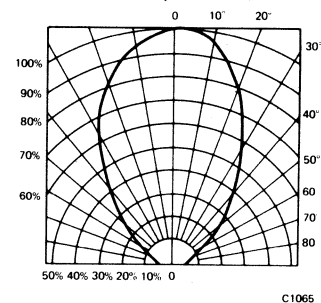


Fig. 3. Spatial Distribution (Note 2) for MV5753

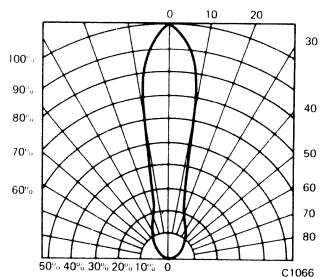


Fig. 4. Spatial Distribution (Note 2) for MV5754

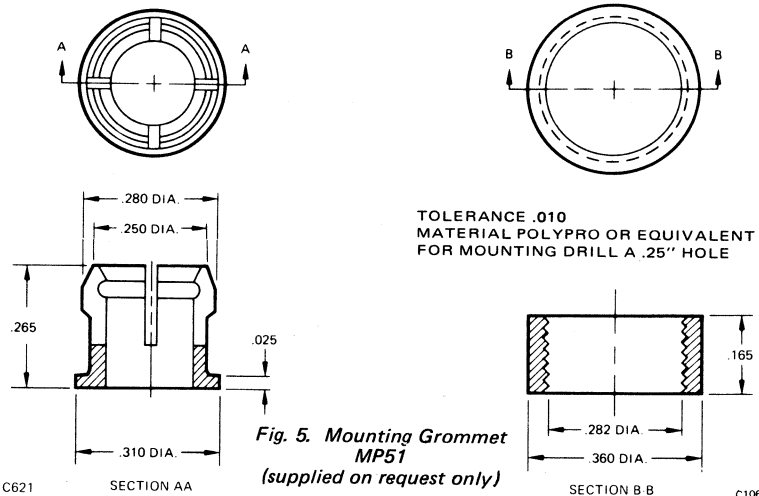


Fig. 5. Mounting Grommet MP51 (supplied on request only)

NOTES

1. As measured with a Photo Research Corp. "SPECTRA" Microcandela Meter (Model IV D).
2. The axes of spatial distribution are typically within a 10° cone with reference to the central axis of the device.
3. The leads of the device were immersed in molten solder, at 260°C, to a point 1/16 inch from the body of the device per MIL-S-750.

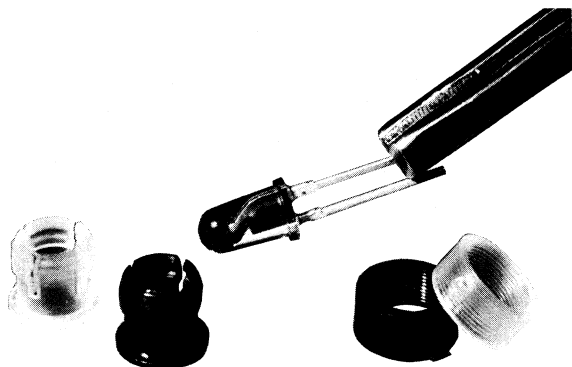
Monsanto

PANEL MOUNTING GROMMETS (FOR LED PANEL INDICATORS)

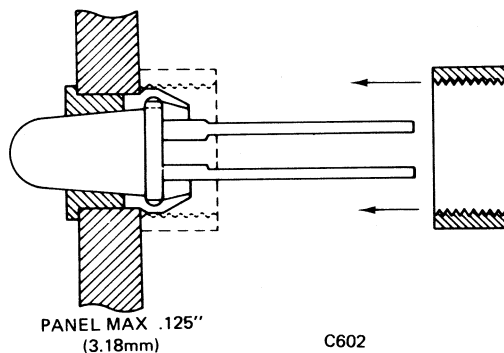
**MP21 MP51
MP22 MP52**

DESCRIPTION

The MP Series of mounting grommets is intended for panel mounting of many standard Monsanto light emitting diode indicators. The grommets are made of plastic and are available in clear and black. The MP Series will easily mount the applicable lamps on any panel thickness up to .125 inch (3.18mm).

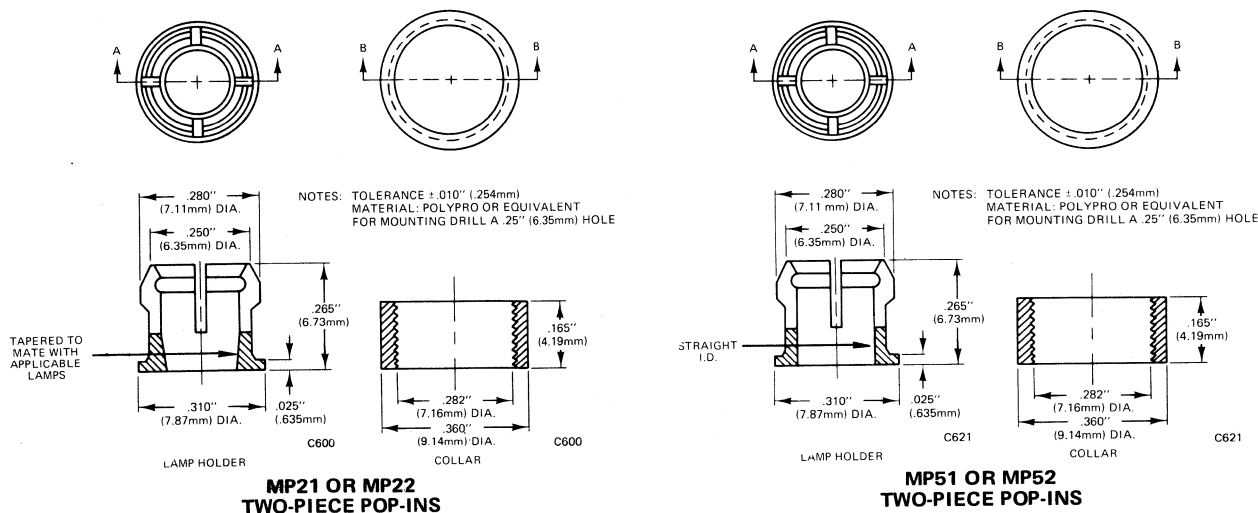


TYPICAL MOUNTING TECHNIQUE



PART NUMBER	COLOR	AVAILABILITY	APPLICABLE LAMPS
MP21	CLEAR	Special order only	} MV5020 thru MV5026; ME7120 thru ME7124
MP22	BLACK	Standard	
MP51	CLEAR	Special order only	} MV5050 thru MV5056; MV5153; MV5154; MV5253, MV5254; MV5353, MV5354
MP52	BLACK	Standard	

DIMENSIONAL DATA



4 IR EMITTERS, DETECTORS, SENSORS

Infrared Emitters, Detectors, Sensors

QUICK REFERENCE CHART

INFRARED EMITTERS

MODEL NO.	FORWARD VOLTAGE (V _F)	POWER OUT (P _o)	TEST CURRENT	MAXIMUM POWER
ME60	1.3 V	550 μ W	50 mA	75 mW
ME61	1.3 V	550 μ W	50 mA	75 mW
ME7021 (Note a)	1.3 V	1000 μ W	50 mA	150 mW
ME7024 (Note a)	1.3 V	1000 μ W	50 mA	150 mW
ME7121 (Note a)	1.4 V	3 mW	50 mA	150 mW
ME7124 (Note a)	1.4 V	3 mW	50 mA	150 mW
ME7161	1.3 V	3 mW	50 mA	75 mW

NOTE:

(a) The ME7021 and ME7121 have a 15° half-angle; the ME7024 and ME7124 have a 4° half-angle.

PHOTODETECTORS

MODEL NO.	SENSITIVITY (μ A/mW/cm ²)	COLLECTOR DARK CURRENT	COLLECTOR-EMITTER BREAKDOWN	MAXIMUM POWER
MT1	560	1 nA	65 V	200 mW
MT2	1400	1 nA	65 V	200 mW
MT8020	350	1.5 nA	65 V	200 mW

SENSOR SYSTEMS

MODEL NO.	OUTPUT FORMAT	PACKAGE TYPE	COLLECTOR CURRENT (I _C)	TYPICAL BANDWIDTH	MAX. DARK CURRENT (I _{CEO})
MCA7	DARLINGTON	REFLECTIVE SENSOR SWITCH	50 μ A @ I _F = 50 mA, V _{CE} = 5 V	0.8 kHz	100 nA
MCT8	TRANSISTOR	SLOTTED LIMIT SWITCH	200 μ A @ I _F = 20 mA, V _{CE} = 10 V	150 kHz	100 nA
MCT81	TRANSISTOR	SLOTTED LIMIT SWITCH	50 μ A @ I _F = 20 mA, V _{CE} = 10 V	200 kHz	100 nA
MCA8	DARLINGTON	SLOTTED LIMIT SWITCH	2 mA @ I _F = 16 mA, V _{CE} = 1 V	0.8 kHz	100 nA
MCA81	DARLINGTON	SLOTTED LIMIT SWITCH	1.6 mA @ I _F = 50 mA, V _{CE} = 1 V	1.5 kHz	100 nA

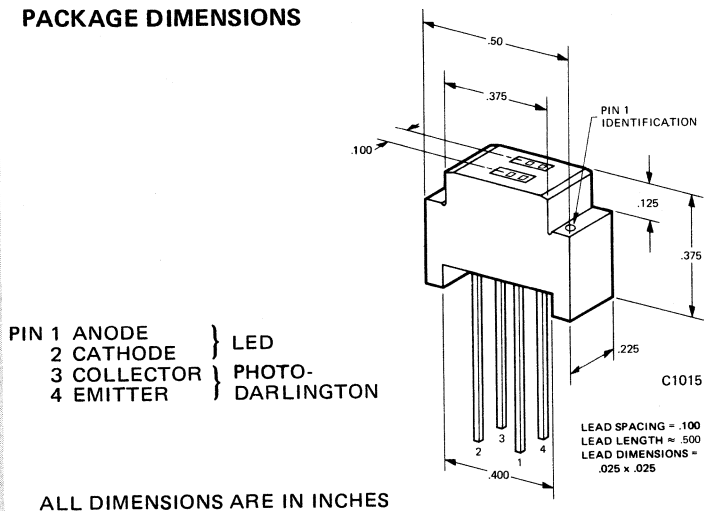
Monsanto

MCA7 REFLECTIVE OBJECT SENSOR

PRODUCT DESCRIPTION

The MCA7 opto-isolator consists of an infrared emitting diode and a silicon planar photo darlington. The on-axis radiation of the emitter and the on-axis response of the detector are both perpendicular to the face of the MCA7. The photo-darlington responds to radiation emitted from the diode only when a reflective object or surface is in the field of view of the detector.

PACKAGE DIMENSIONS



ALL DIMENSIONS ARE IN INCHES

FEATURES

- High sensitivity
- Low Cost
- High reliability

APPLICATIONS

- Object sensing
- End-of-tape sensing

ABSOLUTE MAXIMUM RATINGS

Storage Temperature	-55°C to 100°C
Operating Temperature	-55°C to 100°C
Lead Temperature (Soldering, 5 sec)	260°C
Total Power Dissipation (25° Free Air Temp.)	250 mW
Derate linearly from 25°C	3.3 mW/°C

INPUT DIODE

Power dissipation at 25°C ambient	150 mW
Derate Linearly from 25°C	2.0 mW/°C
Forward DC current	75 mA
Reverse current	10 mA
Peak forward current (1 μs pulse, 300 pps)	3.0 A

OUTPUT DARLINGTON

Power dissipation at 25°C Ambient	150 mW
Derate linearly from 25°C	2.0 mW/°C
Collector Current	25 mA
Collector to emitter voltage	30 V

ELECTRO-OPTICAL CHARACTERISTICS (25°C Free Air Temperature Unless Otherwise Specified)

CHARACTERISTIC	SYMBOL	MIN.	TYP.	MAX.	UNITS	TEST CONDITIONS
INPUT DIODE						
Forward Voltage	V_F		1.25	1.50	V	$I_F = 20 \text{ mA}$
Reverse Breakdown Voltage	BV_R	3.0	5.5		V	$I_R = 10 \mu\text{A}$
Junction Capacitance	C_j		50		pF	$V_F = 0\text{V}$
Reverse Leakage Current	I_R		.01	10	μA	$V_R = 3.0\text{V}$
OUTPUT DARLINGTON						
Breakdown Voltage	BV_{CEO}	30	55		V	$I_C = 1.0 \text{ mA}$ $I_F = 0$ (NOTE 2)
Reverse Breakdown Voltage	BV_{ECO}	5	7		V	$I_C = 100 \mu\text{A}$ $I_F = 0$ (NOTE 2)
Leakage Current	I_{CEO} (dark)		5	100	nA	$V_{CE} = 5\text{V}$ (NOTE 2), $I_F = 0$
Leakage Current	I_{CEO} (ambient)		6.8		mA	$V_{CE} = 5\text{V}$ (NOTE 3), $I_F = 0$
Rise Time, Fall Time			0.6		mS	$V_{CE} = 5\text{V}$, $R_L = 1\text{k}\Omega$
COUPLED						
DC Current Transfer Ratio	(CTR)	.050	1		mA	$I_F = 50 \text{ mA}$ $V_{CE} = 5.0\text{V}$ (NOTE 1 & 2) $d = 1.0 \text{ CM}$

TYPICAL ELECTRO-OPTICAL CHARACTERISTIC CURVES (25°C Free Air Temperature Unless Otherwise Specified)

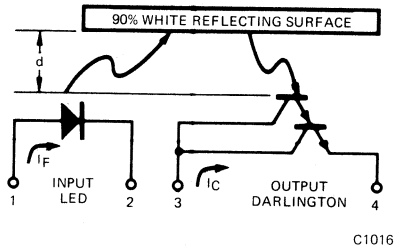


Figure 1 Parameter Symbols

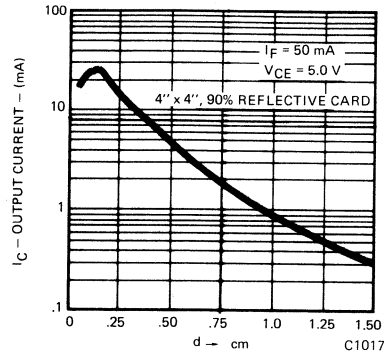


Figure 2 Output Current vs. Distance

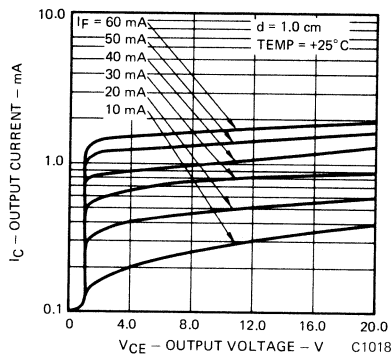


Figure 3 I_C vs. V_{CE}

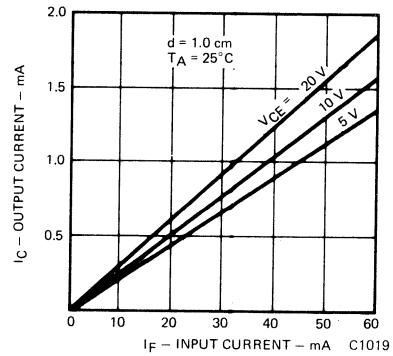


Figure 4 I_C vs. I_F

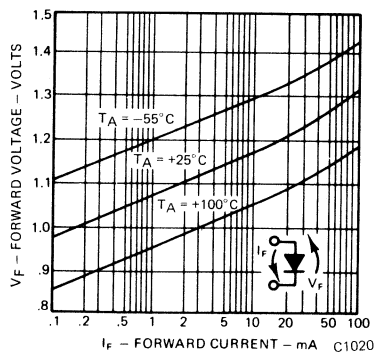


Figure 5 Forward Voltage vs. Forward Current

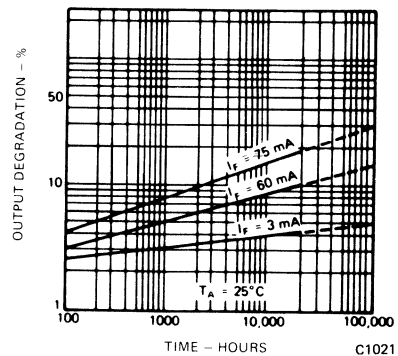


Figure 6 Lifetime vs. Forward Current

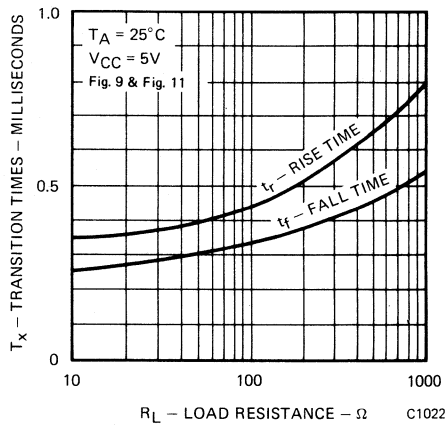


Figure 7. Non-Saturated Rise and Fall Times vs. Load Resistance

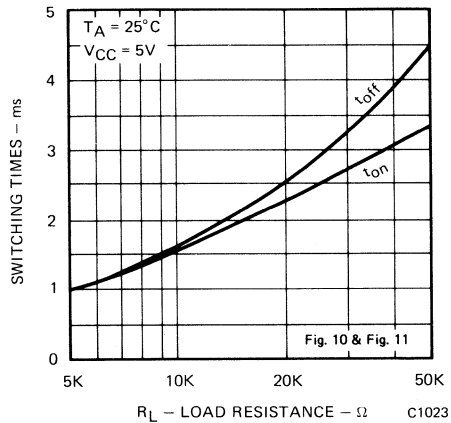


Figure 8. Saturated Switching Times vs. Load Resistance

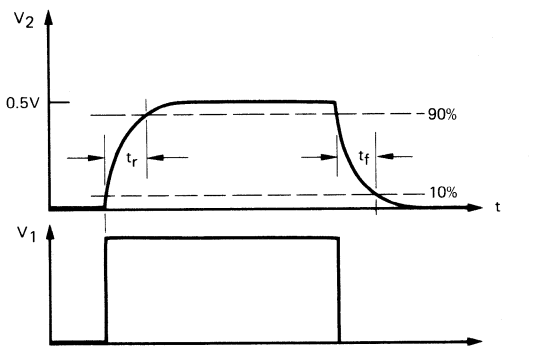


Figure 9. Non-Saturated Switching Waveforms

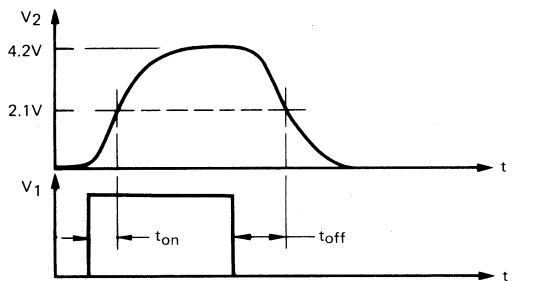


Figure 10. Saturated Switching Waveforms

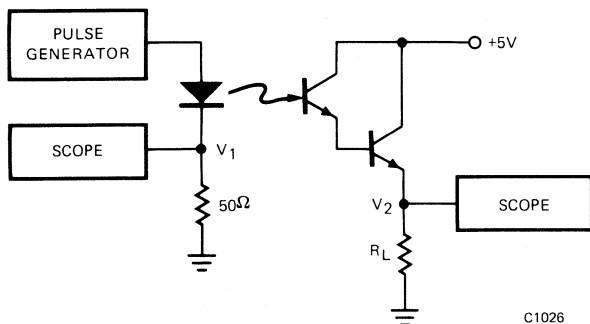


Figure 11. Circuit for Testing Switching Parameters

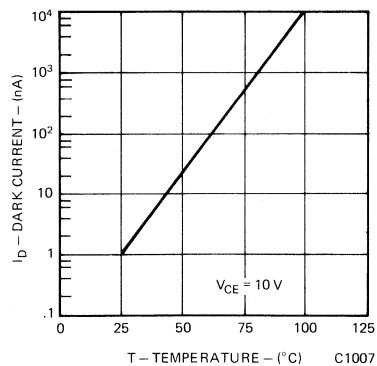
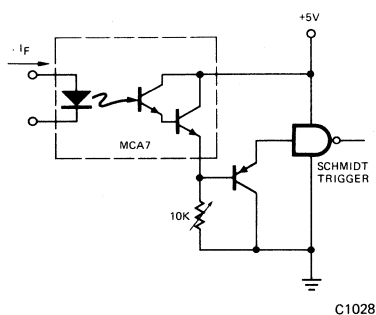
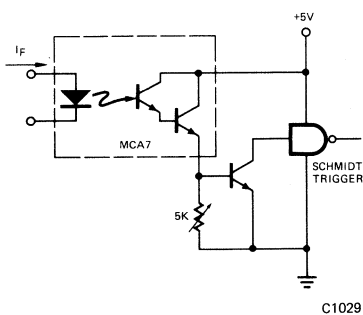


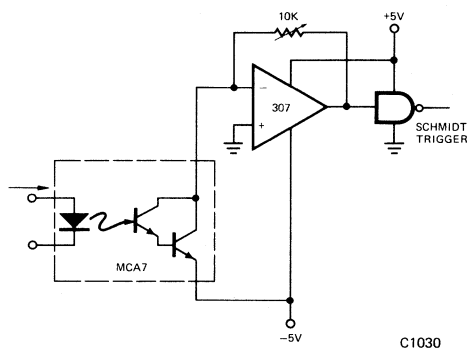
Figure 12. Dark Current vs. Temperature

CIRCUITS TO INTERFACE THE MCA7 WITH 5V LOGIC

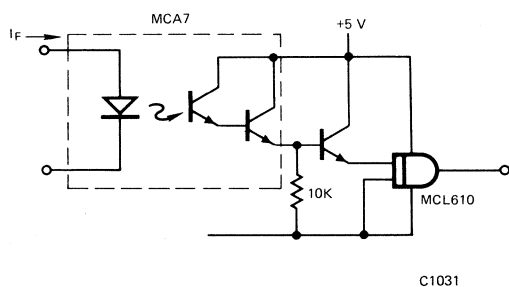
Circuit 1

Normally High Output

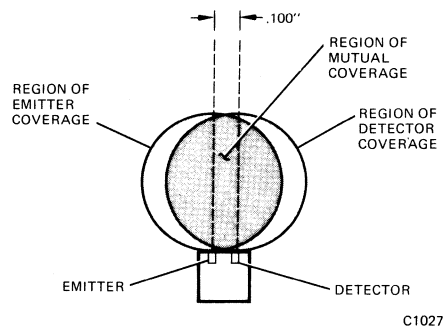
Circuit 2

Normally Low Output

Circuit 3

Comparator Driver

Circuit 4

Booster Drive to Logic Isolator**Spatial Distribution of Maximum Sensitivity****NOTES:**

1. Photo current is obtained from a 4.0" x 4.0", 90% white surface placed at a distance of 1.0 cm from the surface of the MCA7.
2. Measured with radiation flux intensity of less than 0.1 $\mu\text{W}/\text{cm}^2$ (dark condition) over the spectrum from 0.1 micron to 1.5 microns.
3. Measured at typical factory ambient of 150 foot-candles (150 lamberts per square foot).

Monsanto

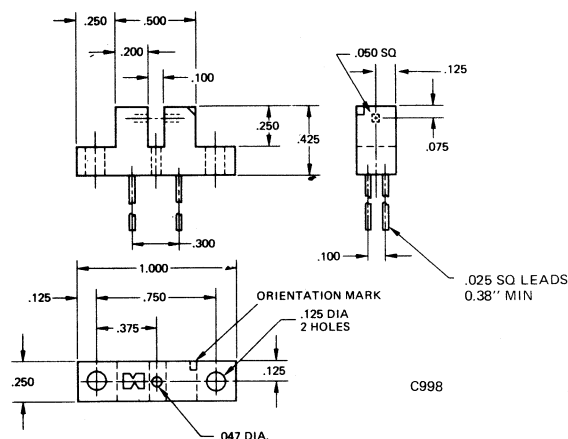
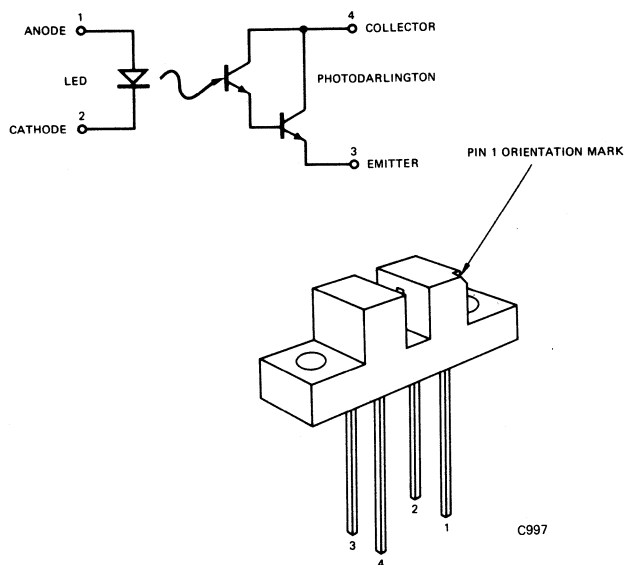
MCA8 MCA81

SLOTTED OPTICAL LIMIT SWITCH

PRODUCT DESCRIPTION

The MCA8 optical limit switch transmits light from a GaAs infrared emitting diode to a silicon photodarlington detector. Both semiconductor chips face each other across an .1-inch air gap. The MCA8 senses an object that interrupts the beam. Output current will directly operate a TTL Schmidt trigger.

PACKAGE DIMENSIONS



All dimensions are in inches.
Active area of LED is .014 x .014
Active area of PhotoDarlington is .010 x .020
Dimensions \pm .010 inches

FEATURES

- High Sensitivity permits direct interface with TTL logic.
- Modular construction permits low cost package modification to suit any application.
- Recessed detector provides a high signal to noise ratio in ambient light.
- Plugs into standard DIP socket.
- Multiple flat reference surfaces allow precise mechanical alignment of the optical beam.
- Absence of lensing provides position sensitivity down to 0.020" between full on and full off.
- Solid copper lead-frame provides excellent heat sinking and highest reliability for the LED.
- One piece construction of the emitter and detector components provides excellent moisture resistance, immunity from thermal shocks, high and low temperature stability, and protection from shock and vibration.

APPLICATIONS

- Optical shaft position and velocity monitor using a digitally encoded disk mounted on a shaft.
- Optical sensing of holes in paper, paper tape, IBM card, or magnetic tape.
- Optical sensing of marks on paper, paper tape, or IBM card.
- End of tape sensor using a transparent section of tape, a reflective strip on the tape, or a hole in the tape.
- End of film sensor for films not affected by infra-red light.
- Limit switch for mechanical travel such as cam switches, pressure switches, machine tool limit switches, foot pedal switches, safety interlock switches.
- Edge sensor for sheet materials such as paper, plastic film, fabric, foil, newsprint, belt sanders, reproduction paper.
- Fiber continuity monitor for fibers such as yarn, wire, thread.
- Fluid volume monitor by sensing turbine vanes passing through the slot.
- Liquid level detector of an opaque liquid.

ELECTRO-OPTICAL CHARACTERISTICS (25°C Free Air Temperature Unless Otherwise Specified)

CHARACTERISTIC	SYMBOL	MIN.	TYP.	MAX.	UNITS	TEST CONDITIONS
INPUT DIODE						
Forward Voltage	V_F		1.25	1.5	V	$I_F = 20 \text{ mA}$
Reverse Breakdown Voltage	BV_R	3.0	25		V	$I_R = 10 \text{ } \mu\text{A}$
Reverse Leakage Current	I_R		.01	10	μA	$V_R = 3 \text{ V}$
Junction Capacitance			50		pF	$V_F = 0$
OUTPUT DARLINGTON—MCA8						
Saturation Voltage	$V_{CE(SAT)}$		0.8	1.0	V	$I_C = 2 \text{ mA}, I_F = 16 \text{ mA}$ (Note 1)
Collector Breakdown Voltage	BV_{CEO}	30	55		V	$I_C = 1 \text{ mA}, I_F = 0$ (Note 1)
Emitter Breakdown Voltage	BV_{ECO}	5	7		V	$I_C = 100 \text{ } \mu\text{A}, I_F = 0$ (Note 2)
Dark Current—MCA8	I_{CEO}		5	100	nA	$V_{CE} = 5.0 \text{ V}, I_F = 0$ (Note 1)
Ambient Leakage Current			20		μA	$V_{CE} = 5.0 \text{ V}, I_F = 0$ (Note 2)
Rise Time	t_r		2.3		ms	$V_{CE} = 5 \text{ V}, R_L = 1 \text{ K}\Omega$
Fall Time	t_f		1.7		ms	$V_{CE} = 5 \text{ V}, R_L = 1 \text{ K}\Omega$
Turn-on Time	t_{ON}		.3		ms	$I_F = 12 \text{ mA}, \text{FIG 12}$
Turn-off Time	t_{OFF}		1.0		ms	$I_F = 12 \text{ mA}, \text{FIG 12}$
DC Current Transfer Ratio	CTR	15	30		%	$I_F = 16 \text{ mA}, V_{CE} = 5 \text{ V}$
OUTPUT DARLINGTON—MCA81						
Saturation Voltage	$V_{CE(SAT)}$		0.8	1.0	V	$I_C = 1.6 \text{ mA}, I_F = 50 \text{ mA}$ (Note 1)
Collector Breakdown Voltage	BV_{CEO}	30	55		V	$I_C = 1 \text{ mA}, I_F = 0$ (Note 1)
Emitter Breakdown Voltage	BV_{ECO}	5	7		V	$I_C = 100 \text{ } \mu\text{A}, I_F = 0$ (Note 2)
Dark Current	I_{CEO}		5	100	nA	$V_{CE} = 5.0 \text{ V}, I_F = 0$ (Note 1)
Ambient Light Leakage Current			2		μA	$V_{CE} = 5.0 \text{ V}, I_F = 0$ (Note 2)
Rise Time	t_r		.36		ms	$V_{CE} = 5 \text{ V}, R_L = 1 \text{ K}\Omega$
Fall Time	t_f		.3		ms	$V_{CE} = 5 \text{ V}, R_L = 1 \text{ K}\Omega$
Turn-on Time	t_{ON}		.15		ms	$I_F = 40 \text{ mA}, \text{FIG 12}$
Turn-off Time	t_{OFF}		.2		ms	$I_F = 40 \text{ mA}, \text{FIG 12}$
DC Current Transfer Ratio	CTR	4	8		%	$I_F = 16 \text{ mA}, V_{CE} = 5 \text{ V}$

ABSOLUTE MAXIMUM RATINGS

Storage Temperature Range. -65°C to +100°C
 Operating Temperature Range. -55°C to +100°C
 Lead Temp. (Soldering, 10sec). 260°C
 Total Power Diss. @ 25°C Free
 Air Temperature 275 mW
 Derate Linearly to 100°C (θ_{JA}) 1.65 mW/°C
 Input to Output Isolation Voltage 1500 VAC

Input Diode
 Forward DC Current 60 mA
 Reverse DC Current 4 mA
 Peak Forward Current
 (1 μs pulse, 300 pps) 3.0 A
 Output Darlington
 Collector-Emitter Voltage (BV_{CEO}) 30 V
 Collector Current 100 mA

TYPICAL ELECTRO-OPTICAL CHARACTERISTIC CURVES
 (25°C Free Air Temperature Unless Otherwise Specified)

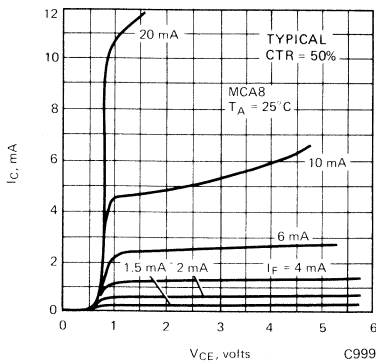


Figure 1 Collector Current vs. Collector Voltage

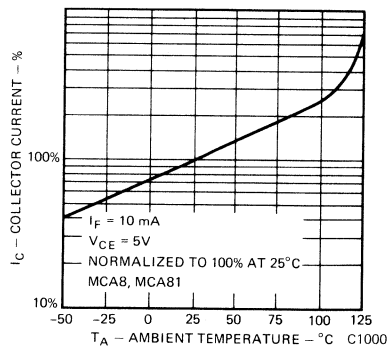


Figure 2 Collector Current vs. Ambient Temperature

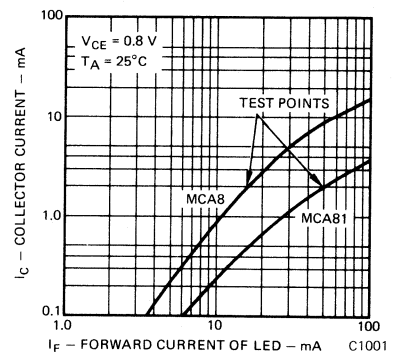


Figure 3 Collector Current vs. LED Current

TYPICAL ELECTRO-OPTICAL CHARACTERISTIC CURVES (CONT.)

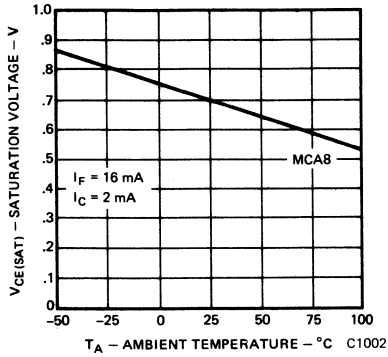


Figure 4 Saturation Voltage vs. Temperature

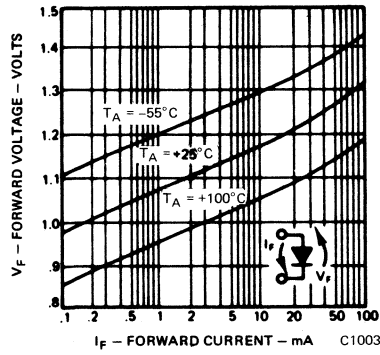


Figure 5 Forward Voltage vs. Forward Current

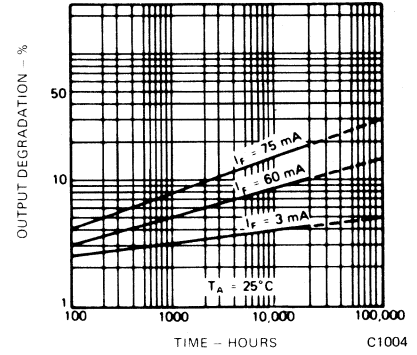


Figure 6 Lifetime vs. Forward Current

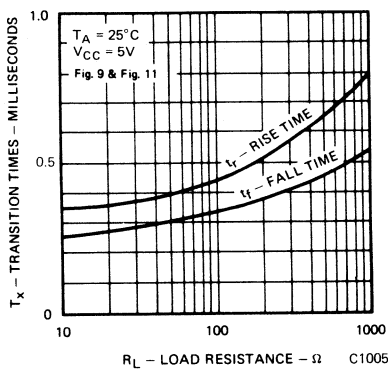


Figure 7 Non-Saturated Rise and Fall Times vs. Load Resistance

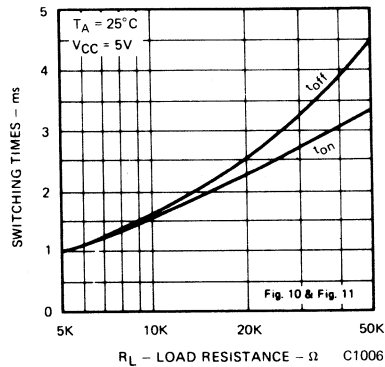


Figure 8 Saturated Switching Times vs. Load Resistance

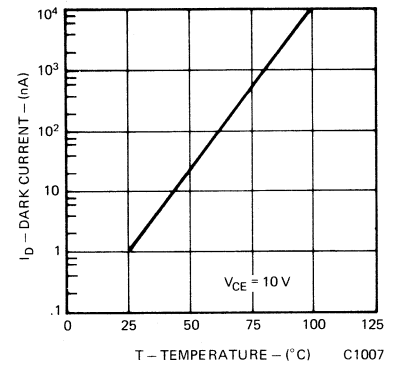


Figure 9 Dark Current vs. Temperature

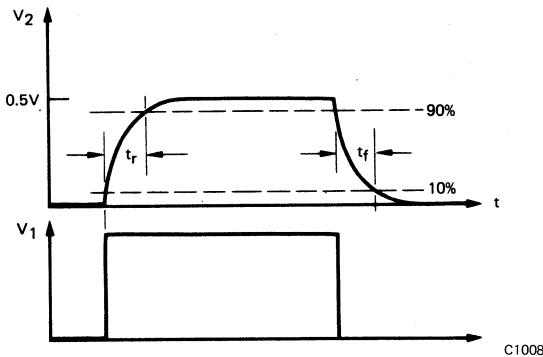


Figure 10 Non-Saturated Switching Waveforms

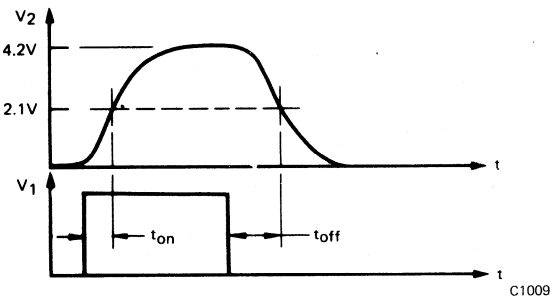


Figure 11 Saturated Switching Waveforms

PW = 10-100 msec
DC = 10%
tr tf = ≤ 10 nsec

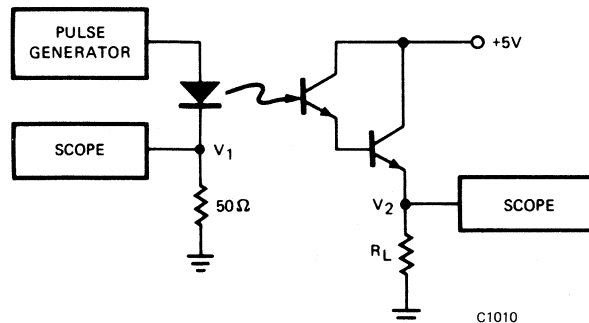
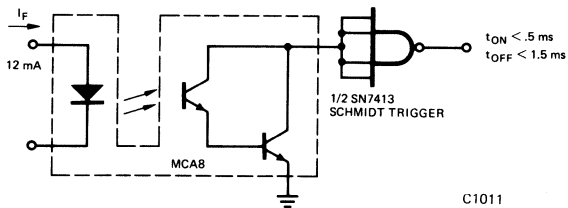
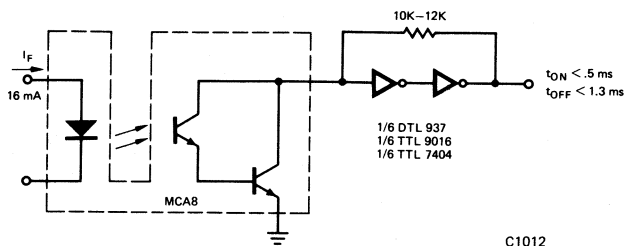


Figure 12 Circuit for Testing Switching Parameters



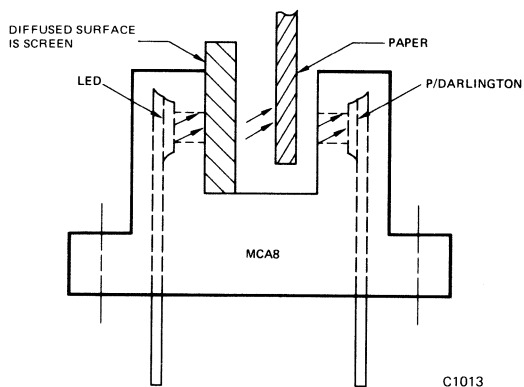
C1011

Figure 12 Driving a TTL Schmidt Trigger



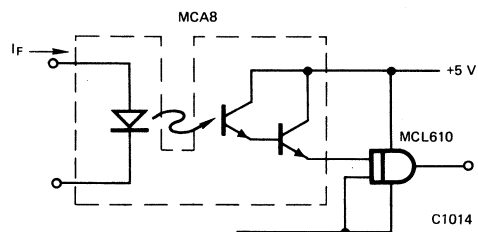
C1012

Figure 13 Driving Two Hex Inverters



C1013

Figure 14 Detecting Paper by using a Lens Screen



C1014

Figure 15 TTL Logic Interface

DETECTING PAPER BY USING A LENS SCREEN

Infrared light tends to go right through paper, making detection very difficult. For instance, one sheet of white 20# bond paper has an ON/OFF ratio of 1.5 to 1. This ratio can be greatly increased by diffusing the light from the LED prior to striking the paper. A piece of paper used as a diffusant increases the ON/OFF ratio to 5:1. For best results, use a plexiglas lens screen, No. LS85PL 1/16, made by Polacoat, 9750 Conklin Road, Cincinnati, Ohio 45242. This screen transmits 90% of the original light, yet increases the ON/OFF ratio to 16:1 for 20# bond paper, and 60:1 for a manila card.

NOTES:

1. Measured with radiation flux intensity of less than $0.1 \mu\text{W}/\text{cm}^2$ (dark condition) over the spectrum from 0.1 micron to 1.5 microns.
2. Measured at typical factory ambient of 150 foot-candles (150 lamberts per square foot).

ELECTRO-OPTICAL CHARACTERISTICS (25°C Free Air Temperature Unless Otherwise Specified)

CHARACTERISTIC	SYMBOL	MIN.	TYP.	MAX.	UNITS	TEST CONDITIONS
INPUT DIODE						
Forward Voltage	V_F		1.30	1.50	V	$I_F = 20 \text{ mA}$
Reverse Breakdown Voltage	BV_R	3.0	20		V	$I_R = 10 \mu\text{A}$
Reverse Leakage Current	I_R		.01	10	μA	$V_R = 3 \text{ V}$
OUTPUT TRANSISTOR—MCT8						
DC Current Transfer Ratio	CTR	.200	1.0		mA	$I_F = 20 \text{ mA}, V_{CE} = 10 \text{ V}$
Saturation Voltage	$V_{CE}(\text{SAT})$		0.2	0.4	V	$I_C = 50 \mu\text{A}, I_F = 20 \text{ mA}$ (Note 1)
Collector Breakdown Voltage	BV_{CEO}	30	55		V	$I_C = 1 \text{ mA}, I_F = 0$ (Note 1)
Emitter Breakdown Voltage	BV_{ECO}	5	7		V	$I_C = 100 \mu\text{A}, I_F = 0$ (Note 2)
Dark Current	I_{CEO}		5	100	nA	$V_{CE} = 10.0 \text{ V}, I_F = 0$ (Note 1)
Ambient Leakage Current			0.35		μA	$V_{CE} = 10.0 \text{ V}, I_F = 0$ (Note 2)
Rise Time	t_r		5		μsec	$V_{CC} = 10 \text{ V}, I_C = 1 \text{ mA}$ $R_L = 100 \Omega$ CIRCUIT 1
Fall Time	t_f		4		μsec	$V_{CC} = 10 \text{ V}, I_C = 1 \text{ mA}$ $R_L = 100 \Omega$ CIRCUIT 1
Turn-on Time (from 5 V to 0.8 V)	t_{ON}		6		μsec	$I_F = 40 \text{ mA}$ CIRCUIT 2 $R_B = 1.2\text{k}\Omega, R_L = 2.4\text{k}\Omega$
Turn-off Time (from SAT. to 2 V)	t_{OFF}		4		μsec	$I_F = 40 \text{ mA}$ CIRCUIT 2 $R_B = 1.2\text{k}\Omega, R_L = 2.4\text{k}\Omega$
OUTPUT TRANSISTOR—MCT81						
DC Current Transfer Ratio	CTR	50	100		μA	$I_F = 20 \text{ mA}, V_{CE} = 10 \text{ V}$
Saturation Voltage	$V_{CE}(\text{SAT})$		0.2	0.4	V	$I_C = 25 \mu\text{A}, I_F = 20 \text{ mA}$ (Note 1)
Collector Breakdown Voltage	BV_{CEO}	30	55		V	$I_C = 1 \text{ mA}, I_F = 0$ (Note 1)
Emitter Breakdown Voltage	BV_{ECO}	5	7		V	$I_C = 100 \mu\text{A}, I_F = 0$ (Note 2)
Dark Current	I_{CEO}		5	100	nA	$V_{CE} = 10.0 \text{ V}, I_F = 0$ (Note 1)
Ambient Light Leakage Current			0.30		μA	$V_{CE} = 10.0 \text{ V}, I_F = 0$ (Note 2)
Rise Time	t_r		3		μsec	$V_{CC} = 10 \text{ V}, I_C = 1 \text{ mA}$ $R_L = 100 \Omega$ CIRCUIT 1
Fall Time	t_f		4		μsec	$V_{CC} = 10 \text{ V}, I_C = 1 \text{ mA}$ $R_L = 100 \Omega$ CIRCUIT 1
Turn-on Time (from 5 V to 0.8 V)	t_{ON}		6		μsec	$I_F = 40 \text{ mA}$ CIRCUIT 2 $R_B = 1.2\text{k}\Omega, R_L = 2.4\text{k}\Omega$
Turn-off Time (from SAT to 2 V)	t_{OFF}		3		μsec	$I_F = 40 \text{ mA}$ CIRCUIT 2 $R_B = 1.2\text{k}\Omega, R_L = 2.4\text{k}\Omega$

ABSOLUTE MAXIMUM RATINGS

Storage Temperature Range -65°C to +100°C
 Operating Temperature Range . . . -55°C to +100°C
 Lead Temp. (Soldering, 10 sec) 260°C
 Total Power Diss. @ 25°C Free
 Air Temperature 275 mW
 Derate Linearly to 100°C (θ_{JA}). 3.7 mW/°C

Input Diode
 Forward DC Current 50 mA
 Reverse DC Current 4 mA
 Peak Forward Current
 (1 μs pulse, 300 pps) 3.0 A
 Output Transistor
 Collector-Emitter Voltage 30 V
 Emitter-Collector Voltage 5 V

TYPICAL ELECTRO-OPTICAL CHARACTERISTIC CURVES
(25°C Free Air Temperature Unless Otherwise Specified)

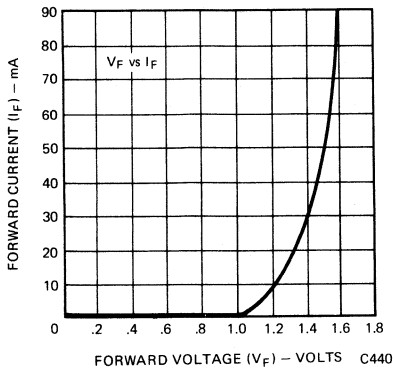


Fig. 1. Forward Voltage vs. Forward Current

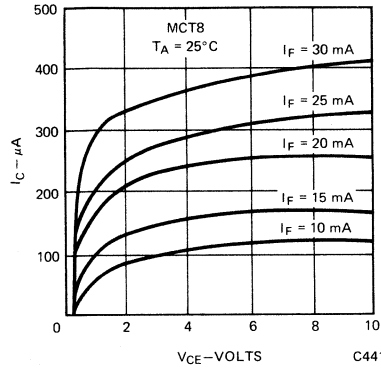


Fig. 2. Collector Current vs. Collector Voltage

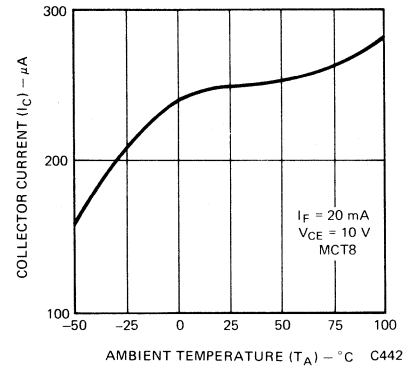


Fig. 3. Collector Current vs. Ambient Temperature

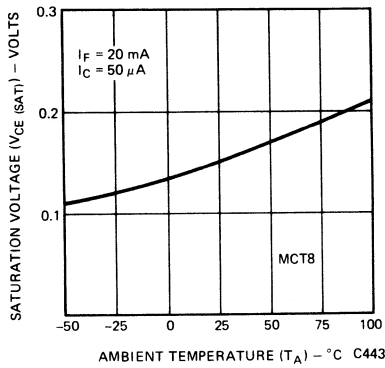


Fig. 4. Saturation Voltage vs. Temperature

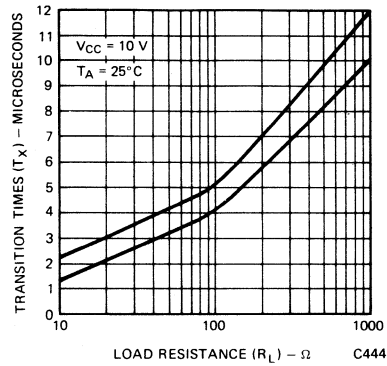


Fig. 5. Non-saturated Rise and Fall Times vs. Load Resistance

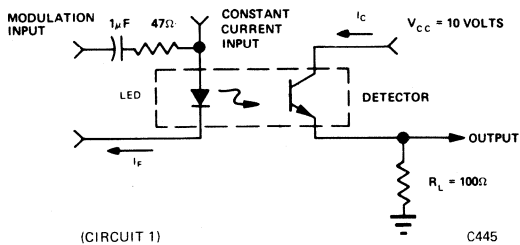


Figure 6.

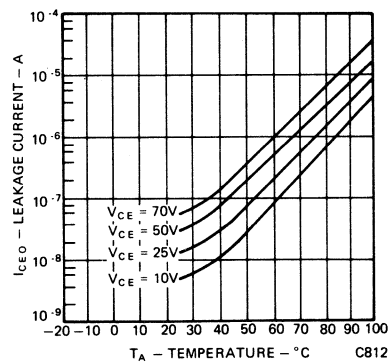


Fig. 7. Dark Current vs. Temperature

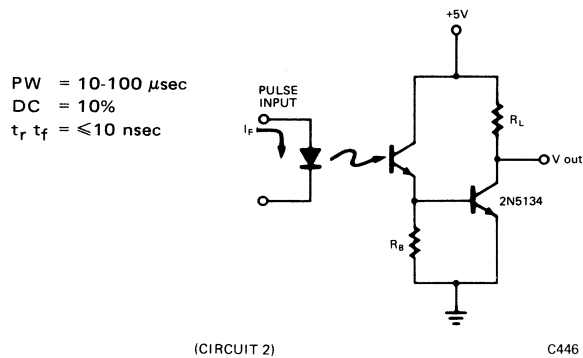
TYPICAL ELECTRO-OPTICAL CHARACTERISTIC CURVES (CONT.)

Figure 7.

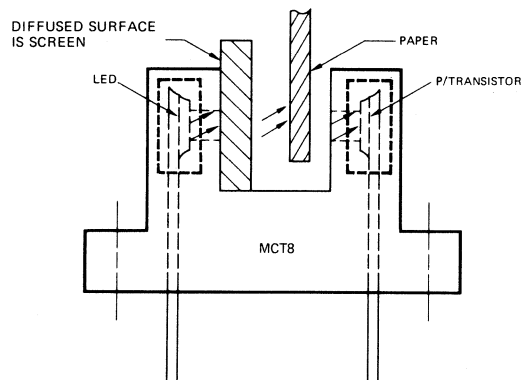


Fig. 8. Detecting Paper by Using a Lens Screen

DETECTING PAPER BY USING A LENS SCREEN

Infrared light tends to go right through paper, making detection very difficult. For instance, one sheet of white 20# bond paper has an ON/OFF ratio of 1.5 to 1. This ratio can be greatly increased by diffusing the light from the LED prior to striking the paper. A piece of paper used as a diffusant increases the ON/OFF ratio to 5:1. For best results, use a plexiglas lens screen, No. LS85PL 1/16, made by Polacoat, 9750 Conklin Road, Cincinnati, Ohio 45242. This screen transmits 90% of the original light, yet increases the ON/OFF ratio to 16:1 for 20# bond paper, and 60:1 for a manila card.

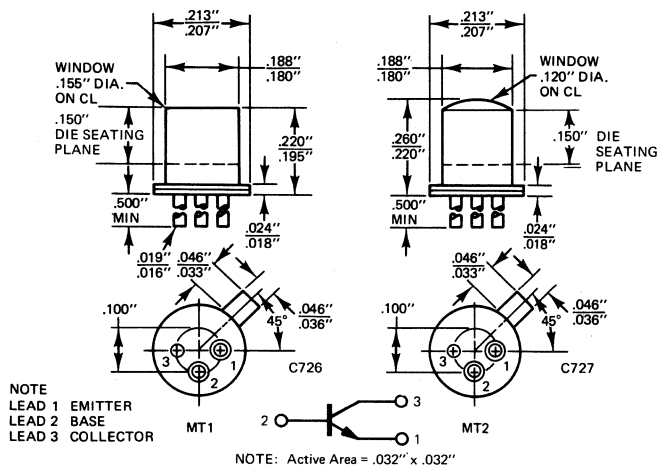
NOTES:

1. Measured with radiation flux intensity of less than $0.1 \mu\text{W}/\text{cm}^2$ (dark condition) over the spectrum from 0.1 micron to 1.5 microns.
2. Measured at typical factory ambient of 150 foot-candles (150 lamberts per square foot).
3. Rise time is the time required for the collector current to increase from 10% of its final value to 90%.
 Fall time is the time required for the collector current to decrease from 90% of its initial value to 10%.

PRODUCT DESCRIPTION

The MT1 and MT2 silicon phototransistors are mounted on a standard TO46 header. The MT1 features a flat window mounted at the top of a protective metal can. The MT2 has a lens in the same position for optical gain of 4.

PACKAGE DIMENSIONS



FEATURES & APPLICATIONS

- Low leakage current - 1 nA
- Wide Spectral Response
- Responsive to GaAs - 1.40 mA/mW/cm²
- Optional flat lens (MT1) or built-in optics (MT2)
- Standard Transistor (Hermetic Seal) package for easy handling and mounting
- Optical switching & encoding
- Intrusion Alarm
- Process Control
- Tape and Card Reader
- Level & Industrial Control
- Optical Character Recognition

ABSOLUTE MAXIMUM RATINGS

Storage and Operating Temperature -55°C to 125°C
 Maximum Lead Solder Time @ 260°C (See Note 1) - 7.0 sec

Power Dissipation @ 25°C Ambient	200 mW
Derate Linearly from 25°C	2.0 mW/°C
Collector-Emitter Breakdown Voltage (BV _{CEO})	30 V
Emitter-Collector Breakdown Voltage (BV _{ECO})	7.0 V
Collector-Base Breakdown Voltage (BV _{CBO})	80 V
Collector Current (I _C)	40 mA

ELECTRO-OPTICAL CHARACTERISTICS

(25°C Free Air Temperature Unless Otherwise Specified)

CHARACTERISTICS & SYMBOLS	MIN.	TYP.	MAX.	UNITS	TEST CONDITIONS
Sensitivity MT1 (see note 3) (S _{CEO})	200	560		μA/mW/cm ²	λ=0.9 microns, V _{CE} =5.0 V
Sensitivity MT2 (see note 3) (S _{CEO})	500	1400		μA/mW/cm ²	λ=0.9 microns, V _{CE} =5.0 V
Sensitivity MT1 (see note 4) (S _{CEO})	80	260		μA/mW/cm ²	2875° K, V _{CE} =5.0 V
Sensitivity MT2 (see note 4) (S _{CEO})	200	650		μA/mW/cm ²	2875° K, V _{CE} =5.0 V
Sensitivity MT1 (see note 3) (S _{CBO})	1.4	2.5		μA/mW/cm ²	λ=0.9 microns, V _{CE} =5.0 V
Sensitivity MT2 (see note 3) (S _{CBO})	3.5	6.2		μA/mW/cm ²	λ=0.9 microns, V _{CB} =5.0 V
Sensitivity MT1 (see note 4) (S _{CBO})	0.6	1.0		μA/mW/cm ²	2875° K, V _{CB} =5.0 V
Sensitivity MT2 (see note 4) (S _{CBO})	1.5	2.5		μA/mW/cm ²	2875° K, V _{CB} =5.0 V
Collector-emitter saturation voltage (V _{CE(sat)})	0.2	0.5		V	I _C =2.0 mA, H=10mW/cm ²
Light current rise time (see figure 8) (t _r)		2.0		μs	V _{CC} =5.0 V, I _C =2.0 mA, R _L =100Ω
Light current fall time (see figure 8) (t _f)		2.0		μs	V _{CC} =5.0 V, I _C =2.0 mA, R _L =100Ω
Delay time (see figure 8) (t _d)		1.2		μs	V _{CC} =5.0 V, I _C =2.0 mA, R _L =100Ω
Frequency response		300		kHz	V _{CC} =5.0 V, I _C =2.0 mA, R _L =100Ω

ELECTRICAL CHARACTERISTICS (25°C Free Air Temperature Unless Otherwise Specified)

CHARACTERISTICS	SYMBOLS	MIN.	TYP.	MAX.	UNITS	TEST CONDITIONS
Collector dark current (see note 2)	I_{CEO}		1	20	nA	$V_{CE}=5.0\text{ V}$
Collector dark current (see note 2)	I_{CBO}		0.15	10	nA	$V_{CB}=5.0\text{ V}$
Collector base breakdown voltage (see note 2)	BV_{CBO}	80	140		V	$I_C=100\ \mu\text{A}$
Collector emitter breakdown voltage (see note 2)	BV_{CEO}	30	65		V	$I_C=100\ \mu\text{A}$
Emitter collector breakdown voltage (see note 2)	BV_{ECO}	7	12		V	$I_E=100\ \mu\text{A}$

TYPICAL ELECTRO-OPTICAL CHARACTERISTIC CURVES

(25°C Free Air Temperature Unless Otherwise Specified)

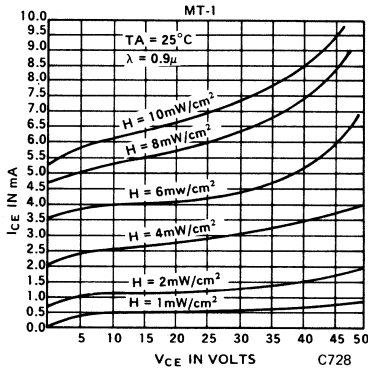


Figure 1 Collector-Emitter Characteristics

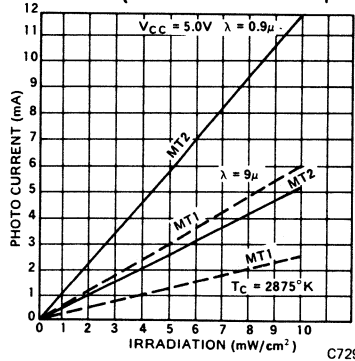


Figure 2 Photo Current vs. Irradiation

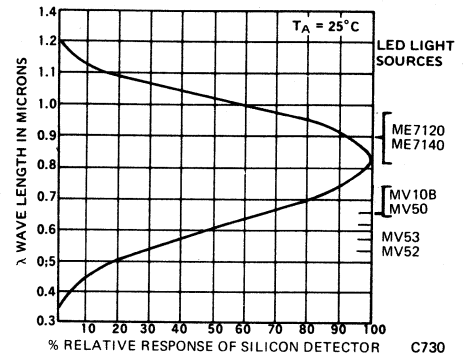


Figure 3 Spectral Response

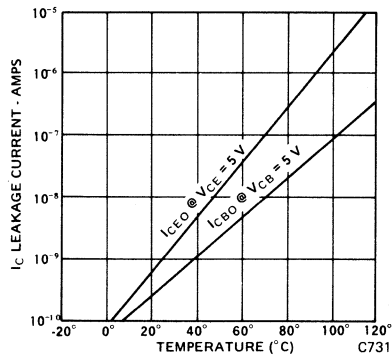


Figure 4 Leakage Current vs. Temperature

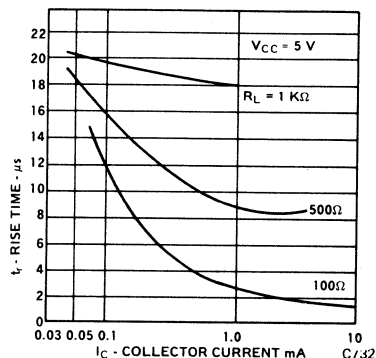


Figure 5 Rise Time vs. Collector Current

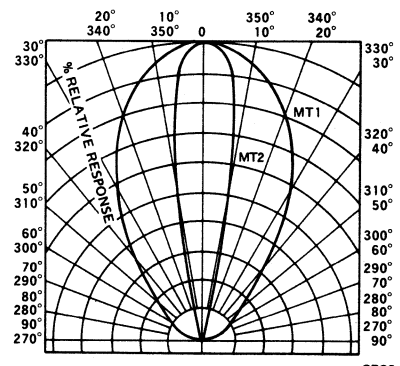


Figure 6 Angular Response

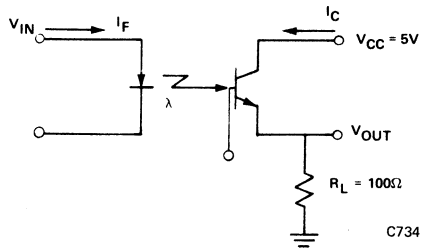


Fig. 7 Circuit Used to Obtain Switching Time vs. Collector Current Plot

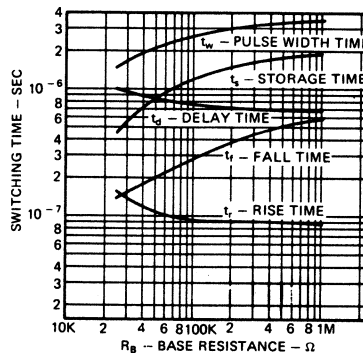
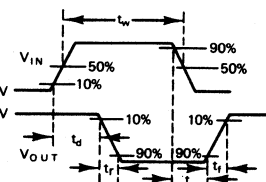


Fig. 8 Switching Time vs. Base Resistance



C735

NOTES

1. The leads of the device were immersed in molten solder, heated to a temperature of 260°C, to a point 1/16-inch from the body of the device per MIL-S-750.
2. Measured under dark conditions $H \leq 1.0\ \mu\text{W}/\text{cm}^2$.
3. Measured with a GaAs light source at 0.9 microns with a radiation flux density of $3\ \text{mW}/\text{cm}^2$.
4. Measured with a tungsten filament lamp operated at a color temperature of 2875°K with a radiation flux density of $5\ \text{mW}/\text{cm}^2$.

Monsanto

PRELIMINARY DATA SHEET

MT8020

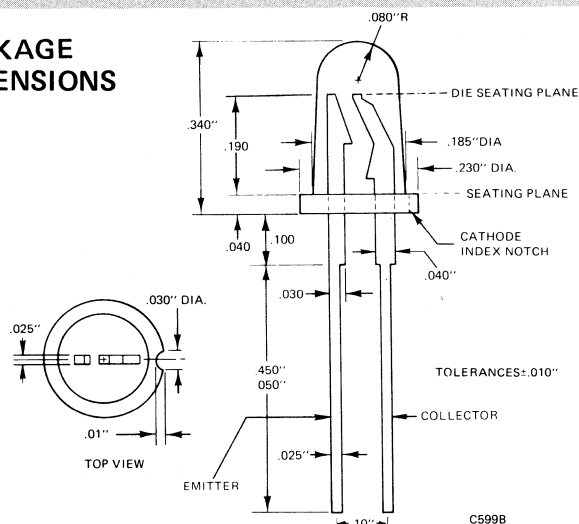
SILICON PHOTOTRANSISTOR

APPLICATIONS

When used as an emitter-detector pair the MT8020 and the ME7121 or ME7124 are suitable for the following applications:

- Optical shaft position and velocity monitor using a digitally encoded disc mounted on a shaft.
- Optical sensing of holes in paper, paper tape, IBM card or magnetic tape.
- Optical sensing of marks on paper, paper tape, or IBM card.
- End of tape sensor using a transparent section of tape, a reflective strip on the tape, or a hole in the tape.
- End of film sensor for films not affected by infra-red light.
- Limit switch for mechanical travel such as cam switches, pressure switches, machine tool limit switches, foot pedal switches, safety interlock switches.
- Edge sensor for sheet materials such as paper, plastic film, fabric, foil, newsprint, belt sanders, reproduction paper.
- Fiber continuity monitor for fibers such as yarn, wire, thread.
- Fluid volume monitor by sensing turbine vanes passing through the slot.
- Liquid level detector of an opaque liquid.

PACKAGE DIMENSIONS



PRODUCT DESCRIPTION

The MT8020 is an NPN silicon planar phototransistor in a clear epoxy T-1 3/4 lamp package. The infrared emitter mates for the MT8020 are the ME7121 and the ME7124.

ELECTRO-OPTICAL CHARACTERISTICS (25°C Free Air Temperature Unless Otherwise Specified)

CHARACTERISTIC	SYMBOL	MIN.	TYP.	MAX.	UNIT	TEST CONDITIONS
Sensitivity (light current)	S_{ceo}	125	350	—	$\mu\text{A}/\text{mw}/\text{cm}^2$	$V_{ce} = 5\text{V}$ source = GaAs (note 4)
Sensitivity (light current)	S_{ceo}	50	140	—	$\mu\text{A}/\text{mw}/\text{cm}^2$	$V_{ce} = 5\text{V}$ source = tungsten (note 3)
Collector emitter breakdown voltage	BV_{ceo}	30	65	—	Volts	$I_c = 100 \mu\text{A}$ (note 2)
Collector dark current	I_{ceo}	—	1.5	50	nA	$V_{ce} = 10\text{V}$ (note 2)
Emitter Collector breakdown voltage	BV_{eco}	7	12	—	Volts	$I_e = 100\mu\text{A}$
Collector emitter saturation voltage	$V_{ce}(\text{SAT})$	—	0.2	0.4	Volts	$I_c = 1.6\text{mA}$ $H = 10\text{mw}/\text{cm}^2$ source = GaAs (note 4)
Switching Speed	t_{on}	—	2.5	—	μsec	$V_{cc} = 5.0\text{V}$ $I_c = 1.6\text{mA}$
	t_{off}	—	1.8	—	μsec	$R_L = 100\Omega$ (figure 7)
Current transfer ratio -ME7124	CTR	—	2.0	—	%	$V_{ce} = 5\text{V}$, when coupled to ME7124 at $I_f = 20\text{mA}$. MPT8020 to ME7124 distance is .200"
Current transfer ratio -ME7121	CTR	—	0.5	—	%	$V_{ce} = 5\text{V}$, when coupled to ME7121 at $I_f = 20\text{mA}$. MPT8020 to ME7121 distance is .200"

ABSOLUTE MAXIMUM RATINGS

Storage and Operating Temperature -55°C to 100°C

Power Dissipation @ 25°C Ambient200 mW

Derate Linearly above 25°C Ambient 2.67 mW/ $^{\circ}\text{C}$

Collector-Emitter Breakdown Voltage (BV_{CEO})30 V

Maximum Lead Solder Time @ 230°C (See Note 1) -5.0 sec

Emitter-Collector Breakdown Voltage (BV_{ECO}) 7.0 V

Collector Current (I_C)40 mA

TYPICAL ELECTRO-OPTICAL CHARACTERISTIC CURVES

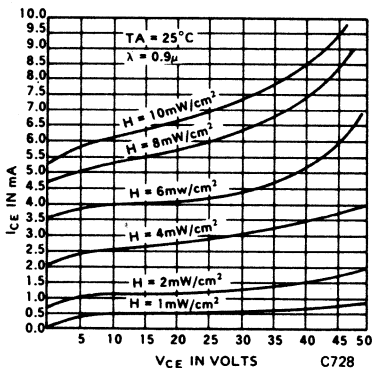


Fig. 1. Collector-Emitter Characteristics

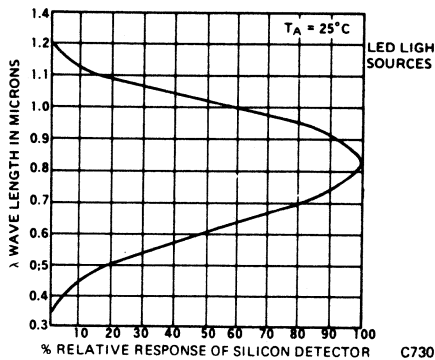


Fig. 2. Spectral Response

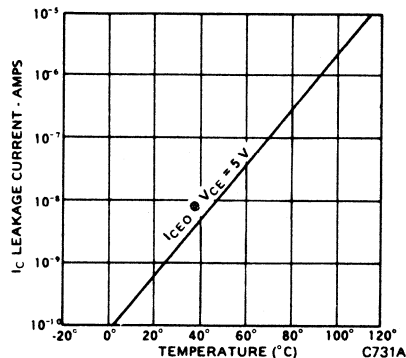


Fig. 3. Leakage Current vs. Temperature

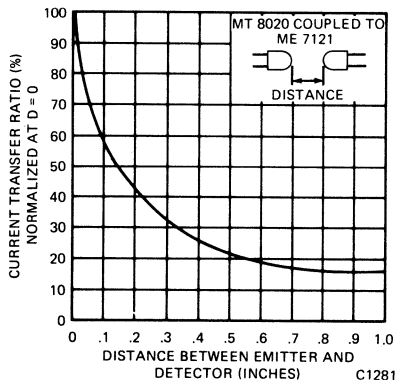


Fig. 4. Normalized Current Transfer Ratio vs. Distance Between Emitter and Detector MT8020 and ME7121.

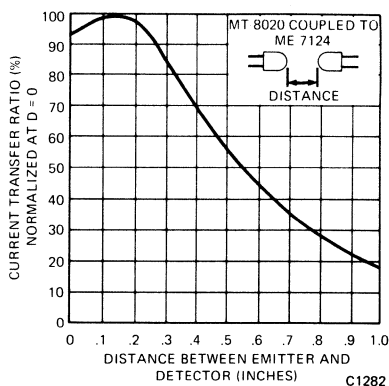


Fig. 5. Normalized Current Transfer Ratio vs. Distance Between Emitter and Detector MT8020 and ME7124.

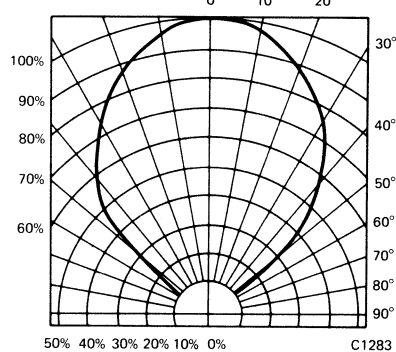


Fig. 6. Angular Response

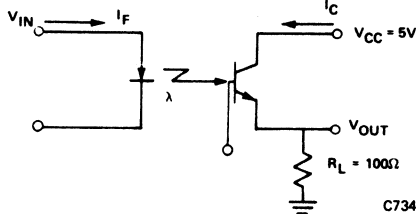


Fig. 7. Circuit Used to Obtain Switching Time Values Light Source is ME7121 or ME7124

NOTES

1. The leads of the device were immersed in molten solder, heated to a temperature of 230°C , to a point 1/16-inch from the body of the device per MIL-S-750.
2. Measured under dark conditions $H \leq 1.0 \mu\text{W}/\text{cm}^2$.
3. Radiation source is an unfiltered tungsten filament bulb at 2875°K color temperature.
4. Radiation source is a GaAs infrared emitting diode such as a ME7121 or ME7124 at $\lambda = 0.94$ microns.

Monsanto

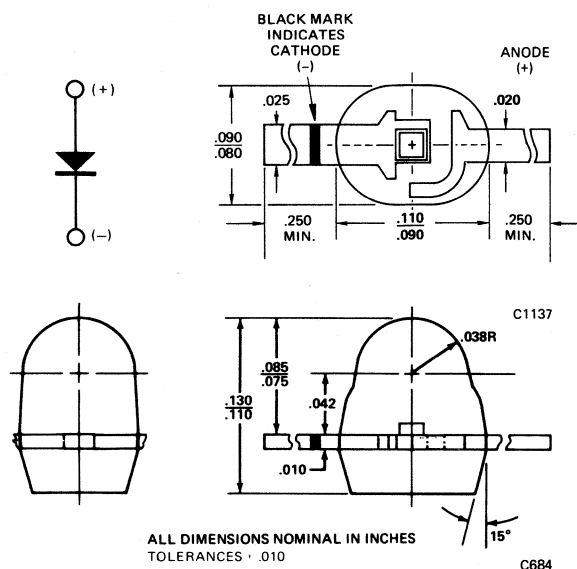
ME60

INFRARED EMITTER

PRODUCT DESCRIPTION

The ME60 is a diffused planar gallium arsenide infrared diode. The lead-frame construction is encapsulated in an epoxy case and lens.

PACKAGE DIMENSIONS



FEATURES

The ME60 is intended for high volume infrared source application where low cost, high reliability and high density packaging are required.

- Low Cost
- Compatible with integrated circuits
- Long life, rugged
- Small Size
- Easily assembled in linear arrays
- Card & tape reader sources
- High on-axis power

ABSOLUTE MAXIMUM RATINGS

Power dissipation @ 25°C ambient	75 mW
Derate linearly from 25°C	1.0mW/°C
Storage & operating temperature	-55°C to 100°C
Lead solder time @ 230°C (See Note 1)	5 sec
Continuous forward current	50 mA
Peak forward current (1 μsec pulse width, 0.3% duty cycle)	1.0 A
Reverse voltage	3.0 V
Reverse current	10 μA

ELECTRO-OPTICAL CHARACTERISTICS

(25°C Free Air Temperature Unless Otherwise Specified)

CHARACTERISTICS	MIN.	TYP.	MAX.	UNITS	TEST CONDITIONS
Total external radiated power (see note 2)	400	550		μW	I _F = 50 mA
On-axis irradiance		250		μW/cm ²	I _F = 50 mA, d = 1 cm
Peak emission wave length		900		nm	
Spectral line half-width		50		nm	
Forward voltage		1.3	1.5	V	I _F = 50 mA
Reverse current		5		nA	V _R = 3.0 volts
Light turn-on and turn-off		10		ns	
Capacitance		80		pF	V=0
Reverse breakdown voltage	3	5		V	I _R = 10 μA
Forward voltage temperature coefficient		-1.05		mV/°C	I _F = 10 mA

TYPICAL ELECTRO-OPTICAL CHARACTERISTIC CURVES

(25°C Free Air Temperature Unless Otherwise Specified)

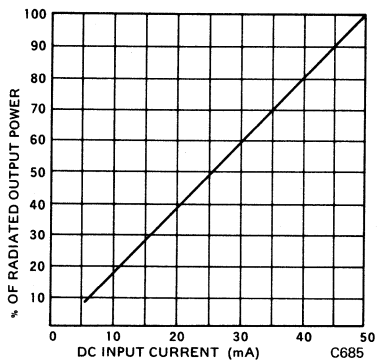


Fig. 1. Input Current vs. Output Power

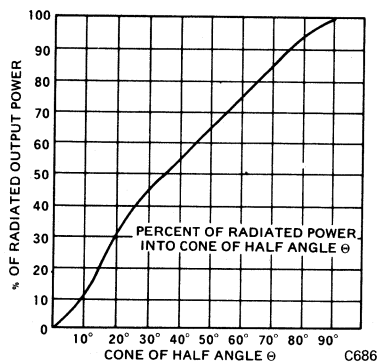


Fig. 2. Percent of Radiated Power into Cone of Half Angle

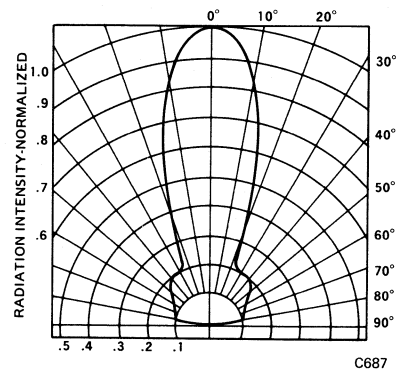


Fig. 3. Spatial Distribution (Note 3)

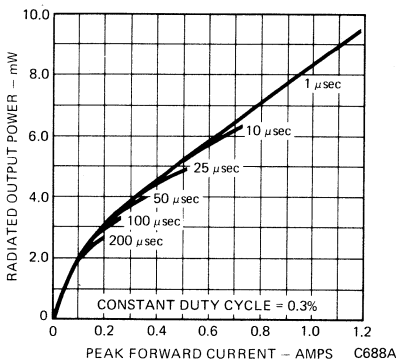


Fig. 4. Radiated Output Power vs. Peak Forward Current

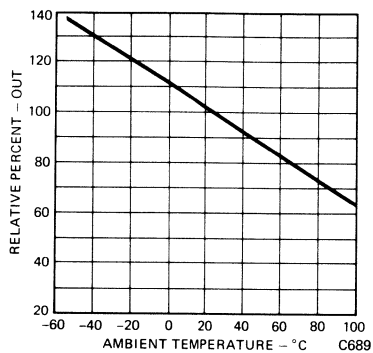


Fig. 5. % Relative Output vs. Temperature

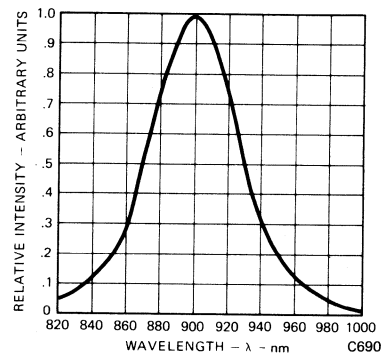


Fig. 6. Spectral Distribution

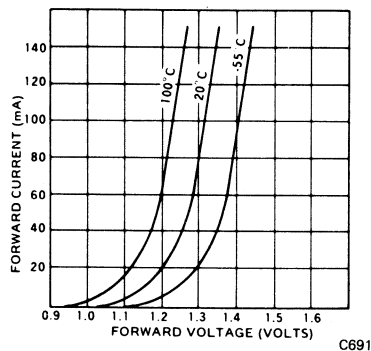


Fig. 7. Forward Current vs. Forward Voltage

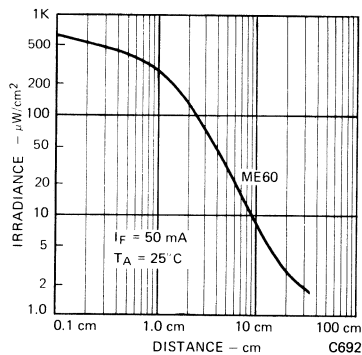


Fig. 8. On-Axis Irradiance vs. Distance (Note 4)

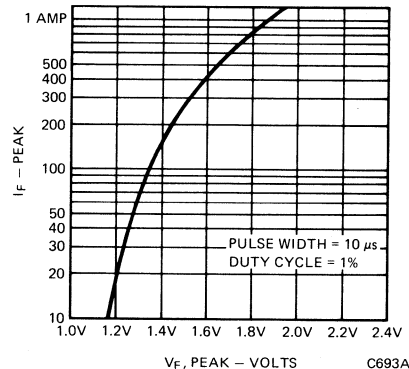


Fig. 9. V_F vs. I_F (to 4 A) Pulsed

NOTES

1. The leads of the device were immersed in molten solder, heated to a temperature of 230°C, to a point 1/16 inch from the body of the device per MIL-S-750.
2. The total external radiated power output measurements are made with a Centralab 110C solar cell terminated into a 100Ω impedance.
3. The axis of spatial distribution are typically within a 10° cone with reference to the central axis of the device.
4. Distance measurements taken from top of lens.

Monsanto

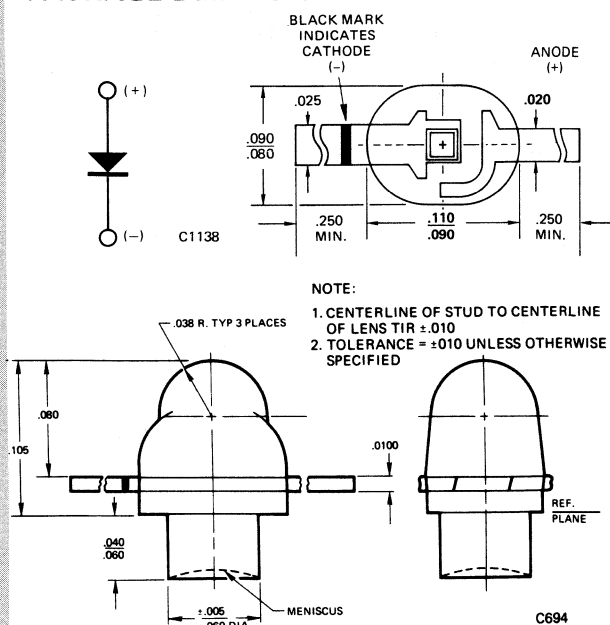
ME61

INFRARED EMITTER

PRODUCT DESCRIPTION

The ME61 is a diffused planar gallium arsenide infrared diode. The lead-frame construction is encapsulated in an epoxy case and lens and provides an alignment stud as an integral part of the package.

PACKAGE DIMENSIONS



FEATURES

The ME61 is intended for high volume infrared source application where low cost, high reliability and high density packaging are required.

- Stud base for precise alignment
- Low Cost
- Compatible with integrated circuits
- Long life, rugged
- Small Size
- Easily assembled in linear arrays
- Card & tape reader sources
- High on-axis power

ABSOLUTE MAXIMUM RATINGS

Power dissipation @ 25°C ambient	75 mW
Derate linearly from 25°C	1.0mW/°C
Storage & operating temperature	-55°C to 100°C
Lead solder time @ 230°C (see Note 1)	5 sec
Continuous forward current	50 mA
Peak forward current (1 μ sec pulse width, 0.3% duty cycle)	1.0 A
Reverse voltage	3.0 V
Reverse current	10 μ A

ELECTRO-OPTICAL CHARACTERISTICS (25°C Free Air Temperature Unless Otherwise Specified)

CHARACTERISTICS	MIN.	TYP.	MAX.	UNITS	TEST
					CHARACTERISTICS
Total external radiated power (see note 2)	400	550		μ W	$I_F = 50$ mA
On-axis irradiance		250		μ W/cm ²	$I_F = 50$ mA, d = 1 cm
Zone 1 power (see Fig. 7)	45			μ W	$I_F = 50$ mA
Peak emission wavelength		900		nm	
Spectral line half-width		50		nm	
Forward voltage		1.3	1.5	V	$I_F = 50$ mA
Reverse current		5		nA	$V_R = 3.0$ volts
Light turn-on and turn-off		10		ns	
Capacitance		80		pF	V = 0
Reverse breakdown voltage	3	5		V	$I_R = 10$ μ A
Forward voltage temperature coefficient		-1.05		mV/°C	$I_F = 10$ mA

TYPICAL ELECTRO-OPTICAL CHARACTERISTIC CURVES

(25°C Free Air Temperature Unless Otherwise Specified)

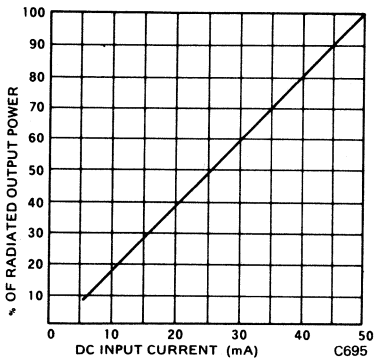


Fig. 1. Input Current vs. Output Power

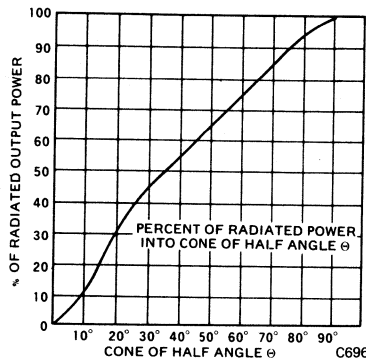


Fig. 2. Percent of Radiated Power into Cone of Half Angle

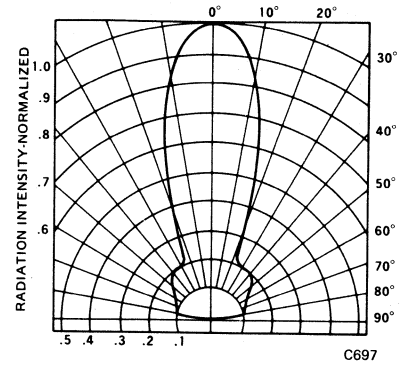


Fig. 3. Spatial Distribution (Note 3)

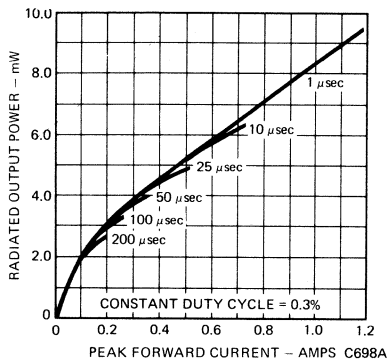


Fig. 4. Radiated Output Power vs. Peak Forward Current

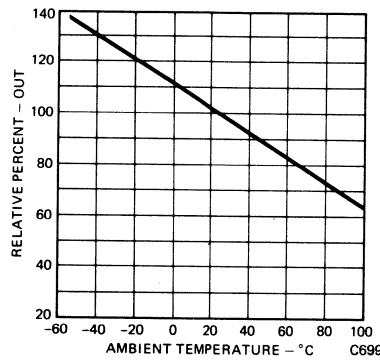


Fig. 5. % Relative Output vs. Temperature

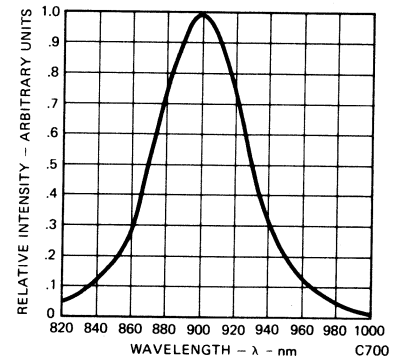


Fig. 6. Spectral Distribution

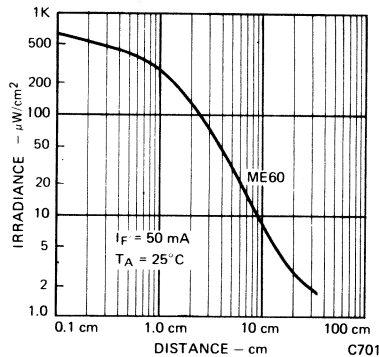


Fig. 7. On-Axis Irradiance vs. Distance

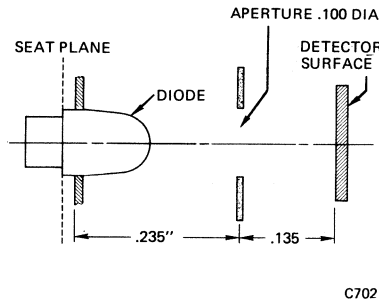


Fig. 8. Zone 1 Measurement

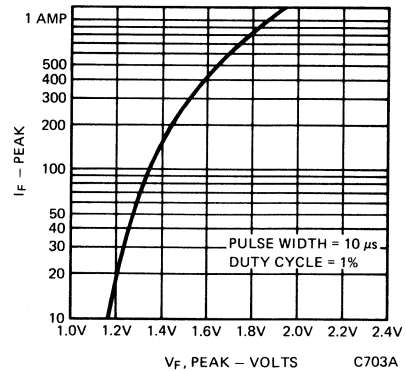


Fig. 9. V_F vs. I_F (to 4A) Pulsed

NOTES

1. The leads of the device were immersed in molten solder, heated to a temperature of 230°C, to a point 1/16 inch from the body of the device per MIL-S-750.
2. The total external radiated power output measurements are made with a Centralab 110C solar cell terminated into a 100Ω impedance.
3. The axis of spatial distribution are typically within a 10° cone with reference to the central axis of the device.

Monsanto

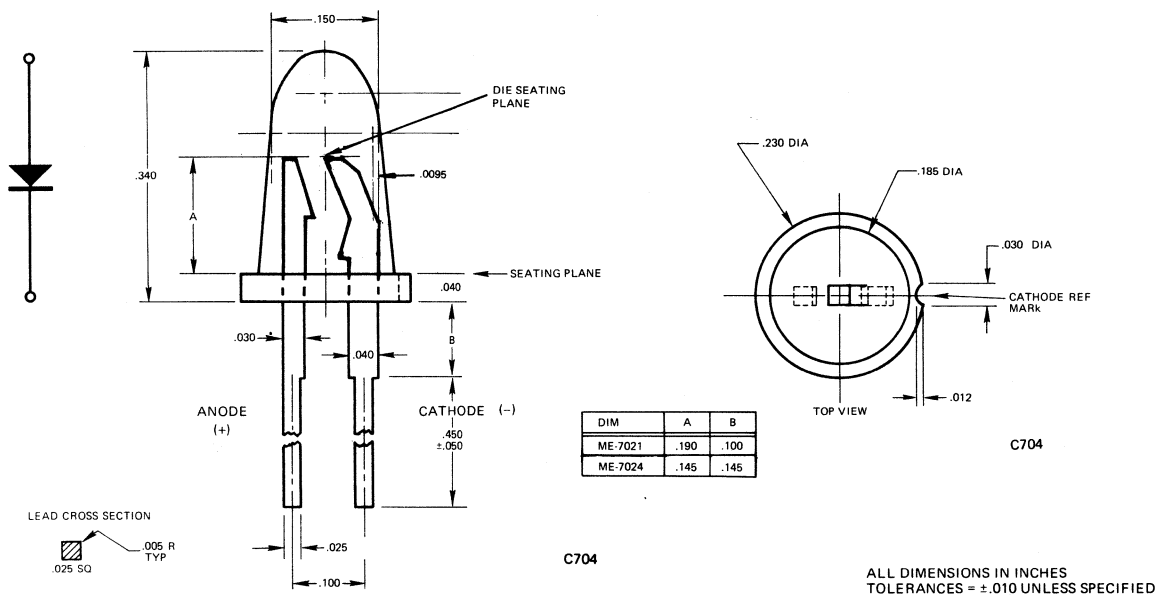
ME7021 ME7024

INFRARED EMITTERS

PRODUCT DESCRIPTION

This family of IR Emitters is designed to accommodate all needs of the emitter detector relationship. Products range from a wide angle power spread for non-critical detector location to sharp-angle concentration of power for detectors located a significant distance from the emitter. The devices can be mounted with a plastic pop-in, furnished upon request.

PACKAGE DIMENSIONS



ELECTRO-OPTICAL CHARACTERISTICS

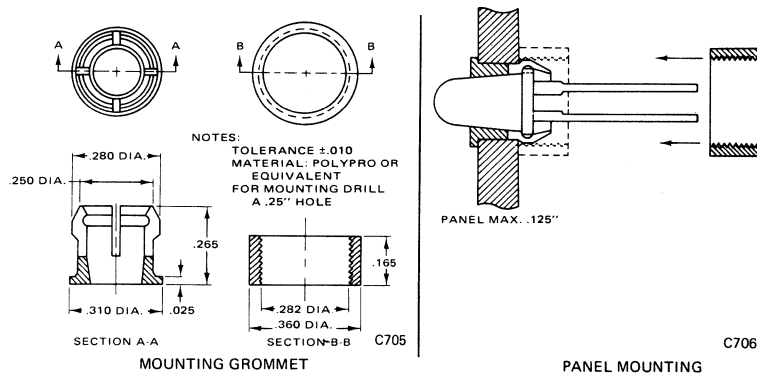
	TYPICAL HALF ANGLE (DEGREES)	TYPICAL ON AXIS INTENSITY (MW/STR.) @ 50 mA	
ME7021	15°	3.6	} into cone @ 1/2 power points @ I _F = 50 mA ROP = 1 mW
ME7024	4°	81.2	

	MIN.	TYP.	MAX.	UNITS	TEST CONDITION
Total External Output Power (Note 2)	.5	1.0		mW	I _F = 50 mA
Peak Emission Wave Length		900		nm	I _F = 50 mA
Spectral Line Half Width		50		nm	I _F = 50 mA
Forward Voltage		1.3	1.5	V	I _F = 50 mA
Reverse Breakdown Voltage	5.0	8.0		V	I _R = 100 μA
Capacitance		105		pF	V = 0, f = 1 MHz
Light Turn On & Turn Off Time		100		nsec	50 Ω Load
Dynamic Resistance (R _D)		1.6		Ω	T _F = 100 mA

ABSOLUTE MAXIMUM RATINGS

Power dissipation @ 25°C ambient	150 mW
Derate linearly from 50°C	2.8 mW/°C
Storage & operating temperature	-55° to 100°C
Lead solder time @ 230°C (Note 3)	5 sec
Continuous forward current	100 mA
Reverse voltage	5.0 V
Peak forward current (PW - 1.0 μsec, Duty Cycle = 0.3%)	1.0 A

PANEL MOUNTING TECHNIQUES



TYPICAL ELECTRO-OPTICAL CHARACTERISTIC CURVES

(25°C Free air temperature unless otherwise specified)

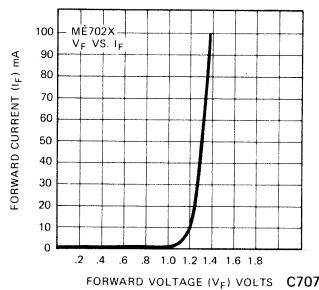


Fig. 1. I_F vs. V_F

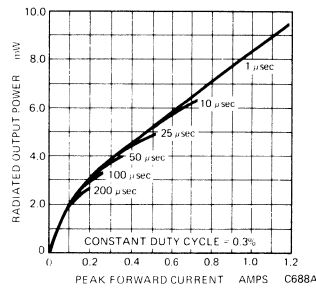


Fig. 2. ROP vs I_F Peak

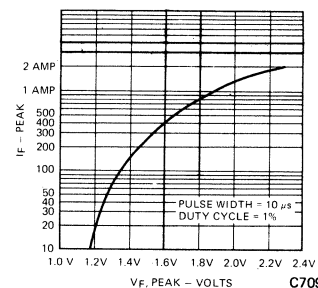


Fig. 3. I_F Peak Pulse Mode Characteristics

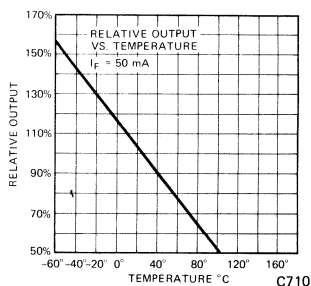


Fig. 4. ROP vs. Temperature
(Note 1)

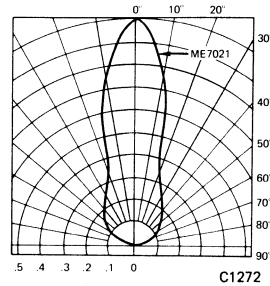


Fig. 5. Spatial Distribution
(ME7021)

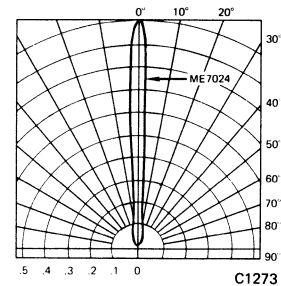


Fig. 6. Spatial Distribution
(ME7024)

NOTES

- The curves in figure 3 are normalized to the power output at 25°C to indicate the relative efficiency over the operating temperature range.
- The total external radiated power output measurements are made with a Centralab 110C solar cell terminated into a 100Ω impedance.
- The leads of the ME7021 and ME7024 were immersed in molten solder, heated to 230°C, to a point 1/16 inch from the body of the device, per MIL-S-750.

Monsanto

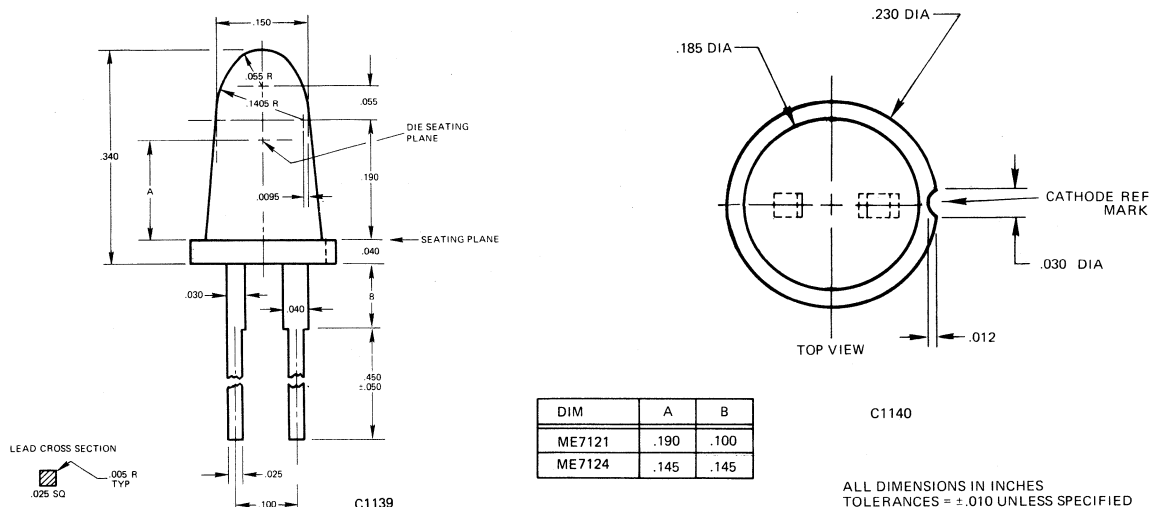
ME7121 ME7124

HIGH POWER INFRARED EMITTERS

PRODUCT DESCRIPTION

This family of high power liquid phase epitaxial IR Emitters is designed to accommodate all needs of the emitter detector relationship. Products range from a wide angle power spread for non-critical detector location to sharp-angle concentration of power for detectors located a significant distance from the emitter. The devices can be mounted with a plastic pop-in, furnished upon request.

PACKAGE DIMENSIONS



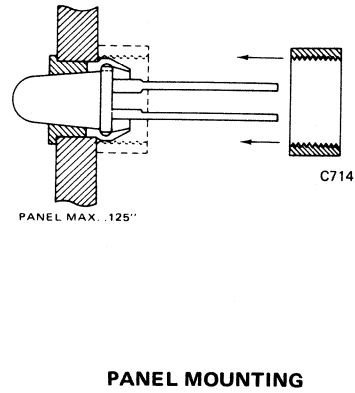
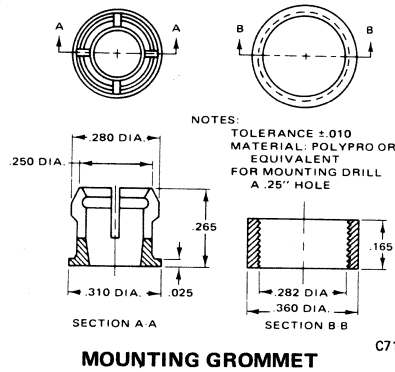
ABSOLUTE MAXIMUM RATINGS

Power dissipation @ 25°C ambient	150 mW
Derate linearly from 50°C	2.8 mW/°C
Storage & operating temperature	-55° to 100°C
Lead solder time @ 230°C (Note 3)	5 sec
Continuous forward current	100 mA
Reverse voltage	3.0 V
Peak forward current (PW = 1.0 μsec, Duty Cycle = 0.3%)	1.0 A

ELECTRO-OPTICAL CHARACTERISTICS

	TYPICAL HALF ANGLE (DEGREES)	TYPICAL ON AXIS INTENSITY (MW/STR.) @ 50 mA			
ME7121	17°	10.8	} into cone @ 1/2 power points @ I _F = 50 mA ROP = 3 mW		
ME7124	6°	243.6			
	MIN.	TYP.	MAX.	UNITS	TEST CONDITIONS
Total External Output Power (Note 2)	1.0	3.0		mW	I _F = 50 mA
Peak Emission Wavelength		940		nm	I _F = 50 mA
Spectral Line Half Width		50		nm	I _F = 50 mA
Forward Voltage		1.4	1.8	V	I _F = 50 mA
Light Turn On & Turn Off Time		500		nsec	50 Ω Load
Reverse Current		10		μA	V _R = 3.0 V

PANEL MOUNTING TECHNIQUES



TYPICAL ELECTRO-OPTICAL CHARACTERISTIC CURVES
(25°C Free air temperature unless otherwise specified.)

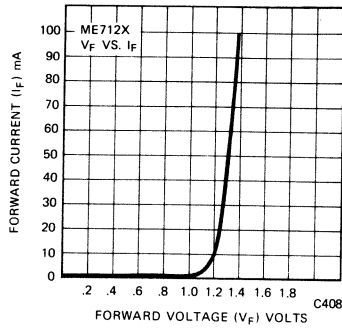


Fig. 1. I_F vs. V_F

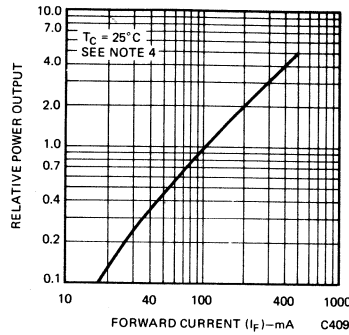


Fig. 2. ROP vs. I_F Peak

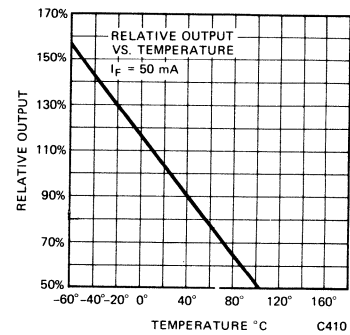


Fig. 3. ROP vs. Temperature (Note 1)

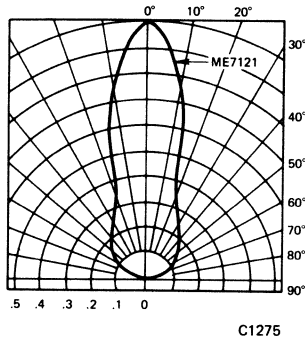


Fig. 4. Spatial Distribution (ME7121)

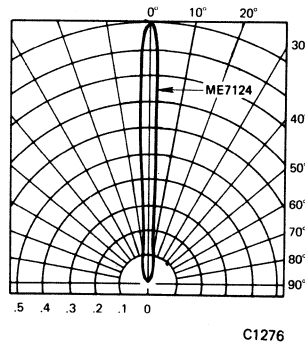


Fig. 5. Spatial Distribution (ME7124)

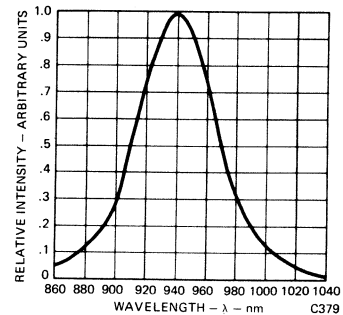


Fig. 6. Spectral Distribution

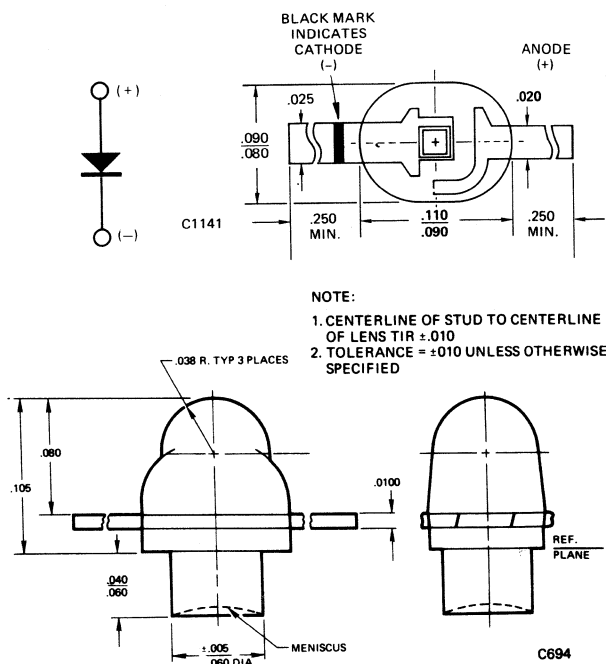
NOTES

1. The curves in figure 3 are normalized to the power output at 25°C to indicate the relative efficiency over the operating temperature range.
2. The total external radiated power output measurements are made with a Centralab 110C solar cell terminated into a 100Ω impedance.
3. The leads of the ME7121 and ME7124 were immersed in molten solder, heated to 230°C, to a point 1/16 inch from the body of the device, per MIL-S-750.
4. This parameter is measured using pulse techniques $tw = 40 \mu\text{sec}$ duty cycle $\leq 10\%$.

PRODUCT DESCRIPTION

The ME7161 is a liquid phase epitaxial gallium arsenide infrared diode. The lead-frame construction is encapsulated in an epoxy case and lens.

PACKAGE DIMENSIONS



FEATURES

The ME7161 is intended for high volume infrared source application where low cost, high reliability and high density packaging are required.

- Low cost
- Compatible with integrated circuits
- Long life, rugged
- Small size
- Easily assembled in linear arrays
- Card & tape reader sources
- High on-axis power

ABSOLUTE MAXIMUM RATINGS

Power dissipation @ 25°C ambient	75 mW
Derate linearly from 25°C	1.0 mW/°C
Storage & operating temperature	-55°C to 100°C
Lead solder time @ 230°C (See Note 1)	5 sec
Continuous forward current	50 mA
Peak forward current (1 μsec pulse width, 0.3% duty cycle)	1.0 A
Reverse voltage	3.0 V

ELECTRO-OPTICAL CHARACTERISTICS (25°C Free Air Temperature Unless Otherwise Specified)

CHARACTERISTICS	MIN.	TYP.	MAX.	UNITS	TEST CONDITIONS
Total external radiated power (see Note 2)	0.8	3.0		mW	I _F = 50 mA
Peak emission wave length		940		nm	I _F = 50 mA
Spectral line half-width		50		nm	I _F = 50 mA
Forward voltage		1.3	1.8	V	I _F = 50 mA
Reverse current		10		μA	V _R = 3.0 V
Light turn-on and turn-off		500		ns	50Ω Load
Capacitance		80		pF	V = 0
Forward voltage temperature coefficient		-1.05		mV/°C	I _F = 10 mA

TYPICAL ELECTRO-OPTICAL CHARACTERISTIC CURVES

(25°C Free Air Temperature Unless Otherwise Specified)

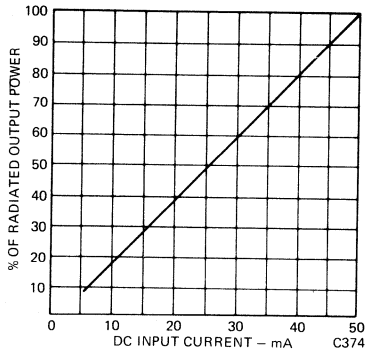


Fig. 1. Input Current vs. Output Power

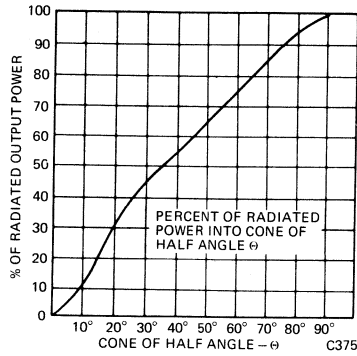


Fig. 2. Percent of Radiated Power Into Cone of Half Angle

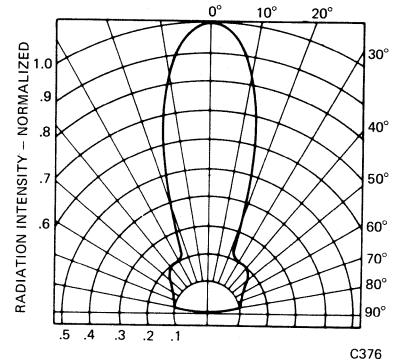


Fig. 3. Spatial Distribution (Note 3)

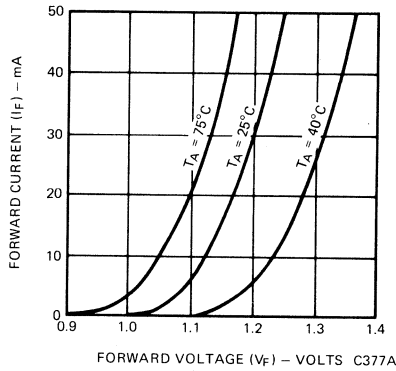


Fig. 4. Forward Current vs. Forward Voltage

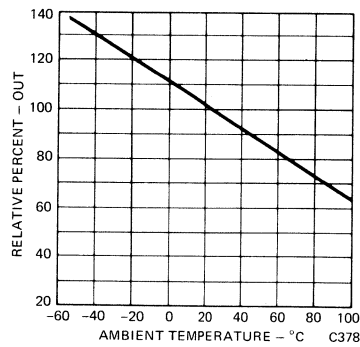


Fig. 5. % Relative Output vs. Temperature

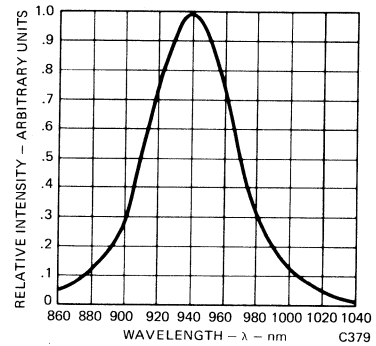


Fig. 6. Spectral Distribution

NOTES

1. The leads of the device were immersed in molten solder, heated to a temperature of 230°C, to a point 1/16 inch from the body of the device per MIL-S-750.
2. The total external radiated power output measurements are made with a Centralab 110C solar cell terminated into a 100Ω impedance.
3. The axis of spatial distribution are typically within a 10° cone with reference to the central axis of the device.

5

DISPLAYS

Displays

QUICK REFERENCE CHART

MODEL NO.	DIGIT HEIGHT	COLOR	PEAK WAVE-LENGTH	BRIGHTNESS (ft.-L) OR LUMINOUS INTENSITY (μcd) (per SEG. MIN.)	VOLTS-MAX. (V _F /SEG.)	TEST CONDITION (I _F)	PRODUCT FEATURES
MAN1A	.270 in.	Red	660 nm	100 ft.-L	4.0 V	20 mA	Low Brightness 7 Segment
MAN10A	.270 in.	Red	660 nm	100 ft.-L	4.0 V	10 mA	High Brightness Low Current
MAN1001A	.270 in.	Red	660 nm	100 ft.-L	4.0 V	20 mA	Polarity/Overflow for MAN1A
MAN101A	.270 in.	Red	660 nm	100 ft.-L	4.0 V	10 mA	Polarity/Overflow for MAN10A
MAN2A	.320 in.	Red	650 nm	125 μcd	2.0 V	10 mA	35 Diode Alpha-Numeric
MAN2815	.135 in.	Red	660 nm	70 μcd (typ.)	1.75 V	2.5 mA	8-Character 14 seg. A/N
MAN3610A	.300 in.	Orange	630 nm	510 μcd	2.5 V	10 mA	Common Anode; RHDP
MAN3620A	.300 in.	Orange	630 nm	510 μcd	2.5 V	10 mA	Common Anode; LHDP
MAN3630A	.294 in.	Orange	630 nm	510 μcd	2.5 V	10 mA	Common Anode; RHDP Overflow (± 1)
MAN3640A	.300 in.	Orange	630 nm	510 μcd	2.5 V	10 mA	Common Cathode; RHDP
MAN51A	.300 in.	Green	565 nm	125 μcd	3.5 V	10 mA	Common Anode; RHDP
MAN52A	.300 in.	Green	565 nm	125 μcd	3.5 V	10 mA	Common Anode; LHDP
MAN53A	.294 in.	Green	565 nm	125 μcd	3.5 V	10 mA	Common Anode; RHDP Overflow (± 1)
MAN54A	.300 in.	Green	565 nm	125 μcd	3.5 V	10 mA	Common Cathode; RHDP
MAN71A	.300 in.	Red	650 nm	125 μcd	2.0 V	10 mA	Common Anode; RHDP
MAN72A	.300 in.	Red	650 nm	125 μcd	2.0 V	10 mA	Common Anode; LHDP
MAN73A	.294 in.	Red	650 nm	125 μcd	2.0 V	10 mA	Common Anode; RHDP Overflow (± 1)
MAN74A	.300 in.	Red	650 nm	125 μcd	2.0 V	10 mA	Common Cathode; RHDP
MAN81A	.300 in.	Yellow	590 nm	320 μcd	3.5 V	10 mA	Common Anode; RHDP
MAN82A	.300 in.	Yellow	590 nm	320 μcd	3.5 V	10 mA	Common Anode; LHDP
MAN83A	.294 in.	Yellow	590 nm	320 μcd	3.5 V	10 mA	Common Anode; RHDP (Overflow ± 1)
MAN84A	.300 in.	Yellow	590 nm	320 μcd	3.5 V	10 mA	Common Cathode; RHDP
MAN4610A	.400 in.	Orange	630 nm	510 μcd	2.5 V	10 mA	Common Anode; RHDP
MAN4630A	.400 in.	Orange	630 nm	510 μcd	2.5 V	10 mA	Common Anode; RHDP Overflow (± 1)
MAN4640A	.400 in.	Orange	630 nm	510 μcd	2.5 V	10 mA	Common Cathode; RHDP
MAN6610	.560 in.	Orange	630 nm	510 μcd	2.5 V	10 mA	2 Digit; Common Anode; RHDP
MAN6630	.560 in.	Orange	630 nm	510 μcd	2.5 V	10 mA	1½ Digit; Common Anode; Overflow (± 1.8); RHDP
MAN6640	.560 in.	Orange	630 nm	510 μcd	2.5 V	10 mA	2 Digit; Common Cathode; RHDP
MAN6650	.560 in.	Orange	630 nm	510 μcd	2.5 V	10 mA	1½ Digit; Common Cathode; Overflow (± 1.8); RHDP
MAN6660	.560 in.	Orange	630 nm	510 μcd	2.5 V	10 mA	Single digit; Common Anode; RHDP
MAN6680	.560 in.	Orange	630 nm	510 μcd	2.5 V	10 mA	Single digit; Common Cathode; RHDP
MAN6710	.560 in.	Red	650 nm	125 μcd	2.0 V	10 mA	2 Digit; Common Anode; RHDP
MAN6730	.560 in.	Red	650 nm	125 μcd	2.0 V	10 mA	1½ Digit; Common Anode; Overflow (± 1.8); RHDP
MAN6740	.560 in.	Red	650 nm	125 μcd	2.0 V	10 mA	2 Digit; Common Cathode; RHDP
MAN6750	.560 in.	Red	650 nm	125 μcd	2.0 V	10 mA	1½ Digit; Common Cathode; Overflow (± 1.8); RHDP
MAN6760	.560 in.	Red	650 nm	125 μcd	2.0 V	10 mA	Single Digit; Common Anode; RHDP
MAN6780	.560 in.	Red	650 nm	125 μcd	2.0 V	10 mA	Single Digit; Common Cathode; RHDP

Models shown in bold type are industry standard products.

All Monsanto displays, with the exception of the products MAN1A, MAN10A, MAN1001A, MAN101A and MAN2A, are categorized for brightness, virtually eliminating hand sorting by the customer. These brightness categories are established to give a ratio of 1:8 from maximum brightness to minimum brightness within a single category. The category designation is marked on the device after the date code.

Due to improvements in product brightness, there is essentially no yield to this category.

CATEGORY	MIN μcd	MAX μcd
A	74	142
B	125	225
C	200	360
D	320	576
E	510	918
F	820	1476
G	1310	2358
H	2100	3780

Monsanto

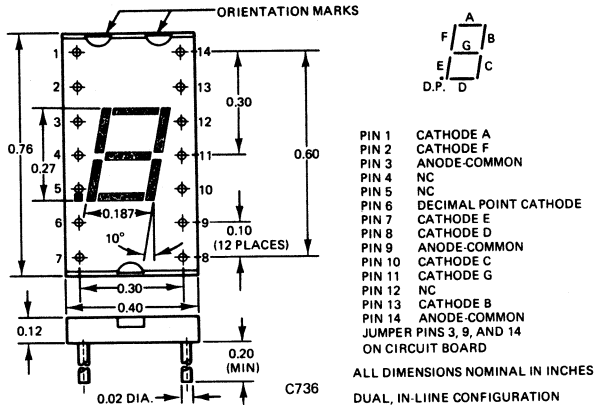
MAN1 MAN1A

.27" RED SEVEN SEGMENT DISPLAY

PRODUCT DESCRIPTION

The MAN1 is a seven segment diffused planar GaAsP light emitting diode array. It is mounted on a dual in-line 14 pin substrate and then encapsulated in clear epoxy for protection. It is capable of displaying all digits and nine distinct letters. The MAN1A has identical specifications, but is encapsulated in high contrast red epoxy.

PACKAGE DIMENSIONS



FEATURES

- High brightness . . . Typically 350 ft-L @ 20 mA
- Single plane, wide angle viewing . . . 150°
- Unobstructed emitting surface
- Standard 14 pin dual-in-line package configuration
- Long operating life . . . solid state reliability
- Shock resistant
- Operates with IC voltage requirements
- Small size; offering unique styling advantages
- All numbers plus 9 distinct letters
- Usable for wide viewing angle requirements
- Usable in vibrating environment, impervious to vibration
- Directly compatible with integrated circuits

The MAN1 is for industrial and military applications such as:

- Digital readout displays
- Cockpit readout displays

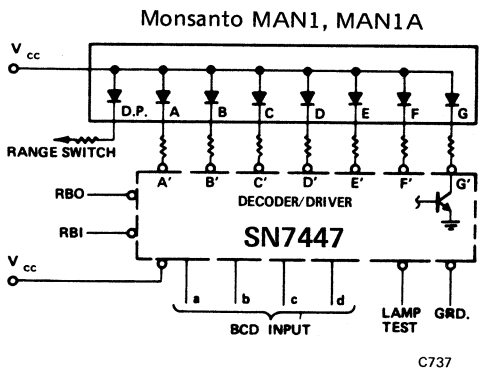
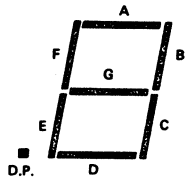
ABSOLUTE MAXIMUM RATINGS

Power dissipation @ 25°C ambient	750 mW
Derate linearly from 25°C	10 mW/°C
Storage and operating temp	-55°C to 100°C
Continuous forward current	
Total	240 mA
Per segment	30 mA
Decimal point	30 mA
Reverse Voltage	
Per segment	10.0 volts
Decimal point	5.0 volts
Solder time at 260°C (see note 5)	5 sec

ELECTRO-OPTICAL CHARACTERISTICS

CHARACTERISTICS	(25°C Ambient Temperature Unless Otherwise Specified)			UNITS	TEST CONDITIONS
	MIN.	TYP.	MAX.		
Brightness (note 1)					
Segment	100	350		ft-L	I _F =20 mA, λ=650 nm
Decimal point	100	350		ft-L	I _F =20 mA, λ=650 nm
Peak emission wave length	630		700	nm	
Spectral line half width		20		nm	
Forward voltage					
Segment		3.4	4.0	V	I _F =20 mA
Decimal point		1.6	2.0	V	I _F =20 mA
Dynamic resistance					
Segment		11		Ω	I _F =20 mA
Decimal point		5.5		Ω	I _F =20 mA
Capacitance					
Segment		80		pF	V=0
Decimal point		135		pF	V=0
Reverse Current					
Segment			100	μA	V _R =10.0 volts
Decimal point			100	μA	V _R = 5.0 volts

**DECODER/DRIVER
FUNCTIONAL DIAGRAM**



TYPICAL TRUTH TABLE

INPUT CODE				OUTPUT STATE							DISPLAY
d	c	b	a	A'	B'	C'	D'	E'	F'	G'	
0	0	0	0	0	0	0	0	0	0	1	0
0	0	0	1	1	0	0	1	1	1	1	1
0	0	1	0	0	0	1	0	0	1	0	2
0	0	1	1	0	0	0	0	1	1	0	3
0	1	0	0	1	0	0	1	1	0	0	4
0	1	0	1	0	1	0	0	1	0	0	5
0	1	1	0	1	1	0	0	0	0	0	6
0	1	1	1	0	0	0	1	1	1	1	7
1	0	0	0	0	0	0	0	0	0	0	8
1	0	0	1	0	0	0	1	1	0	0	9

TYPICAL CURVES

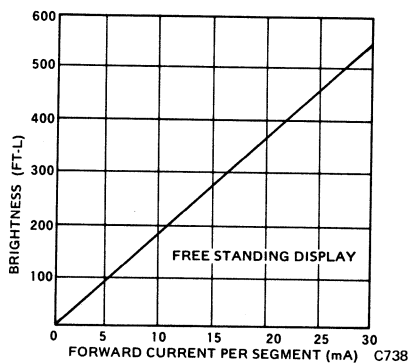


Figure 1 Brightness vs. Forward Current

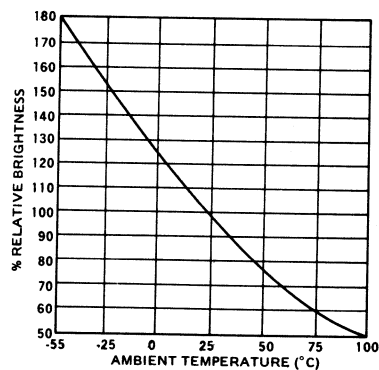


Figure 2 Brightness vs. Temperature

TYPICAL THERMAL CHARACTERISTICS

Thermal Resistance (note 4) Junction to free air θ_{JA}
Wavelength Temperature Coefficient (case temp)	3.0 Å/°C
Forward Voltage Temperature Coefficient	-3.0 mV/°C

NOTES

1. As measured with a Photo Research Corp. Spot Brightness Meter with "SPECTAR" L175 lens in the brightest region of the emitting surface. Brightness cannot vary more than $\pm 50\%$ between all segments.
2. The curve in Figure 2 is normalized to the brightness at 25°C to indicate the relative efficiency over the operating temperature range.
3. For contrast improvement Polaroid HRC7 circular polarizer filter can be used. Non-glare circular polarizer filter will provide further enhancement in display visibility.
4. Thermal resistance (junction to ambient) value of any one segment with all segments in operation.
5. Leads of the device immersed to 1/16 inches from the body. Maximum device surface temperature is 140°C.

Monsanto

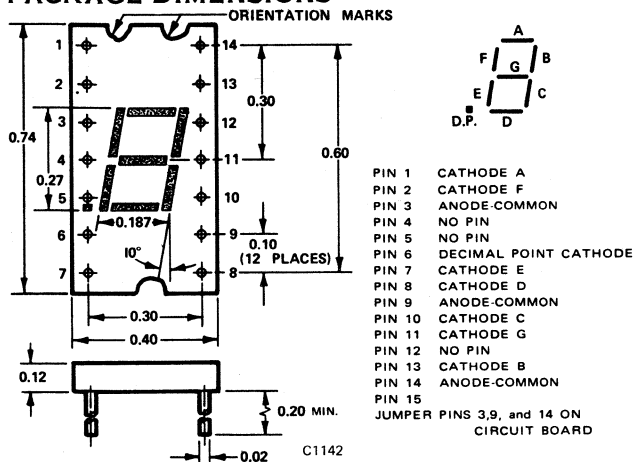
MAN10 MAN10A

.27" ALPHANUMERIC DISPLAY

PRODUCT DESCRIPTION

The MAN10 is a seven segment diffused planar GaAsP light emitting diode array. It is mounted on a dual in-line 14 pin substrate and then encapsulated in clear epoxy for protection. It is capable of displaying all digits and nine distinct letters. The MAN-10A has identical specifications but is encapsulated in high contrast red epoxy.

PACKAGE DIMENSIONS



FEATURES

- High brightness . . . Typically 350 ft-L @ 10 mA
- Single plane, wide angle viewing . . . 150°
- Unobstructed emitting surface
- Standard 14 pin dual-in-line package configuration
- Long operating life . . . solid state reliability
- Shock resistant
- Operates with IC voltage requirements
- Small size; offering unique styling advantages
- All numbers plus 9 distinct letters
- Usable for high ambient applications
- Usable in vibrating environment, impervious to vibration

The MAN10 is for industrial and military applications such as:

- Digital readout displays
- Cockpit readout displays
- Battery operated equipment

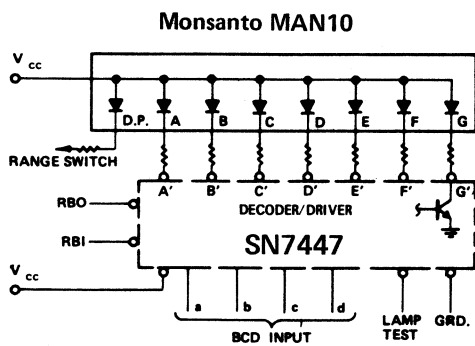
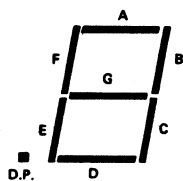
ABSOLUTE MAXIMUM RATINGS

Power dissipation @ 25°C ambient	750 mW
Derate linearly from 25°C	10 mW/°C
Storage and operating temp	-55°C to 100°C
Continuous forward current	
Total	240 mA
Per segment	30 mA
Decimal point	30 mA
Reverse Voltage	
Per segment	10.0 volts
Decimal point	5.0 volts
Solder time at 260°C (see note 5)	5 sec

ELECTRO-OPTICAL CHARACTERISTICS

CHARACTERISTICS	(25°C Ambient Temperature Unless Otherwise Specified)			UNITS	TEST CONDITIONS
	MIN.	TYP.	MAX.		
Brightness (note 1)					
Segment	100	350		ft-L	I _F =10 mA, λ=660 nm
Decimal point	100	350		ft-L	I _F =10 mA, λ=660 nm
Peak emission wave length	630		700	nm	
Spectral line half width		20		nm	
Forward voltage					
Segment		3.4	4.0	V	I _F = 10 mA
Decimal point		1.6	2.0	V	I _F = 10 mA
Dynamic resistance					
Segment		11		Ω	I _F =20 mA
Decimal point		5.5		Ω	I _F =20 mA
Capacitance					
Segment		80		pF	V=0
Decimal point		135		pF	V=0
Reverse Current					
Segment			100	μA	V _R =10.0 volts
Decimal point			100	μA	V _R = 5.0 volts

**DECODER/DRIVER
FUNCTIONAL DIAGRAM**



C1143

TYPICAL TRUTH TABLE

INPUT CODE				OUTPUT STATE							DISPLAY
d	c	b	a	A'	B'	C'	D'	E'	F'	G'	
0	0	0	0	0	0	0	0	0	0	1	0
0	0	0	1	1	0	0	1	1	1	1	1
0	0	1	0	0	0	1	0	0	1	0	2
0	0	1	1	0	0	0	0	1	1	0	3
0	1	0	0	1	0	0	1	1	0	0	4
0	1	0	1	0	1	0	0	1	0	0	5
0	1	1	0	1	1	0	0	0	0	0	6
0	1	1	1	0	0	0	1	1	1	1	7
1	0	0	0	0	0	0	0	0	0	0	8
1	0	0	1	0	0	0	1	1	0	0	9

TYPICAL CURVES

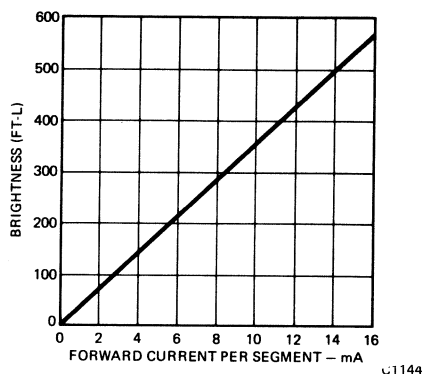


Figure 1 Brightness vs. Forward Current

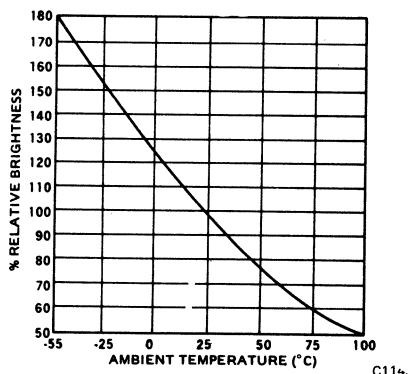


Figure 2 Brightness vs. Temperature

TYPICAL THERMAL CHARACTERISTICS

Thermal Resistance (note 4) Junction to free air θ_{JA}440°C/W
Wavelength Temperature Coefficient (case temp)	3.0 Å/°C
Forward Voltage Temperature Coefficient	-3.0 mV/°C

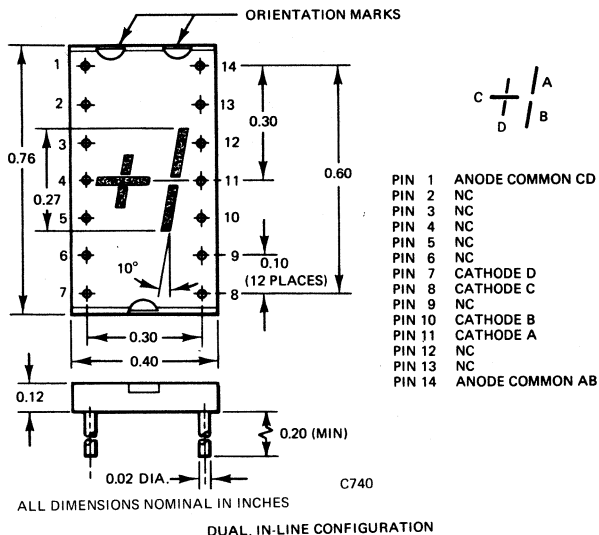
NOTES

1. As measured with a Photo Research Corp. Spot Brightness Meter with "SPECTAR" L175 lens in the brightest region of the emitting surface. Brightness cannot vary more than $\pm 50\%$ between all segments.
2. The curve in Figure 2 is normalized to the brightness at 25°C to indicate the relative efficiency over the operating temperature range.
3. For contrast improvement Polaroid HRC7 circular polarizer filter can be used. Non-glare circular polarizer filter will provide further enhancement in display visibility.
4. Thermal resistance (junction to ambient) value of any one segment with all segments in operation.
5. Leads of the device immersed to 1/16 inches from the body. Maximum device surface temperature is 140°C.

PRODUCT DESCRIPTION

The MAN1001 is a four segment, diffused planar GaAsP LED array. It is mounted on a dual-in-line 14 pin substrate and then encapsulated in clear epoxy for protection. It provides polarity and overflow display capability. The MAN1001A has identical specifications but is encapsulated in red epoxy.

PACKAGE DIMENSIONS



FEATURES & APPLICATIONS

- High brightness - typically 350 ft-L @ 20 mA
- Single plane, wide angle viewing - 150°
- Unobstructed emitting surface
- Standard 14 pin dual-in-line package configuration
- Long operating life - solid state reliability
- Shock resistant
- Operates with IC voltage requirements
- Small size offering unique styling advantages
- Directly compatible with integrated circuits
- Usable for wide viewing angle requirements
- Usable in vibrating environment, impervious to vibration

It is ideal for industrial and military applications such as:

- Digital readout displays
- Cockpit readout displays

ABSOLUTE MAXIMUM RATINGS

Power dissipation @ 25°C	480 mW
Derate linearly from 25°C	6.4 mW/°C
Storage and operating temperature	-55°C to 100°C
Continuous forward current	
Total	120 mA
Per segment	30 mA
Reverse voltage	
Per segment	10.0 volts
Solder time at 260°C (see note 5)	5 sec

ELECTRO-OPTICAL CHARACTERISTICS

(25°C Ambient Temperature Unless Otherwise Specified)

CHARACTERISTICS	MIN.	TYP.	MAX.	UNITS	TEST CONDITIONS
Brightness (note 1) segment	100	350		ft-L	I _F =20 mA, λ= 655 nm
Peak emission wave length	630		700	nm	
Spectral line half width		20		nm	
Forward voltage segment		3.4	4.0	V	I _F =20 mA
Dynamic resistance		11		Ω	I _F =20 mA
Capacitance segment		80		pF	V=0
Reverse current segment			100	μA	V _R =10.0 V

TYPICAL THERMAL CHARACTERISTICS

Thermal resistance (note 4) junction to free air @ J _A440°C/W
Wavelength temperature coefficient (case temperature)	0.3 nm/°C
Forward voltage temperature coefficient	-4.0 mV/°C

TYPICAL CURVES (25°C Free Air Temperature Unless Otherwise Specified)

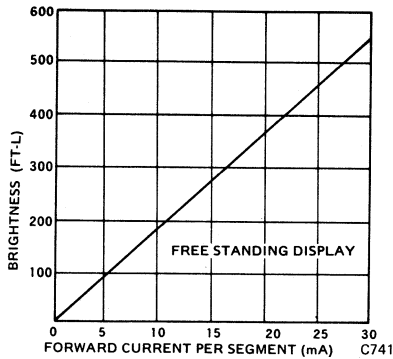


Figure 1 Brightness vs. Forward Current

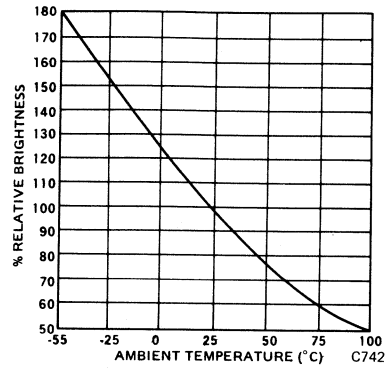
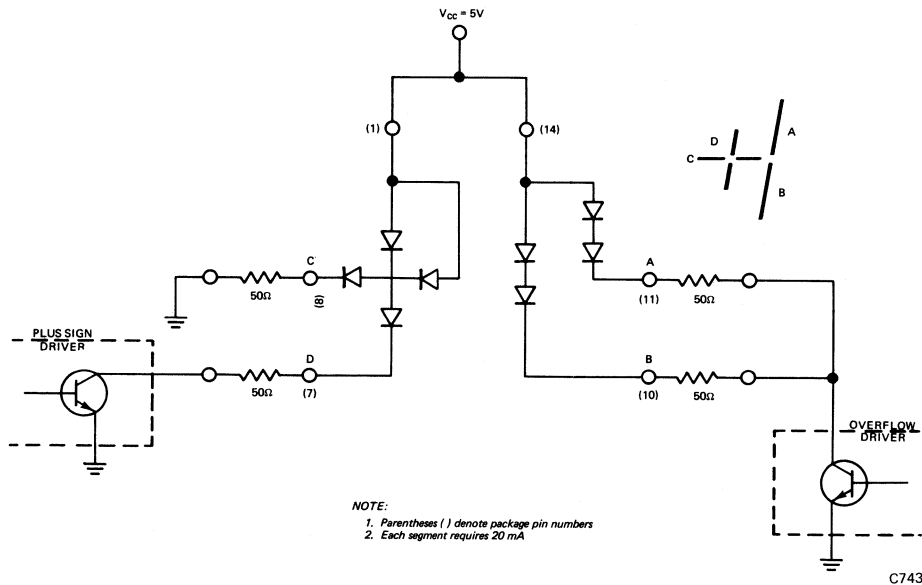


Figure 2 Brightness vs. Temperature

DRIVING CIRCUITRY FOR THE MAN1001, MAN1001A



NOTES

1. As measured with a Photo Research Corp. Spot Brightness Meter with "SPECTAR" L175 lens in the brightest region of the emitting surface. Brightness cannot vary more than ±50% between all segments.
2. The curve in Figure 2 is normalized to the brightness at 25°C to indicate the relative efficiency over the operating temperature range.
3. For contrast improvement Polaroid HRCO7 circular polarizer filter can be used. Non-glare circular polarizer filter will provide further enhancement in display visibility.
4. Thermal resistance (junction to ambient) value of any one segment with all segments in operation.
5. Leads of the device immersed to 1/16 inches from the body. Maximum device surface temperature is 140°C.

Monsanto

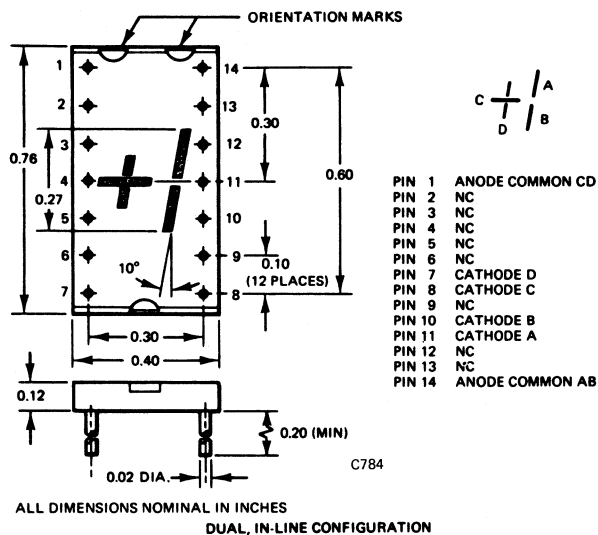
MAN101 MAN101A

.27" RED POLARITY AND OVERFLOW DISPLAY

PRODUCT DESCRIPTION

The MAN101 is a diffused planar GaAsP light emitting diode array. It is mounted on a dual in-line 14 pin substrate and then encapsulated in clear epoxy for protection. It is designed to present polarity and overflow information when used with the MAN10 seven segment display. The MAN101A has identical specifications but is encapsulated in high contrast red epoxy.

PACKAGE DIMENSIONS



FEATURES

- High brightness . . . Typically 350 ft-L @ 10 mA
- Single plane, wide angle viewing . . . 150°
- Unobstructed emitting surface
- Standard 14 pin dual-in-line package configuration
- Long operating life . . . solid state reliability
- Shock resistant
- Operates with IC voltage requirements
- Small size; offering unique styling advantages
- Usable for high ambient applications
- Usable in vibrating environment, impervious to vibration

The MAN101 is for industrial and military applications such as:

- Digital readout displays
- Cockpit readout displays
- Battery operated equipment

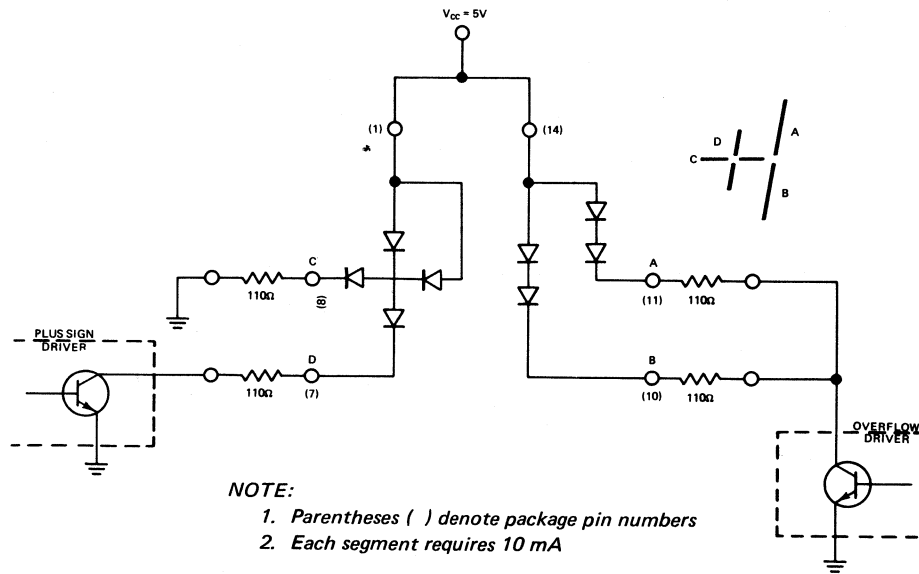
ABSOLUTE MAXIMUM RATINGS

Power dissipation @ 25°C ambient	480 mW
Derate linearly from 25°C	.64 mW/°C
Storage and operating temp	-55°C to 100°C
Continuous forward current	
Total	120 mA
Per segment	30 mA
Reverse Voltage	
Per segment	10.0 volts
Solder time at 260°C (see note 5)	5 sec

ELECTRO-OPTICAL CHARACTERISTICS (25°C Ambient Temperature Unless Otherwise Specified)

CHARACTERISTICS	MIN.	TYP.	MAX.	UNITS	TEST CONDITIONS
Brightness (note 1)					
Segment	100	350		ft-L	I _F = 10 mA, λ = 650 nm
Peak emission wave length	630		700	nm	
Spectral line half width		20		nm	
Forward voltage					
Segment		3.4	4.0	V	I _F = 10 mA
Dynamic resistance					
Segment		11		Ω	I _F = 20 mA
Capacitance					
Segment		80		pF	V = 0
Reverse Current					
Segment			100	μA	V _R = 10.0 volts

DRIVING CIRCUITRY FOR THE MAN101, MAN101A



C785

TYPICAL CURVES

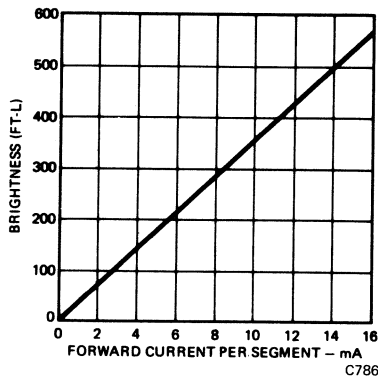


Figure 1 Brightness vs. Forward Current

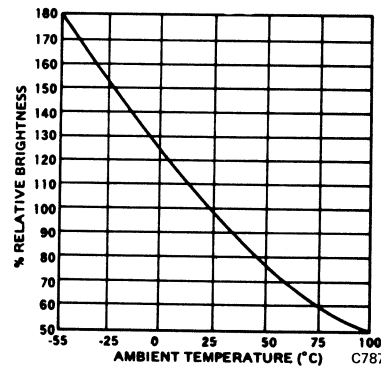


Figure 2 Brightness vs. Temperature

TYPICAL THERMAL CHARACTERISTICS

Thermal Resistance (note 4) Junction to free air θ_{JA}	440°C/W
Wavelength Temperature Coefficient (case temp)	3.0 Å/°C
Forward Voltage Temperature Coefficient	-4.0 mV/°C

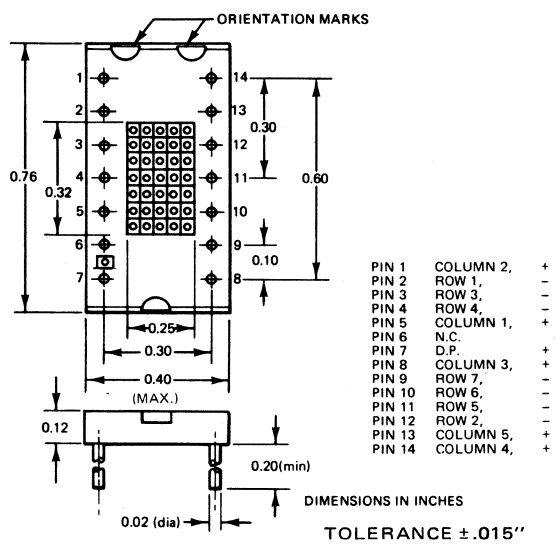
NOTES

- As measured with a Photo Research Corp. Spot Brightness Meter with "SPECTAR" L175 lens in the brightest region of the emitting surface. Brightness cannot vary more than $\pm 50\%$ between all segments.
- The curve in Figure 2 is normalized to the brightness at 25°C to indicate the relative efficiency over the operating temperature range.
- For contrast improvement Polaroid HRC7 circular polarizer filter can be used. Non-glare circular polarizer filter will provide further enhancement in display visibility.
- Thermal resistance (junction to ambient) value of any one segment with all segments in operation.
- Leads of the device immersed to 1/16 inches from the body. Maximum device surface temperature is 140°C.

PRODUCT DESCRIPTION

The MAN2A is a 35 diode diffused planar GaAsP LED alpha-numeric array with a decimal point. It is mounted on a dual in-line, 14-pin substrate with a high contrast red epoxy lens. It is capable of displaying the 64 character ASCII code.

PACKAGE DIMENSIONS



FEATURES & APPLICATIONS

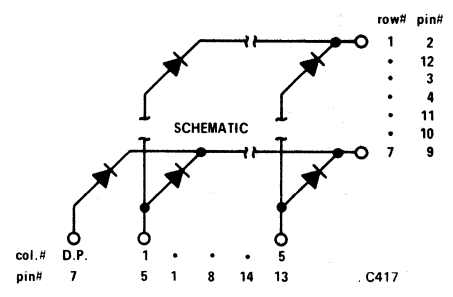
- Visible, bright red, high contrast display
- 36 light emitting diodes including decimal point
- Capable of displaying 64 ASCII characters
- Single plane, wide angle viewing
- Long life, shock resistant, small size

It is ideal for industrial and military applications such as:

- Keyboard verifier
- Film annotation— 2^{36} bits available
- Avionics display
- Computer peripheral displays

ABSOLUTE MAXIMUM RATINGS

Single Diode	
DC forward current	20 mA
Pulsed forward current peak (50 μ s, 20% duty cycle)	100 mA
Reverse voltage	5 V
Storage temperature	-40°C to 85°C
Operating temperature	-40°C to 85°C
Diode Array	
Average power dissipation @ 25°C ambient	750 mW
Derate linearly from 25°C	12.5 mW/°C
DC current per diode for worst case A/N	20 mA
DC current per diode for all 35 diodes plus DP	11 mA
Solder time at 260°C (notes 3, 4)	5 sec



ELECTRO-OPTICAL CHARACTERISTICS (PER DIODE)

(25°C Ambient Temperature Unless Otherwise Specified)

CHARACTERISTICS	MIN.	TYP.	MAX.	UNITS	TEST CONDITIONS
Average Luminous intensity per character (See note 1)	125			μ cd	$I_F = 10$ mA
Peak emission wavelength		660		nm	
Spectral line half width		20		nm	
Forward voltage			2.0	V	$I_F = 20$ mA
Capacitance		200		pF	$V = 0$
Reverse current			100	μ A	$V_R = 5$ V

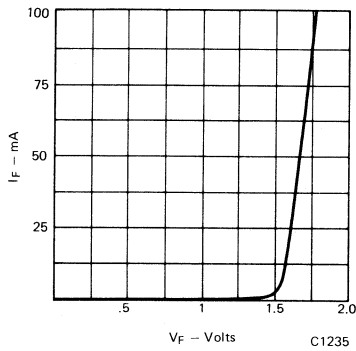
TYPICAL CURVES

Fig. 1. Forward Current vs. Forward Voltage each LED

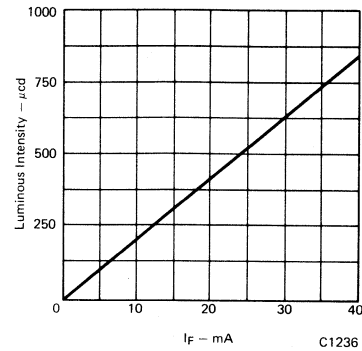


Fig. 2. Light Intensity vs. Forward Current each LED

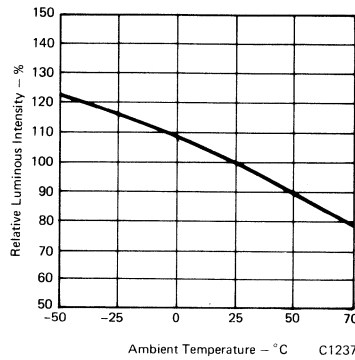


Fig. 3. Relative Luminous Intensity vs. Ambient Temperature

NOTES

1. The characteristic average luminous intensity is obtained by summing the luminous intensity of each diode and dividing by 35. The standard of measurement is the Photo Research Spectra Microcandela Meter corrected for wavelength error. Intensity will not vary more than $\pm 33.3\%$ between all diodes in a character.
2. The curve in Figure 3 is normalized to the brightness of 25°C to indicate the relative luminous intensity over the operating temperature range.
3. Leads of the device immersed to 1/16 inches from the body. Maximum device surface temperature is 140°C .
4. For flux removal, Freon TF, Freon TE, isopropanol or water may be used up to their boiling points.

RECOMMENDED FILTERS

For optimum on and off contrast, one of the following filters or equivalents should be used over the display:

Panelgraphic Red 60
Homalite 100-1670



Preliminary Data Sheet

MAN2815
8-CHARACTER

14-SEGMENT ALPHA-NUMERIC DISPLAY

PRODUCT DESCRIPTION

The MAN2815 is an end-stackable eight-character alpha-numeric display capable of displaying all alpha and numeric characters plus many symbols. The display consists of eight monolithic, red GaAsP chips. Each chip has 14 segments in the "British Flag" configuration. A decimal point (or period) is included on-board the chip.

The eight characters are mounted on 0.175" centers so that 5.7 characters consume only one inch of linear panel space. The display is internally wired for multiplex operation (common cathode).

The MAN2815 utilizes a 24-pin, double dual-in-line package. The package thickness is 0.140". A built-in lens increases the character height of the display from 0.100" to an apparent height of 0.135". The lens is clear epoxy. For optimum on/off contrast, it is recommended that the display be placed directly behind a red filter such as a Panelgraphic Red 60 or a Homalite 100-1605.

PRODUCT APPLICATION

The MAN2815 is intended for use in lightweight, compact intelligent data terminals where operator interface requires the display of alpha-numeric information. Generally, the number of alpha-numeric characters to be displayed per system will be less than 80 characters.

PRODUCT FEATURES

The MAN2815 combines the unique features of LED's—ruggedness, high reliability, long-life, low-voltage operation—with a unique approach to alpha-numeric information display. The 14-segment display provides complete alpha-numeric information at a system cost not far above a numeric information display system. Compared to many 5x7 dot matrix systems, the 14-segment approach reduces system cost by one-half. Not only are the display and driving circuits lower in cost than many 5x7 dot matrix systems, but power requirements are also reduced.

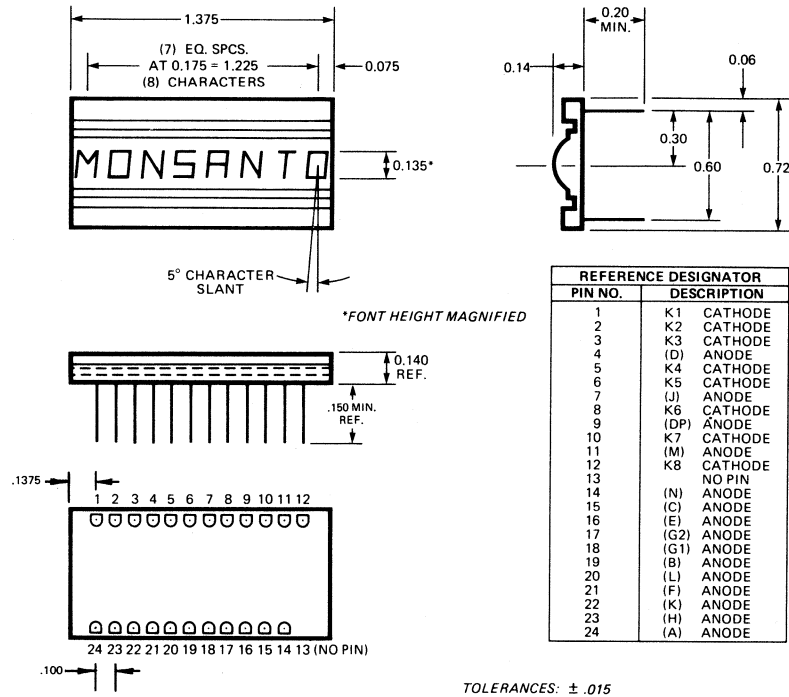
ELECTRO-OPTICAL CHARACTERISTICS (25°C)

PARAMETER	TEST CONDITIONS	MIN	TYP	MAX	UNITS
Forward Voltage	I _F = 20 mA dc/segment	1.45		2.0	Volts
Reverse Voltage	I _R = 100 μA dc/segment	5.0			Volts
Average Luminous Intensity/Segment	I _F = 2.5 mA dc/segment I _F = 2.5 mA pulsed at 1 kHz, 20 mA peak, 1/8 duty cycle	35	70		μcd
		60	120		μcd
Luminous Intensity Ratio, Segment-to-Segment within a character				1.8:1	
Luminous Intensity Ratio, character-to-character within a display				2.0:1	nm
Peak Emission Wavelength			660		

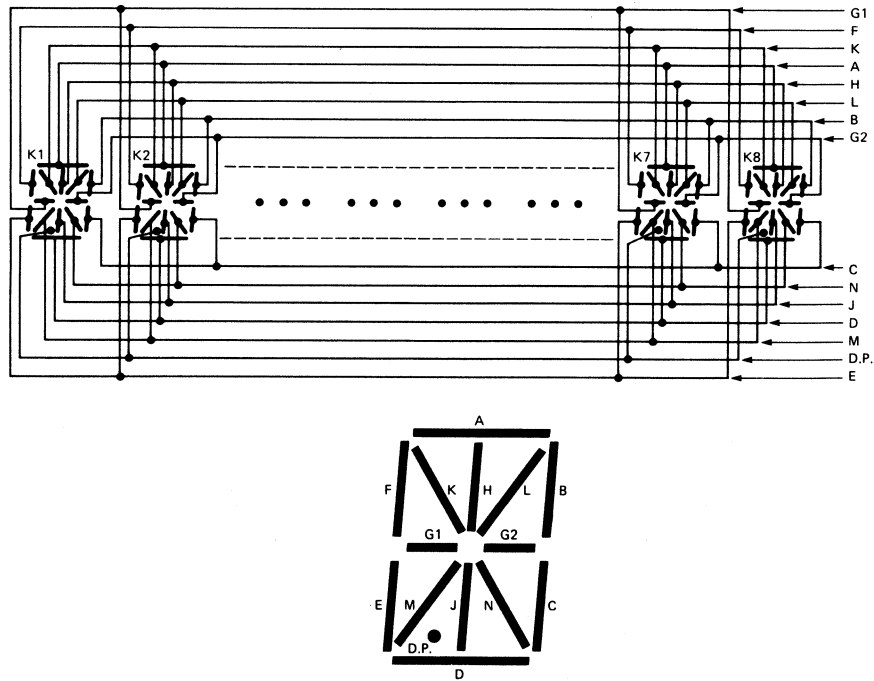
ABSOLUTE MAXIMUM RATINGS

- Per Segment:
 - DC Forward Current: 20 mA
 - Pulsed Forward Current Peak (50 μs, 20% duty cycle): 100 mA
 - Reverse Voltage: 5 Volts
- Per Character:
 - DC Forward Current: 50 mA
 - Average Power Dissipation @ 25°C Ambient: 80 mW
 - Derate Linearly from 25°C: -1.3 mW/°C
- Total Package:
 - Average Power Dissipation @ 25°C Ambient: 640 mW
 - Derate Linearly from 25°C: -10.5 mW/°C
 - Storage Temperature: -40°C to +85°C
 - Operating Temperature: -40°C to +85°C

PACKAGE DIMENSIONS



ELECTRICAL CONNECTIONS



Monsanto

0.300-INCH SEVEN SEGMENT DISPLAY

**GREEN
ORANGE
RED
YELLOW**

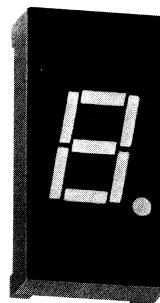
**MAN50A
MAN3600A
MAN70A
MAN80A**

FEATURES

- Common anode or common cathode models
- Red, yellow, green and orange
- Fast switching—excellent for multiplexing
- Low power consumption
- Bold solid segments that are highly legible
- Solid state reliability—long operation life
- Impact resistant plastic construction
- Directly compatible with integrated circuits
- High brightness with high contrast
- Standard 14 pin dual in-line package configuration
- Wide angle viewing . . . 150°

For industrial and consumer applications such as:

- Digital readout displays
- Instrument panels
- Point of sale equipment
- Calculators
- Digital clocks



DESCRIPTION

The MAN50A, MAN3600A, MAN70A and MAN80A Series provides a choice of color of LED displays. Standard units are available in red, green, orange and yellow, with common anode right hand decimal, common anode left hand decimal, common cathode right hand decimal, and common anode overflow (± 1) with right hand decimal. They can be mounted in arrays with 0.400-inch (10.16 mm) center-to-center spacing.

MODEL NUMBERS

PART NO.	COLOR	DESCRIPTION
MAN51A	Green	Common Anode; Right Hand Decimal
MAN52A	Green	Common Anode; Left Hand Decimal
MAN53A	Green	Common Anode; Overflow ± 1
MAN54A	Green	Common Cathode; Right Hand Decimal
MAN3610A	Orange	Common Anode; Right Hand Decimal
MAN3620A	Orange	Common Anode; Left Hand Decimal
MAN3630A	Orange	Common Anode; Overflow ± 1
MAN3640A	Orange	Common Cathode; Right Hand Decimal
MAN71A	Red	Common Anode; Right Hand Decimal
MAN72A	Red	Common Anode; Left Hand Decimal
MAN73A	Red	Common Anode; Overflow ± 1
MAN74A	Red	Common Cathode; Right Hand Decimal
MAN81A	Yellow	Common Anode; Right Hand Decimal
MAN82A	Yellow	Common Anode; Left Hand Decimal
MAN83A	Yellow	Common Anode; Overflow ± 1
MAN84A	Yellow	Common Cathode; Right Hand Decimal

ELECTRO-OPTICAL CHARACTERISTICS (25°C Free Air Temperature Unless Otherwise Specified)						
		MIN.	TYP.	MAX.	UNITS	TEST CONDITIONS
MAN51A, 52A, 53A, 54A	Luminous intensity, Digit Average (See Note 1)	125			μcd	$I_F = 10 \text{ mA}$
	Decimal point (See Note 3)	60			μcd	$I_F = 10 \text{ mA}$
	Segment "C" or "D" of MAN53A	60			μcd	$I_F = 10 \text{ mA}$
	Peak emission wavelength		565		nm	
	Spectral line half width		40		nm	
	Forward voltage					
	Segment			3.5	V	$I_F = 20 \text{ mA}$
	Decimal point			3.5	V	$I_F = 20 \text{ mA}$
	Dynamic resistance					
	Segment		17		Ω	$I_F = 20 \text{ mA}$
	Decimal point		17		Ω	$I_F = 20 \text{ mA}$
	Capacitance					
	Segment		35		pF	$V = 0$
	Decimal point		35		pF	$V = 0$
Reverse current						
Segment			100	μA	$V_R = 5.0 \text{ V}$	
Decimal point			100	μA	$V_R = 5.0 \text{ V}$	
MAN3610A, 3620A, 3630A, 3640A	Luminous intensity, Digit Average (See Note 1)	510			μcd	$I_F = 10 \text{ mA}$
	Decimal point (See Note 3)	265			μcd	$I_F = 10 \text{ mA}$
	Segment "C" or "D" of MAN3630A	265			μcd	$I_F = 10 \text{ mA}$
	Peak emission wavelength		630		nm	
	Spectral line half width		40		nm	
	Forward voltage					
	Segment			2.5	V	$I_F = 20 \text{ mA}$
	Decimal point			2.5	V	$I_F = 20 \text{ mA}$
	Dynamic resistance					
	Segment		26		Ω	$I_F = 20 \text{ mA}$
	Decimal point		26		Ω	$I_F = 20 \text{ mA}$
	Capacitance					
	Segment		35		pF	$V = 0$
	Decimal point		35		pF	$V = 0$
Reverse current						
Segment			100	μA	$V_R = 5.0 \text{ V}$	
Decimal point			100	μA	$V_R = 5.0 \text{ V}$	
MAN71A, 72A, 73A, 74A	Luminous intensity, Digit Average (See Note 1)	125			μcd	$I_F = 10 \text{ mA}$
	Decimal point (See Note 3)	60			μcd	$I_F = 10 \text{ mA}$
	Segment "C" or "D" of MAN73A	60			μcd	$I_F = 10 \text{ mA}$
	Peak emission wavelength		660		nm	
	Spectral line half width		20		nm	
	Forward voltage					
	Segment			2.0	V	$I_F = 20 \text{ mA}$
	Decimal point			2.0	V	$I_F = 20 \text{ mA}$
	Dynamic resistance					
	Segment		2		Ω	$I_{PK} = 100 \text{ mA}$
	Decimal point		2		Ω	$I_{PK} = 100 \text{ mA}$
	Capacitance					
	Segment		35	80		$V = 0$
	Decimal point		35	80		$V = 0$
Reverse current						
Segment			100	μA	$V_R = 5.0 \text{ V}$	
Decimal point			100	μA	$V_R = 5.0 \text{ V}$	
MAN81A, 82A, 83A, 84A	Luminous intensity, Digit Average (See Note 1)	320			μcd	$I_F = 10 \text{ mA}$
	Decimal point (See Note 3)	160			μcd	$I_F = 10 \text{ mA}$
	Segment "C" or "D" of MAN83A	160			μcd	$I_F = 10 \text{ mA}$
	Peak emission wavelength		585		nm	
	Spectral line half width		40		nm	
	Forward voltage					
	Segment			3.5	V	$I_F = 20 \text{ mA}$
	Decimal point			3.5	V	$I_F = 20 \text{ mA}$
	Dynamic resistance					
	Segment		26		Ω	$I_F = 20 \text{ mA}$
	Decimal point		26		Ω	$I_F = 20 \text{ mA}$
	Capacitance					
	Segment		35		pF	$V = 0$
	Decimal point		35		pF	$V = 0$
Reverse current						
Segment			100	μA	$V_R = 5.0 \text{ V}$	
Decimal point			100	μA	$V_R = 5.0 \text{ V}$	

TYPICAL CURVES

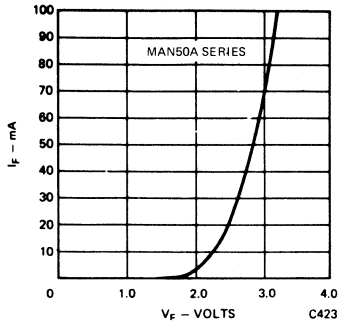


Fig. 1. Forward Current vs. Forward Voltage

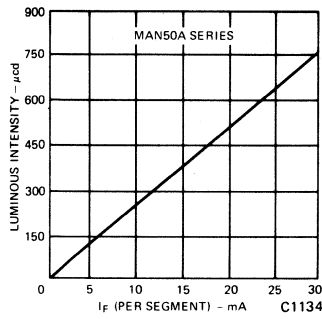


Fig. 2. Luminous Intensity vs. Forward Current

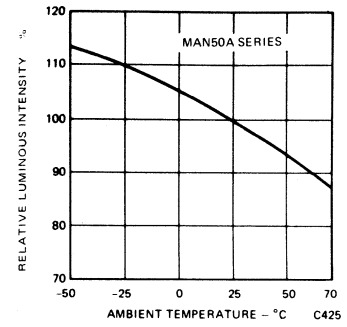


Fig. 3. Luminous Intensity vs. Temperature

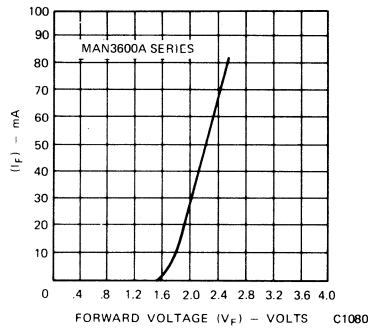


Fig. 4. Forward Current vs. Forward Voltage

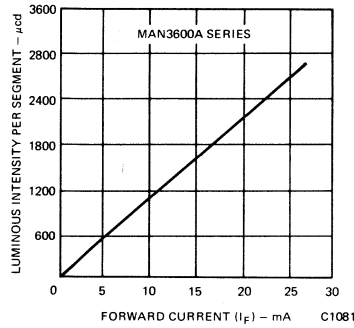


Fig. 5. Luminous Intensity vs. Forward Current

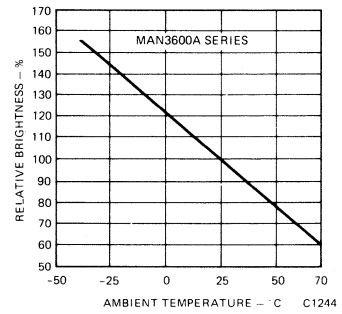


Fig. 6. Luminous Intensity vs. Temperature

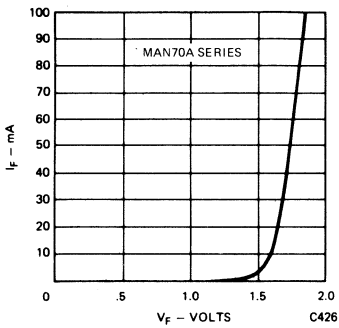


Fig. 7. Forward Current vs. Forward Voltage

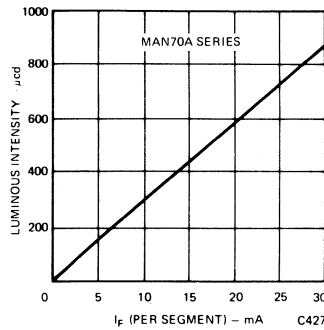


Fig. 8. Luminous Intensity vs. Forward Current

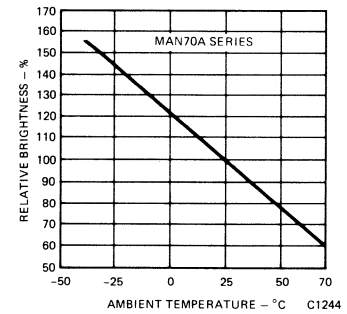


Fig. 9. Luminous Intensity vs. Temperature

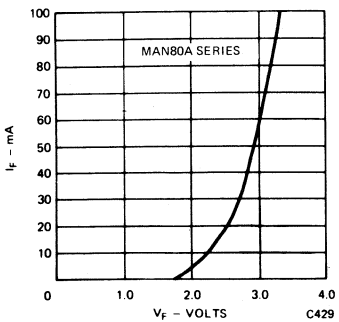


Fig. 10. Forward Current vs. Forward Voltage

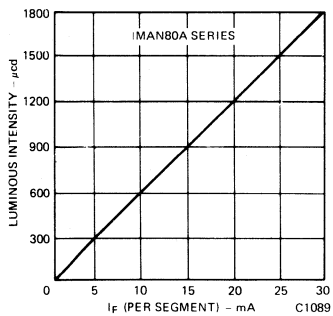


Fig. 11. Luminous Intensity vs. Forward Current

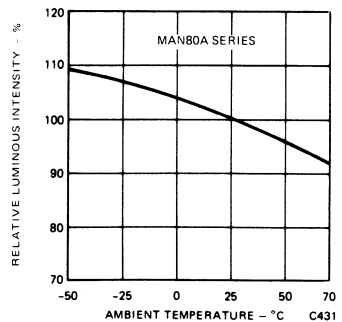


Fig. 12. Luminous Intensity vs. Temperature

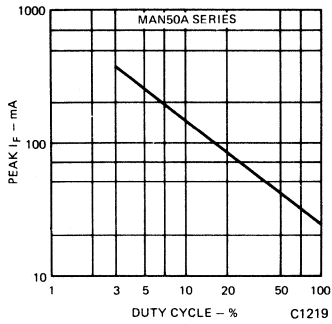


Fig. 13. Max Peak Current vs. Duty Cycle

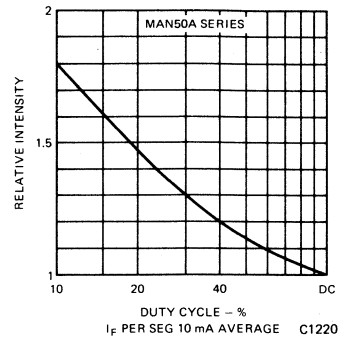


Fig. 14. Luminous Intensity vs. Duty Cycle

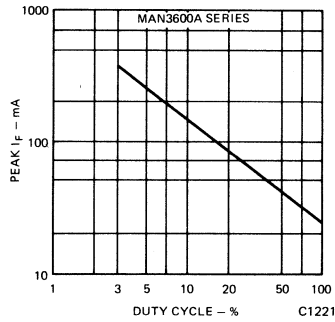


Fig. 15. Max Peak Current vs. Duty Cycle

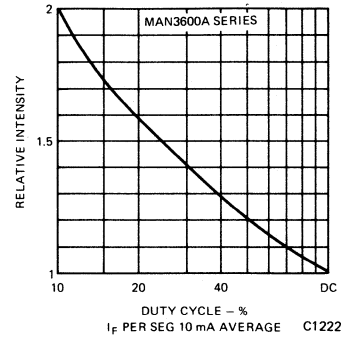


Fig. 16. Luminous Intensity vs. Duty Cycle

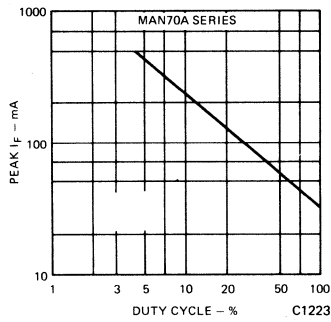


Fig. 17. Max Peak Current vs. Duty Cycle

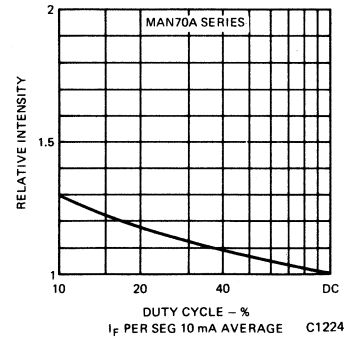


Fig. 18. Luminous Intensity vs. Duty Cycle

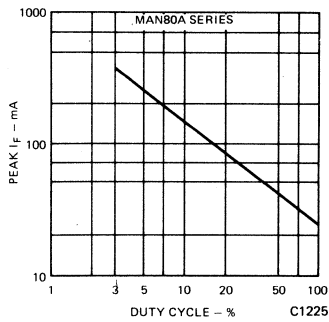


Fig. 19. Max Peak Current vs. Duty Cycle

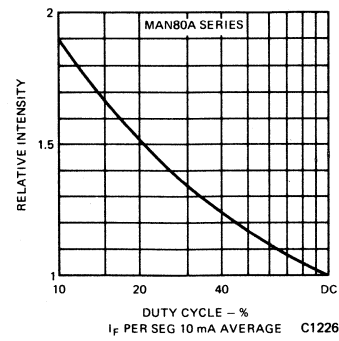
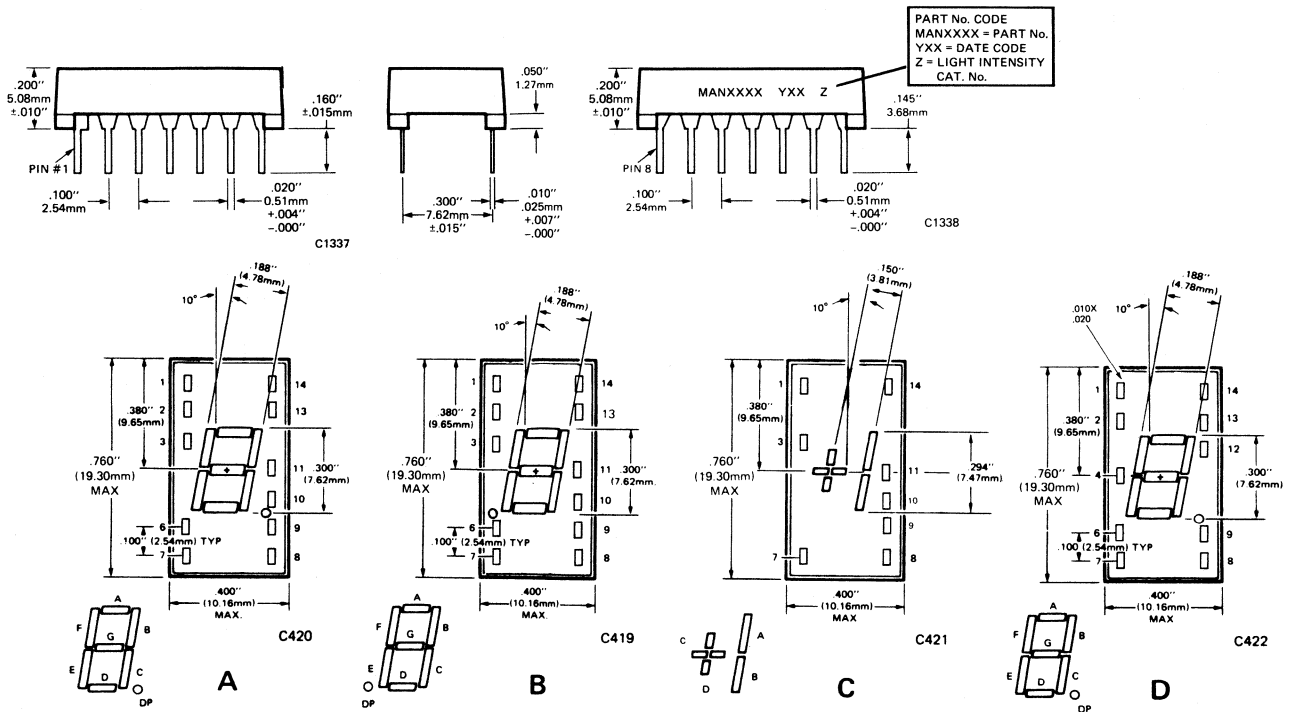


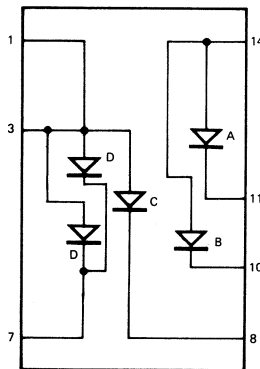
Fig. 20. Luminous Intensity vs. Duty Cycle



PIN CONNECTIONS

PIN NO.	ELECTRICAL CONNECTIONS			
	A	B	C	D
	MAN51A, 3610A, 71A, 81A	MAN52A, 72A, 3620A, 82A	MAN53A, 3630A, 73A, 83A	MAN54A, 3640A, 74A, 84A
1	Cathode A	Cathode A	Anode C, D	Anode F
2	Cathode F	Cathode F	No pin	Anode G
3	Common anode	Common anode	Anode C, D	No pin
4	No pin	No pin	No pin	Common cathode
5	No pin	No pin	No pin	No pin
6	N.C.	Cathode D.P.	No pin	Anode E
7	Cathode E	Cathode E	Cathode D	Anode D
8	Cathode D	Cathode D	Cathode C	Anode C
9	Cathode D.P.	N.C.	N.C.	Anode D.P.
10	Cathode C	Cathode C	Cathode B	No pin
11	Cathode G	Cathode G	Cathode A	No pin
12	No pin	No pin	No pin	Common cathode
13	Cathode B	Cathode B	No pin	Anode B
14	Common anode	Common anode	Anode A, B	Anode A

ELECTRICAL SCHEMATIC



MAN53A, 3630A, 73A, 83A

ABSOLUTE MAXIMUM RATINGS

	MAN51A, 52A, 54A, 3610A, 3620A, 3640A, 81A, 82A, 84A	MAN53A, 3630A, 83A	MAN71A, 72A, 74A	MAN73A
Power dissipation @ 25°C ambient . . .	400 mW	250 mW	700 mW	350 mW
Derate linearly from 25°C	-6.7 mW/°C	-4.2 mW/°C	-11.7 mW/°C	-5.8 mW/°C
Storage and operating temperature . . .	-40°C to 85°C	-40°C to 85°C	-40°C to 85°C	-40°C to 85°C
Continuous forward current				
Total	160 mA	100 mA	240 mA	150 mA
Per segment	20 mA	20 mA	30 mA	30 mA
Decimal point	20 mA	20 mA	30 mA	30 mA
Reverse voltage				
Per segment	3.0 V	3.0 V	5.0 V	5.0 V
Decimal point	3.0 V	3.0 V	5.0 V	5.0 V
Solder time @ 260°C (Note 4 and 5)	5 sec	5 sec	5 sec	5 sec

RECOMMENDED FILTERS

For optimum on and off contrast, one of the following filters or equivalents should be used over the display:

DEVICE TYPE	FILTER
MAN51A	Panelgraphic Green 48
MAN52A	
MAN53A	
MAN54A	
MAN3610A	Panelgraphic Scarlet 65 Homalite 100-1670
MAN3620A	
MAN3630A	
MAN3640A	
MAN71A	Panelgraphic Red 60 Homalite 100-1605
MAN72A	
MAN73A	
MAN74A	
MAN81A	Panelgraphic Yellow 25 or Amber 23 Homalite 100-1720 or 100-1726
MAN82A	
MAN83A	
MAN84A	

TYPICAL THERMAL CHARACTERISTICS**GREEN/YELLOW**

Thermal resistance junction to free air Φ_{JA}	160°C/W
Wavelength temperature coefficient (case temp)	1.0 Å/°C
Forward voltage temperature coefficient	-1.5 mV/°C

RED/ORANGE

Thermal resistance junction to free air Φ_{JA}	160°C/W
Wavelength temperature coefficient (case temp)	1.0 Å/°C
Forward voltage temperature coefficient	-2.0 mV/°C

NOTES:

1. The digit average Luminous Intensity is obtained by summing the Luminous Intensity of each segment and dividing by the total number of segments. The standard of measurement is the Photo Research Spectra Microcandela Meter corrected for wavelength. Intensity will not vary more than $\pm 33.3\%$ between all segments within a digit.
2. The curve in Fig. 3, 6, 9, and 12 is normalized to the brightness at 25°C to indicate the relative luminous intensity over the operating temperature range.
3. The decimal point is designed to have the same surface brightness as the segments; therefore, the luminous intensity of the decimal point is .3 times the luminous intensity of the segments, since the area of the decimal point is .3 times the area of the average segment.
4. Leads of the device immersed to 1/16-inches from the body. Maximum device surface temperature is 140°C.
5. For flux removal, Freon TF, Freon TE, isoproponal or water may be used up to their boiling points.

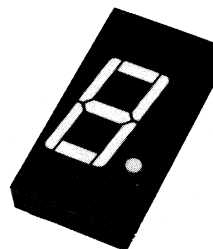
Monsanto

MAN4600A SERIES

0.400-INCH ORANGE SEVEN SEGMENT DISPLAY

FEATURES

- Common anode or common cathode models
- Fast switching—excellent for multiplexing
- Low power consumption
- Bold solid segments that are highly legible
- Solid state reliability—long operating life
- Impact resistant plastic construction
- Directly compatible with integrated circuits
- High brightness with high contrast
- Standard 14 pin dual in-line package configuration
- Wide angle viewing . . . 150°
- Package size and lead configuration is the same as MAN 50A, 70A, 80A and MAN3600A



DESCRIPTION

The MAN4600A Series is available with common anode right hand decimal, common cathode right hand decimal, and common anode overflow (± 1) with right hand decimal. They can be mounted in arrays with 0.400-inch (10.16 mm) center to center spacing.

MODEL NUMBERS

PART NO.	COLOR	DESCRIPTION	PACKAGE DRAWING	PIN-OUT SPECIFICATION
MAN4610A	Orange	Common Anode; Right Hand Decimal	A	A
MAN4630A	Orange	Common Anode; Overflow ± 1 , Rt. Hand Dec.	B	B
MAN4640A	Orange	Common Cathode; Right Hand Decimal	C	C

RECOMMENDED FILTERS

For optimum on and off contrast, one of the following filters or equivalents should be used over the display:

- Panelgraphic Scarlet 65
- Homalite 100-1670

ELECTRO-OPTICAL CHARACTERISTICS (25°C Free Air Temperature Unless Otherwise Specified)

	MIN.	TYP.	MAX.	UNITS	TEST CONDITIONS	
MAN4610A/4630A/4640A	Luminous intensity, Digit Average (See Note 1)	510		μcd	$I_F = 10 \text{ mA}$	
	Decimal point (See Note 3)	250		μcd	$I_F = 10 \text{ mA}$	
	Segment "C" or "D" of MAN4630A	250		μcd	$I_F = 10 \text{ mA}$	
	Peak emission wavelength		630			
	Spectral line half width		40			
	Forward voltage					
	Segment			2.5	V	$I_F = 20 \text{ mA}$
	Decimal point			2.5	V	$I_F = 20 \text{ mA}$
	Dynamic resistance					
	Segment		26		Ω	$I_F = 20 \text{ mA}$
	Decimal point		26		Ω	$I_F = 20 \text{ mA}$
	Capacitance					
	Segment		35		pF	$V = 0$
	Decimal point		35		pF	$V = 0$
	Reverse current					
Segment			100	μA	$V_R = 5.0 \text{ V}$	
Decimal point			100	μA	$V_R = 5.0 \text{ V}$	

ABSOLUTE MAXIMUM RATINGS

	MAN4610A/4640A	MAN4630A
Power dissipation @ 25°C ambient	400 mW	250 mW
Derate linearly from 25°C	-6.7 mW/°C	-4.2 mW/°C
Storage and operating temperature	-40°C to 85°C	-40°C to 85°C
Continuous forward current		
Total	160 mA	100 mA
Per segment	20 mA	20 mA
Decimal point	20 mA	20 mA
Reverse voltage		
Per segment	5.0 V	3.0 V
Decimal point	5.0 V	3.0 V
Solder time @ 260°C (Note 4 and 5)	5 sec	5 sec

TYPICAL THERMAL CHARACTERISTICS

Thermal resistance junction to free air Φ_{JA}	160°C/W
Wavelength temperature coefficient (case temp)	1.0 Å/°C
Forward voltage temperature coefficient	-2.0 mV/°C

TYPICAL CURVES

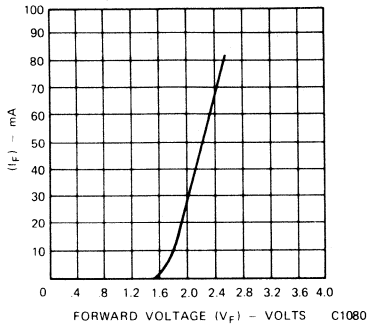


Fig. 1. Forward Current vs. Forward Voltage

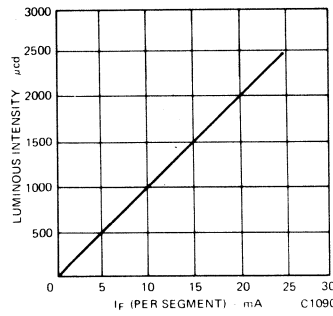


Fig. 2. Luminous Intensity vs. Forward Current

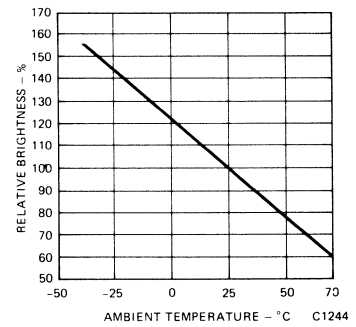


Fig. 3. Luminous Intensity vs. Temperature

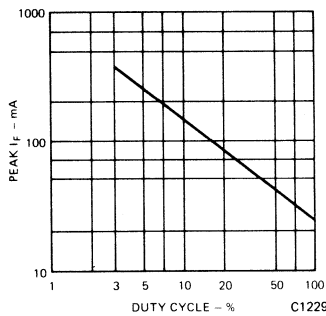


Fig. 4. Max Peak Current vs. Duty Cycle

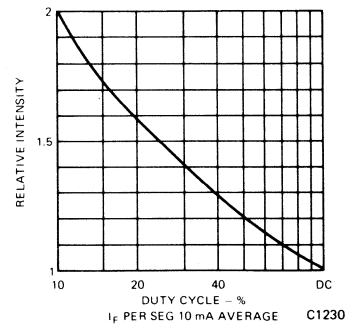
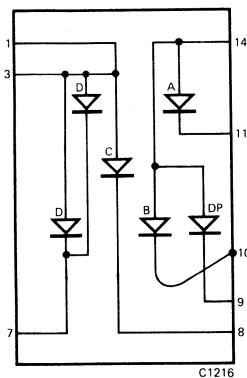


Fig. 5. Luminous Intensity vs. Duty Cycle

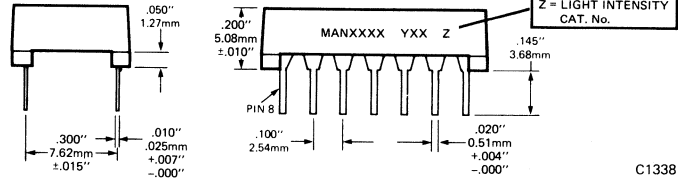
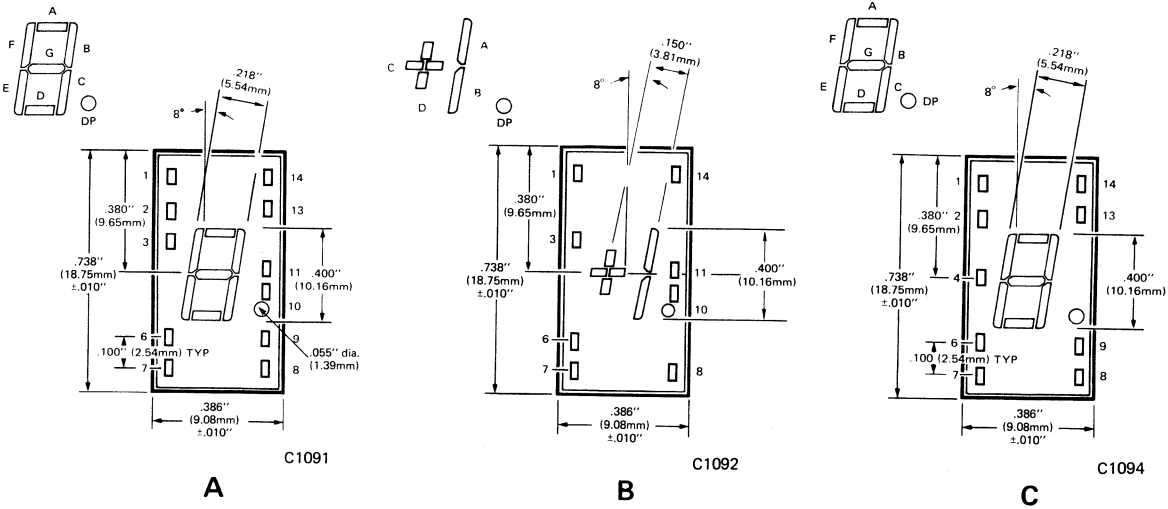
NOTES:

1. The digit average Luminous Intensity is obtained by summing the Luminous Intensity of each segment and dividing the total number of segments. The standard of measurement is the Photo Research Spectra Microcandela Meter corrected for wave length. Intensity will not vary more than $\pm 33.3\%$ between all segments within a digit.
2. The curve in Fig. 3 is normalized to the brightness at 25°C to indicate the relative efficiency over the operating temperature range.
3. The decimal point is designed to have the same surface brightness as the segments; therefore, the luminous intensity of the decimal point is .3 times the luminous intensity of the segments, since the area of the decimal point is .3 times the area of the average segment.
4. Leads of the device immersed to 1/16-inches from the body. Maximum device surface temperature is 140°C.
5. For flux removal, Freon TF, Freon TE, isoproponal or water may be used up to their boiling points.

ELECTRICAL SCHEMATIC—MAN4630



PACKAGE DIMENSIONS



LEADS ARE TIN/LEAD SOLDER DIPPED

C1338

PIN CONNECTIONS

PIN NO.	ELECTRICAL CONNECTIONS		
	A MAN4610A	B MAN4630A	C MAN4640A
1	Cathode A	Anode C, D	Anode F
2	Cathode F	No Pin	Anode G
3	Common Anode	Anode C, D	No Pin
4	No Pin	No Pin	Common Cathode
5	No Pin	No Pin	No Pin
6	NC	NC	Anode E
7	Cathode E	Cathode D	Anode D
8	Cathode D	Cathode C	Anode C
9	Cathode DP	Cathode DP	Anode DP
10	Cathode C	Cathode B	No Pin
11	Cathode G	Cathode A	No Pin
12	No Pin	No Pin	Common Cathode
13	Cathode B	No Pin	Anode B
14	Common Anode	Anode A, B, & DP	Anode A

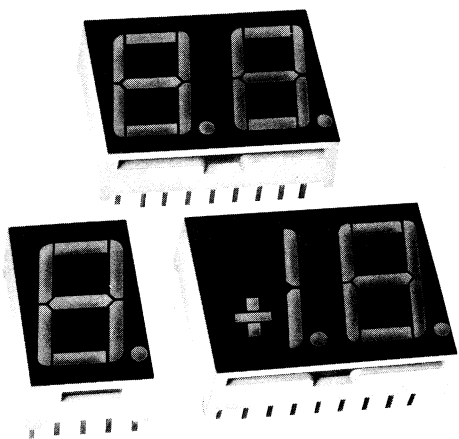
Monsanto

MAN6600 SERIES

0.560-INCH ORANGE HIGH PERFORMANCE DISPLAY

DESCRIPTION

The MAN6600 Series is a family of large digits which includes double and single digits. The series features the sculptured font which minimizes "gappiness" at the segment intersections. Available models include two-digit, one and one-half digits with polarity sign, and single digits. All models have right hand decimal point and are available in common anode or common cathode configuration.



FEATURES

- High performance nitrogen-doped GaAsP on GaP
- Large, easy to read, digits
- Common anode or common cathode models
- Fast switching—excellent for multiplexing
- Low power consumption
- Bold solid segments that are highly legible
- Solid state reliability—long operation life
- Rugged plastic construction
- Directly compatible with integrated circuits
- High brightness with high contrast
- Wide angle viewing . . . 150°
- Low forward voltage
- Two-digit package simplifies alignment & assembly

For industrial and consumer applications such as:

- Digital readout displays
- Instrument panels
- Point-of-sale equipment
- Digital clocks
- TV and radios

MODEL NUMBERS

PART NO.	COLOR	DESCRIPTION	PACKAGE DRAWING	PIN-OUT SPECIFICATION
MAN6610	Orange	2 Digit; Common Anode; Rt. Hand Decimal	A	A
MAN6630	Orange	1½ Digit; Common Anode; Overflow ±1.8. Rt. Hand Decimal	B	B
MAN6640	Orange	2 Digit; Common Cathode; Rt. Hand Decimal	A	C
MAN6650	Orange	1½ Digit; Common Cathode; Overflow ±1.8. Rt. Hand Decimal	B	D
MAN6660	Orange	Single Digit; Common Anode; Rt. Hand Decimal	C	E
MAN6680	Orange	Single Digit; Common Cathode; Rt. Hand Decimal	C	F

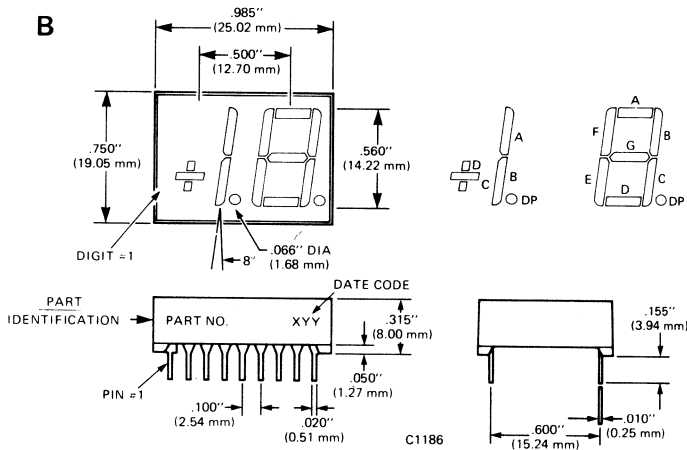
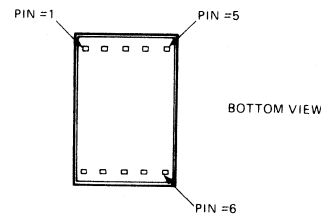
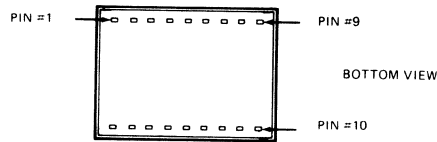
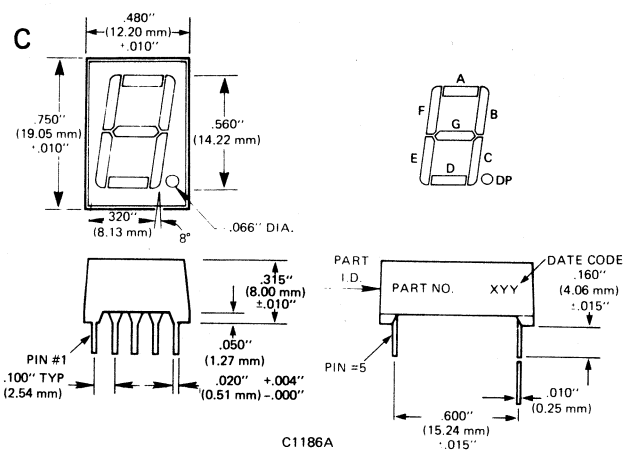
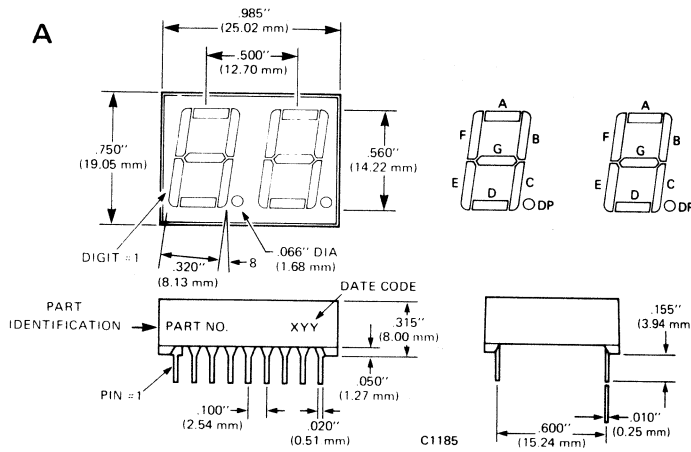
FILTER RECOMMENDATIONS

For optimum on and off contrast, one of the following filters or equivalents should be used over the display:

MAN6600 Series

Panelgraphic Scarlet 65
Homalite 100-1670

PACKAGE DIMENSIONS



NOTE: When placing double digits and single digits together on a board, allowance should be made for 150 mm spacing between the end leads of the double digit and the end leads of the single digit.

PIN CONNECTIONS

PIN NO.	ELECTRICAL CONNECTIONS					
	A MAN6610	B MAN6630	C MAN6640	D MAN6650	E MAN6660	F MAN6680
1	E cathode (No. 1)	C cathode (No. 1)	E anode (No. 1)	C anode (No. 1)	E cathode	E anode
2	D cathode (No. 1)	D cathode (No. 1)	D anode (No. 1)	D anode (No. 1)	D cathode	D anode
3	C cathode (No. 1)	B cathode (No. 1)	C anode (No. 1)	B anode (No. 1)	Common anode	Common cathode
4	DP cathode (No. 1)	DP cathode (No. 1)	DP anode (No. 1)	DP anode (No. 1)	C cathode	C anode
5	E cathode (No. 2)	E cathode (No. 2)	E anode (No. 2)	E anode (No. 2)	DP cathode	DP anode
6	D cathode (No. 2)	D cathode (No. 2)	D anode (No. 2)	D anode (No. 2)	B cathode	B anode
7	G cathode (No. 2)	G cathode (No. 2)	G anode (No. 2)	G anode (No. 2)	A cathode	A anode
8	C cathode (No. 2)	C cathode (No. 2)	C anode (No. 2)	C anode (No. 2)	Common anode	Common cathode
9	DP cathode (No. 2)	DP cathode (No. 2)	DP anode (No. 2)	DP anode (No. 2)	F cathode	F anode
10	B cathode (No. 2)	B cathode (No. 2)	B anode (No. 2)	B anode (No. 2)	G cathode	G anode
11	A cathode (No. 2)	A cathode (No. 2)	A anode (No. 2)	A anode (No. 2)		
12	F cathode (No. 2)	F cathode (No. 2)	F anode (No. 2)	F anode (No. 2)		
13	Digit No. 2 anode	Digit No. 2 anode	Digit No. 2 cathode	Digit No. 2 cathode		
14	Digit No. 1 anode	Digit No. 1 anode	Digit No. 1 cathode	Digit No. 1 cathode		
15	B cathode (No. 1)	A cathode (No. 1)	B anode (No. 1)	A anode (No. 1)		
16	A cathode (No. 1)	No connection	A anode (No. 1)	No connection		
17	G cathode (No. 1)	No connection	G anode (No. 1)	No connection		
18	F cathode (No. 1)	No connection	F anode (No. 1)	No connection		

ABSOLUTE MAXIMUM RATINGS

	MAN6610/6640	MAN6630/6650	MAN6660/6680
Power dissipation @ 25°C ambient	800 mW	650 mW	400 mW
Derate linearly from 25°C	-13 mW/°C	-11 mW/°C	-6.7 mW/°C
Storage and operating temperature	-40°C to 85°C	-40°C to 85°C	-40°C to 85°C
Continuous forward current			
Total	320 mA	260 mA	160 mA
Per segment	20 mA	20 mA	20 mA
Decimal point	20 mA	20 mA	20 mA
Reverse voltage			
Per segment	3.0 V	3.0 V	3.0 V
Decimal point	3.0 V	3.0 V	3.0 V
Solder time @ 260°C (see Note 3 & 4)	5 sec	5 sec	5 sec

ELECTRICAL-OPTICAL CHARACTERISTICS (25°C Free Air Temperature Unless Otherwise Specified)

	MIN.	TYP.	MAX.	UNITS	TEST CONDITIONS
Luminous Intensity, Digit Average (see Note 1)	510			μcd	I _F = 10 mA
Decimal point (see Note 5)	200			μcd	I _F = 10 mA
Segment C or D of "+" (6630/6650)	200			μcd	I _F = 10 mA
Peak emission wavelength		630			
Spectral line half width		40			
Forward voltage					
Segment			2.5	V	I _F = 20 mA
Decimal point			2.5	V	I _F = 20 mA
Dynamic resistance					
Segment		26		Ω	I _F = 20 mA
Decimal point		26		Ω	I _F = 20 mA
Capacitance					
Segment		35		pF	V = 0
Decimal point		35		pF	V = 0
Reverse current					
Segment			100	μA	V _R = 3.0 V
Decimal point			100	μA	V _R = 3.0 V
Ratio I _L			2:1	-	I _F = 10 mA

TYPICAL THERMAL CHARACTERISTICS

Thermal resistance junction to free air Θ_{JA}	160°C/W
Wavelength temperature coefficient (case temp.)	1.0 Å/C
Forward voltage temperature coefficient	-2.0 mV/°C

NOTES

1. The digit average Luminous Intensity is obtained by summing the Luminous Intensity of each segment and dividing the total number of segments. The standard of measurement is the Photo Research Spectra Microcandela Meter corrected for wavelength. Intensity will not vary more than ±33.3% between all segments within a digit.
2. The curve in Fig. 3 is normalized to the brightness at 25°C to indicate the relative efficiency over the operating temperature range.
3. Leads immersed to 1/16" from the body of the device. Maximum unit surface temperature is 140°C.
4. For flux removal, use Freon TF, Freon TE, Isoproponal, or water up to their boiling points.
5. Intensity adjusted for smaller areas of the "+" and decimal points.

TYPICAL CURVES

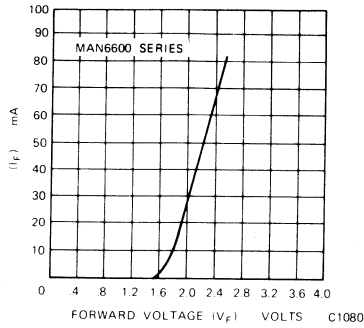


Fig. 1. Forward Current vs. Forward Voltage

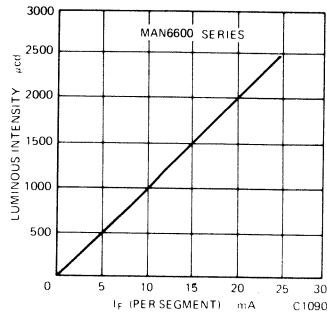


Fig. 2. Luminous Intensity vs. Forward Current

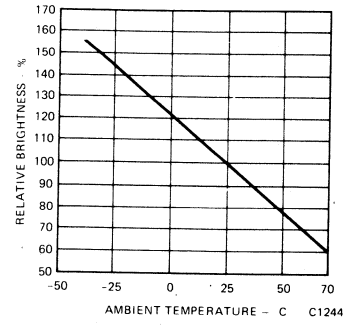


Fig. 3. Luminous Intensity vs. Temperature (see Note 2)

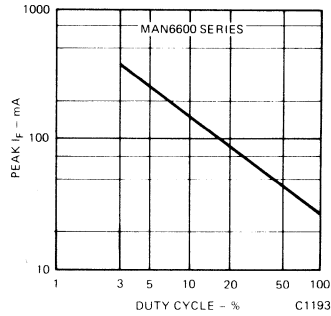


Fig. 4. Max Peak Current vs. Duty Cycle

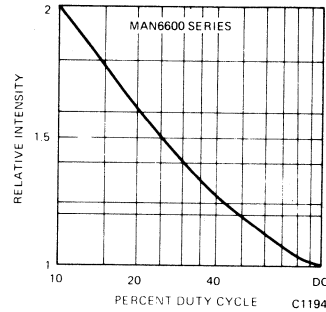
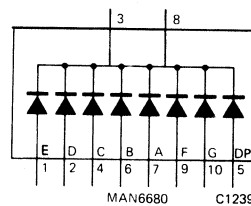
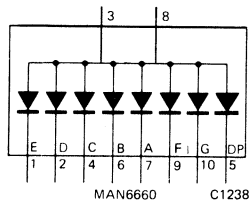
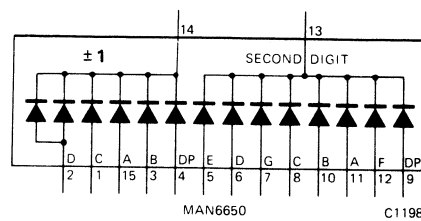
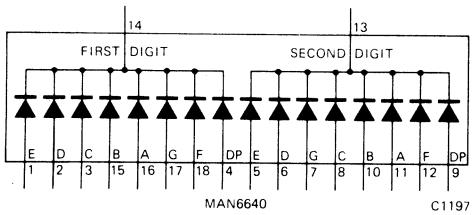
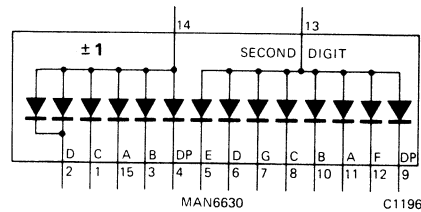
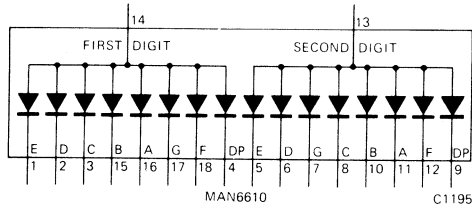


Fig. 5. Luminous Intensity vs. Duty Cycle

INTERNAL CONNECTIONS



Monsanto

MAN6700 SERIES

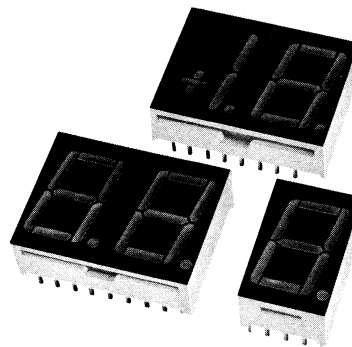
0.560-INCH RED HIGH PERFORMANCE DISPLAY

FEATURES

- High performance GaAsP
- Large, easy to read, digits
- Common anode or common cathode models
- Also available in orange (MAN6600 Series)
- Fast switching—excellent for multiplexing
- Low power consumption
- Bold solid segments that are highly legible
- Solid state reliability—long operation life
- Rugged plastic construction
- Directly compatible with integrated circuits
- High brightness with high contrast
- Wide angle viewing . . . 150°
- Standard double-dip lead configuration
- Low forward voltage
- Two-digit package simplifies alignment & assembly

For industrial and consumer applications such as:

- Digital readout displays
- Instrument panels
- Point-of-sale equipment
- Digital clocks
- TV and radios



DESCRIPTION

The MAN6700 Series is a family of large digits which includes double and single digits. The series features the sculptured font which minimizes "gappiness" at the segment intersections. Available models include two-digit, one and one-half digits with polarity sign, and single digits. All models have right hand decimal point and are available in common anode or common cathode configuration.

MODEL NUMBERS

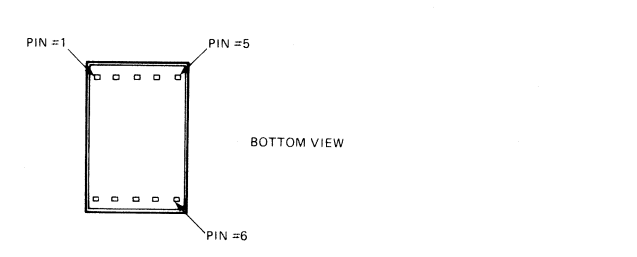
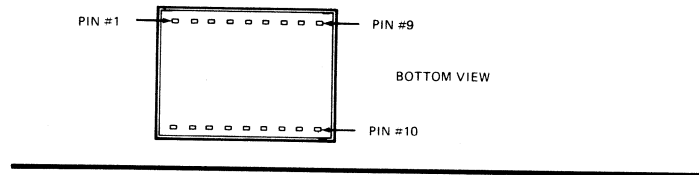
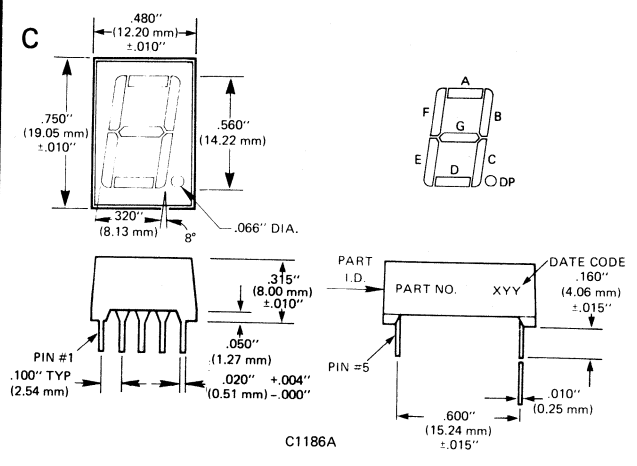
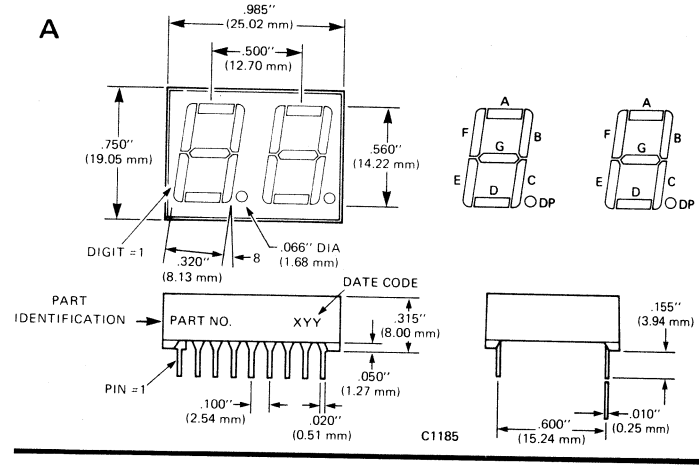
PART NO.	COLOR	DESCRIPTION	PACKAGE DRAWING	PIN-OUT SPECIFICATION
MAN6710	Red	2 Digit; Common Anode; Rt. Hand Decimal	A	A
MAN6730	Red	1½ Digit; Common Anode; Overflow ±1.8 Rt. Hand Decimal	B	B
MAN6740	Red	2 Digit; Common Cathode; Rt. Hand Decimal	A	C
MAN6750	Red	1½ Digit; Common Cathode; Overflow ±1.8 Rt. Hand Decimal	B	D
MAN6760	Red	Single Digit; Common Anode; Rt. Hand Decimal	C	E
MAN6780	Red	Single Digit; Common Cathode; Rt. Hand Decimal	C	F

FILTER RECOMMENDATIONS

For optimum on and off contrast, one of the following filters or equivalents should be used over the display:

MAN6700 Series	Panelgraphic Red 60 Homalite 100 - 1605
----------------	--

PACKAGE DIMENSIONS



NOTE: When placing double digits and single digits together on a board, allowance should be made for 150 mm spacing between the end leads of the double digit and the end leads of the single digit.

PIN CONNECTIONS

PIN NO.	ELECTRICAL CONNECTIONS					
	A MAN6710	B MAN6730	C MAN6740	D MAN6750	E MAN6760	F MAN6780
1	E cathode (No. 1)	C cathode (No. 1)	E anode (No. 1)	C anode (No. 1)	E cathode	E anode
2	D cathode (No. 1)	D cathode (No. 1)	D anode (No. 1)	D anode (No. 1)	D cathode	D anode
3	C cathode (No. 1)	B cathode (No. 1)	C anode (No. 1)	B anode (No. 1)	Common anode	Common cathode
4	DP cathode (No. 1)	DP cathode (No. 1)	DP anode (No. 1)	DP anode (No. 1)	C cathode	C anode
5	E cathode (No. 2)	E cathode (No. 2)	E anode (No. 2)	E anode (No. 2)	DP cathode	DP anode
6	D cathode (No. 2)	D cathode (No. 2)	D anode (No. 2)	D anode (No. 2)	B cathode	B anode
7	G cathode (No. 2)	G cathode (No. 2)	G anode (No. 2)	G anode (No. 2)	A cathode	A anode
8	C cathode (No. 2)	C cathode (No. 2)	C anode (No. 2)	C anode (No. 2)	Common anode	Common cathode
9	DP cathode (No. 2)	DP cathode (No. 2)	DP anode (No. 2)	DP anode (No. 2)	F cathode	F anode
10	B cathode (No. 2)	B cathode (No. 2)	B anode (No. 2)	B anode (No. 2)	G cathode	G anode
11	A cathode (No. 2)	A cathode (No. 2)	A anode (No. 2)	A anode (No. 2)		
12	F cathode (No. 2)	F cathode (No. 2)	F anode (No. 2)	F anode (No. 2)		
13	Digit No. 2 anode	Digit No. 2 anode	Digit No. 2 cathode	Digit No. 2 cathode		
14	Digit No. 1 anode	Digit No. 1 anode	Digit No. 1 cathode	Digit No. 1 cathode		
15	B cathode (No. 1)	A cathode (No. 1)	B anode (No. 1)	A anode (No. 1)		
16	A cathode (No. 1)	No connection	A anode (No. 1)	No connection		
17	G cathode (No. 1)	No connection	G anode (No. 1)	No connection		
18	F cathode (No. 1)	No connection	F anode (No. 1)	No connection		

ABSOLUTE MAXIMUM RATINGS

	MAN6710/6740	MAN6730/6750	MAN6760/6780
Power dissipation @ 25°C ambient	800 mW	650 mW	400 mW
Derate linearly from 25°C	-13 mW/°C	-10.5 mW/°C	-6.7 mW/°C
Storage and operating temperature	-40°C to 85°C	-40°C to 85°C	-40°C to 85°C
Continuous forward current			
Total	320 mA	260 mA	160 mA
Per segment	20 mA	20 mA	20 mA
Decimal point	20 mA	20 mA	20 mA
Reverse voltage			
Per segment	5.0 V	5.0 V	5.0 V
Decimal point	5.0 V	5.0 V	5.0 V
Solder time @ 260°C (see Note 3 & 4)	5 sec	5 sec	5 sec

ELECTRICAL-OPTICAL CHARACTERISTICS (25°C Free Air Temperature Unless Otherwise Specified)

	MIN.	TYP.	MAX.	UNITS	TEST CONDITIONS
Luminous intensity, Digit Average (see Note 1)	125			μcd	I _F = 10 mA
Decimal point (see Note 5)	55			μcd	I _F = 10 mA
Segment C or D of "+" (6730/6750) (note 5)	35			μcd	I _F = 10 mA
Peak emission wavelength		650		nm	
Spectral line half width		20		nm	
Forward voltage					
Segment			2.0	V	I _F = 20 mA
Decimal point			2.0	V	I _F = 20 mA
Dynamic resistance					
Segment		2		Ω	1 _{PK} = 100 mA
Decimal point		2		Ω	1 _{PK} = 100 mA
Capacitance					
Segment		35		pF	V = 0
Decimal point		35		pF	V = 0
Reverse current					
Segment			100	μA	V _R = 5.0 V
Decimal point			100	μA	V _R = 5.0 V
Segment C or D of "+" (6730/6750)			100	μA	V _R = 5.0 V

TYPICAL THERMAL CHARACTERISTICS

Thermal resistance junction to free air Θ_{JA}	160°C/W
Wavelength temperature coefficient (case temp.)	3.0 Å/°C
Forward voltage temperature coefficient	-2.0 mV/°C

NOTES

1. The digit average Luminous Intensity is obtained by summing the Luminous Intensity of each segment and dividing the total number of segments. The standard of measurement is the Photo Research Spectra Microcandela Meter corrected for wavelength. Intensity will not vary more than ±33.3% between all segments within a digit.
2. The curve in Fig. 3 is normalized to the brightness at 25°C to indicate the relative efficiency over the operating temperature range.
3. Leads immersed to 1/16" from the body of the device. Maximum unit surface temperature is 140°C.
4. For flux removal, use Freon TF, Freon TE, Isoproponal, or water up to their boiling points.
5. Intensity adjusted for smaller areas of the "+" and decimal points.
6. Pins 3 and 8 on MAN6760 and MAN6780 are redundant anodes or cathodes.

TYPICAL CURVES

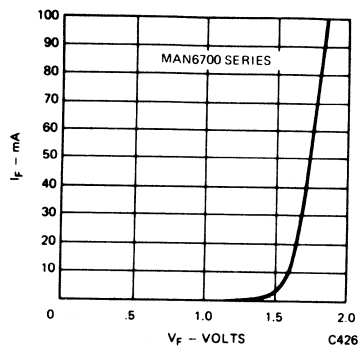


Fig. 1. Forward Current vs. Forward Voltage

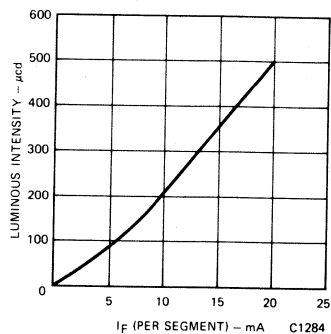


Fig. 2. Luminous Intensity vs. Forward Current

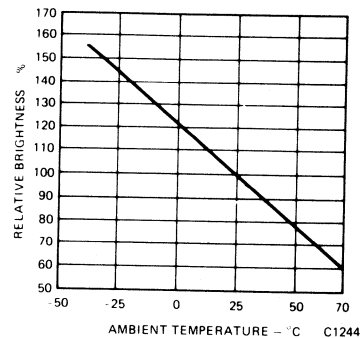


Fig. 3. Luminous Intensity vs. Temperature (See Note 2)

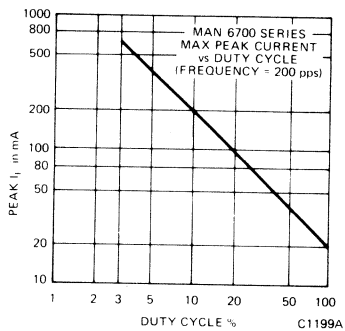


Fig. 4. Max Peak Current vs. Duty Cycle

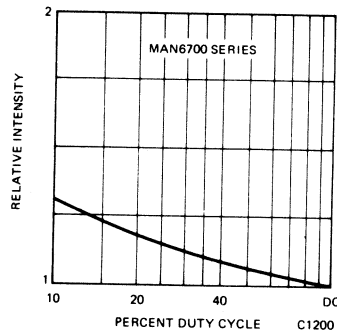
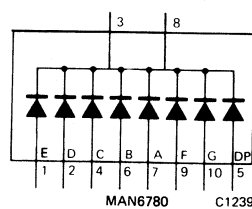
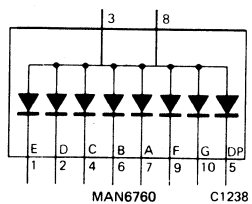
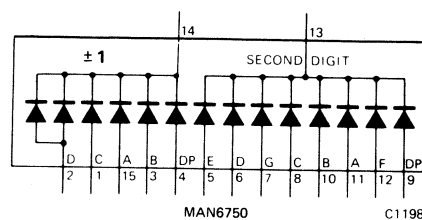
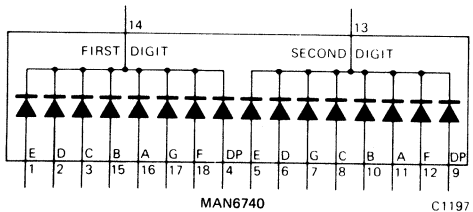
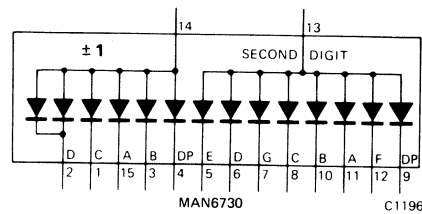
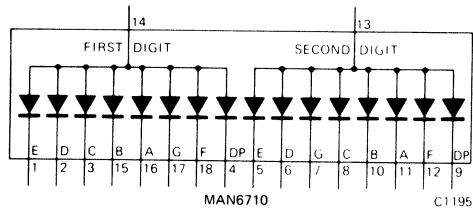


Fig. 5. Luminous Intensity vs. Duty Cycle

INTERNAL CONNECTIONS



6 OPTOISOLATORS

Optoisolators

QUICK REFERENCE CHART

		MODEL NO.	PACKAGE TYPE	CURRENT TRANSFER RATIO	MIN. DC ISOLATION VOLTAGE	MIN. OUTPUT VOLTAGE RATING (BV _{CEO})	MAX. T _{ON} , T _{OFF} R _L = 100 Ω (μsec)
TRANSISTOR OUTPUT	DESIGNER SERIES						
		†MCT271	6 LEAD PLASTIC DIP	45-90%	3150	30 V	7
		†MCT272	6 LEAD PLASTIC DIP	75-150%	3150	30 V	10
		†MCT273	6 LEAD PLASTIC DIP	125-250%	3150	30 V	20
		†MCT274	6 LEAD PLASTIC DIP	225-400%	3150	30 V	25
		†MCT275	6 LEAD PLASTIC DIP	70-210%	3150	80 V	15
		†MCT276	6 LEAD PLASTIC DIP	15-60%	3150	30 V	2.5
		†MCT277	6 LEAD PLASTIC DIP	100% MIN.	1750	30 V	15
		†MCT2E	6 LEAD PLASTIC DIP	20% MIN.	3550	30 V	-
	INDUSTRY STANDARD						
		MCT2	6 LEAD PLASTIC DIP	20% MIN.	1500 V	30 V	
		MCT210	6 LEAD PLASTIC DIP	150% MIN.	4000 V	30 V	
		MCT26	6 LEAD PLASTIC DIP	6% MIN.	1500 V	30 V	
		4N25	6 LEAD PLASTIC DIP	20% MIN.	2500 V	30 V	
		4N26	6 LEAD PLASTIC DIP	20% MIN.	1500 V	30 V	
	4N27	6 LEAD PLASTIC DIP	10% MIN.	1500 V	30 V		
	4N28	6 LEAD PLASTIC DIP	10% MIN.	500 V	30 V		
	4N35	6 LEAD PLASTIC DIP	100% MIN.	3550 V	30 V	10	
	4N36	6 LEAD PLASTIC DIP	100% MIN.	2500 V	30 V	10	
	4N37	6 LEAD PLASTIC DIP	100% MIN.	1500 V	30 V	10	
DUAL CHANNEL							
	MCT6	8 LEAD PLASTIC DIP	20% MIN.	1500 V	30 V		
	MCT66	8 LEAD PLASTIC DIP	6% MIN.	1500 V	30 V		
HERMETIC PACKAGE							
	MCT4	TO-46 METAL CAN	15% MIN.	1000 V	30 V		
	MCT4R*	TO-46 METAL CAN	15% MIN.	1000 V	30 V		
*Reliability conditioned to MIL-STD-883, Method 5005/B, 100% pre-conditioning.							
DARLINGTON OUTPUT	MCA230	6 LEAD PLASTIC DIP	100% MIN.	1500 V	30 V		
	MCA231	6 LEAD PLASTIC DIP	200% MIN.	1500 V	30 V		
	MCA255	6 LEAD PLASTIC DIP	100% MIN.	1500 V	55 V		
	4N29	6 LEAD PLASTIC DIP	100% MIN.	2500 V	30 V		
	4N30	6 LEAD PLASTIC DIP	100% MIN.	1500 V	30 V		
	4N31	6 LEAD PLASTIC DIP	50% MIN.	1500 V	30 V		
	4N32	6 LEAD PLASTIC DIP	500% MIN.	2500 V	30 V		
	4N33	6 LEAD PLASTIC DIP	500% MIN.	1500 V	30 V		
MODEL NO.	PACKAGE TYPE	DC ISOLATION VOLTAGE	FORWARD BLOCKING VOLTAGE (V _{DRRM})	MAX. TURN-ON CURRENT (I _F)			
SCR OUTPUT	MCS2	6 LEAD PLASTIC DIP	1500 V	200 V	14.0 mA		
	†MCS2400	6 LEAD PLASTIC DIP	1500 V	400 V	14.0 mA		
	MCS6200‡	8 LEAD PLASTIC DIP	1500 V	200 V	14.0 mA		
	MCS6201‡	8 LEAD PLASTIC DIP	2500 V	200 V	14.0 mA		
	‡2 SCR's (CONNECTED ANODE TO CATHODE)						
MODEL NO.	OUTPUT FORMAT	PACKAGE TYPE	MIN. DC ISOLATION VOLTAGE	MIN. BINARY DATA RATE (BDR)	MAX. TRIGGER (I _F)	TYP. HYSTERESIS (ΔI _F)	
HIGH SPEED LOGIC	MCL600	LOGIC GATE TOTEM POLE	8 LEAD PLASTIC DIP	2000 V	0.1 MHz	5.0 mA	1.0 mA
	MCL610	LOGIC GATE TOTEM POLE	8 LEAD PLASTIC DIP	2000 V	1.0 MHz	15 mA	5.0 mA

†U.L. RECOGNIZED PRODUCT

Monsanto

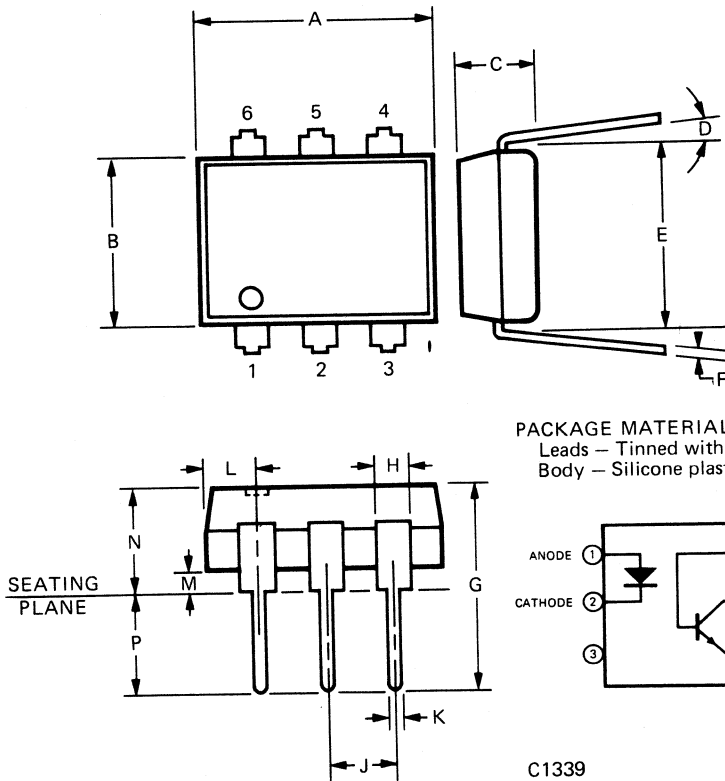
4N25 4N26 4N27 4N28

PHOTOTRANSISTOR OPTOISOLATORS

PRODUCT DESCRIPTION

The 4N25, 4N26, 4N27 and 4N28 series of optoisolators have a NPN silicon planar phototransistor optically coupled to a gallium arsenide diode. Each is mounted in a six-lead plastic DIP package.

PACKAGE DIMENSIONS



PACKAGE MATERIALS:
Leads - Tinned with 60/40 tin lead
Body - Silicone plastic

FEATURES & APPLICATIONS

- AC line/digital logic isolator
- Digital logic/digital logic isolator
- Telephone/telegraph line receiver
- Twisted pair line receiver
- High frequency power supply feedback control
- Relay contact monitor
- Power supply monitor
- Small package size and low cost
- High isolation voltage
- Excellent frequency response

SYMBOL	INCH MAX.	MM. MAX.	NOTES
A	.365	9.27	
B	.270	6.73	
C	.130	3.18	
D	15°	15°	
E	.300 Ref	7.62 Ref	1
F	.014	0.36	
G	.325	8.26	
H	.070	1.78	
J	.110	2.79	
K	.022	0.56	
L	.085	2.16	2
M			3
N	.175	4.45	4
P			3

NOTES

1. Installed position of lead centers
2. Four places
3. Overall installed position
4. These measurements are made from the seating plane

ABSOLUTE MAXIMUM RATINGS

*Storage temperature	-55°C to 150°C
*Operating temperature at junction	-55°C to 100°C
*Lead temperature (soldering, 10 sec)	260°C
*Total package power dissipation at 25°C ambient (LED plus detector)	250 mW
*Derate linearly from 25°C	3.3 mW/°C
Input diode		
*Forward DC current continuous	80 mA
*Reverse voltage	3.0 V
*Peak forward current (300 μs, 2% duty cycle)	3.0 A
*Power dissipation at 25°C ambient	150 mW
*Derate linearly from 25°C	2.0 mW/°C
Output transistor		
*Collector emitter voltage (BV _{CEO})	30 V
*Collector base voltage (BV _{CBO})	70 V
*Emitter collector voltage (BV _{ECO})	7 V
*Power dissipation at 25°C ambient	150 mW
*Derate linearly from 25°C	2.0 mW/°C

*Indicates JEDEC Registered Data.

ELECTRO-OPTICAL CHARACTERISTICS (25°C Free Air Temperature Unless Otherwise Specified)

CHARACTERISTICS	SYMBOL	MIN.	TYP.	GUAR. MAX.	UNITS	TEST CONDITIONS
Input diode						
*Forward voltage	V_F		1.20	1.50	V	$I_F = 50 \text{ mA}$
Capacitance	C		150		pF	$V_R = 0 \text{ V}, f = 1 \text{ MHz}$
*Reverse leakage current			.05	100	μA	$V_R = 3.0 \text{ V}, R_L = 1.0 \text{ M}\Omega$
Output transistor						
DC forward current gain	h_{FE}		250			$V_{CE} = 5 \text{ V}, I_C = 500 \mu\text{A}$
*Collector to emitter breakdown voltage	BV_{CEO}	30	65		V	$I_C = 1.0 \text{ mA}, I_B = 0$
*Collector to base breakdown voltage	BV_{CBO}	70	165		V	$I_C = 100 \mu\text{A}, I_E = 0$
*Emitter to collector breakdown voltage	BV_{ECO}	7	14		V	$I_E = 100 \mu\text{A}, I_B = 0$
*Collector to emitter leakage current (4N25, 4N26, 4N27)	I_{CEO}		3.5	50	nA	$V_{CE} = 10 \text{ V}$ Base Open
*Collector to emitter leakage current (4N28)				100	nA	
*Collector to base leakage current	I_{CBO}		0.1	20	nA	$V_{CB} = 10 \text{ V}$ Emitter Open
Coupled						
*Collector output current (a) (4N25, 4N26) (4N27, 4N28)	I_C	2.0 1.0	5.0 3.0	— —	mA	$V_{CE} = 10 \text{ V}, I_F = 10 \text{ mA}, I_B = 0$
*Isolation voltage (b) (4N25) (4N26, 4N27) (4N28)	V_{ISO}	2500 1500 500	— — —	— — —	V V V	Peak Peak Peak
Isolation resistance (b)			10"		Ω	$V = 500 \text{ VDC}$
*Collector-emitter saturation	$V_{CE(SAT)}$		0.2	0.5	V	$I_C = 2.0 \text{ mA}, I_F = 50 \text{ mA}$
Isolation capacitance (b)			1.3		pF	$V = 0, f = 1.0 \text{ MHz}$
Bandwidth (c) (also see note 2)	B_W		300		kHz	$I_C = 2.0 \text{ mA}, R_L = 100 \Omega$ (Figure 12)

*Indicates JEDEC Registered Data.

(a) Pulse Test: Pulse Width = 300 μs , Duty Cycle $\leq 2.0\%$

(b) For this test LED pins 1 and 2 are common and Phototransistor pins 4, 5 and 6 are common.

(c) If adjusted to yield $I_C = 2 \text{ mA}$ and $i_c = 0.7 \text{ mA RMS}$; Bandwidth referenced to 10 kHz.

SWITCHING TIMES		TYP.	UNITS	TEST CONDITIONS
Non-saturated				
Collector				
Delay time	t_d	0.5	μs	$R_L = 100 \Omega, I_C = 2 \text{ mA}, V_{CC} = 10 \text{ V}$ (Fig. 14)
Rise time	t_r	2.5	μs	
Fall time	t_f	2.6	μs	
Non-saturated				
Collector				
Delay time	t_d	2.0	μs	$R_L = 1\text{k}\Omega, I_C = 2 \text{ mA}, V_{CC} = 10 \text{ V}$ (Fig. 14)
Rise time	t_r	15	μs	
Fall time	t_f	15	μs	
Saturated				
t_{on} (from 5 V to 0.8 V)	$t_{on(SAT)}$	5	μs	$R_L = 2\text{k}\Omega, I_F = 15 \text{ mA}, V_{CC} = 5 \text{ V}$ $R_B = \text{Open}$ (Circuit No. 1)
t_{off} (from SAT to 2.0 V)	$t_{off(SAT)}$	25	μs	
Saturated				
t_{on} (from 5 V to 0.8 V)	$t_{on(SAT)}$	5	μs	$R_L = 2\text{k}\Omega, I_F = 20 \text{ mA}, V_{CC} = 5 \text{ V}$ $R_B = 100\text{k}\Omega$ (Circuit No. 1)
t_{off} (from SAT to 2.0 V)	$t_{off(SAT)}$	18	μs	
Non-saturated				
Base — Collector photo diode				
Rise time	t_r	175	ns	$R_L = 1\text{k}\Omega, V_{CB} = 10 \text{ V}$
Fall time	t_f	175	ns	

TYPICAL ELECTRO-OPTICAL CHARACTERISTIC CURVES

(25°C Free Air Temperature Unless Otherwise Specified)

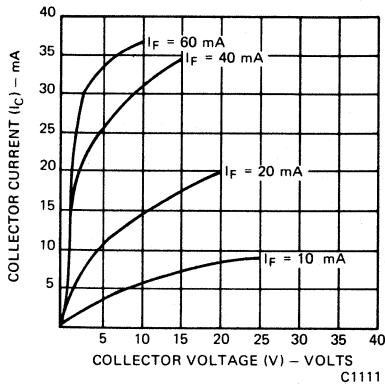


Fig. 1. Collector Current vs. Collector Voltage

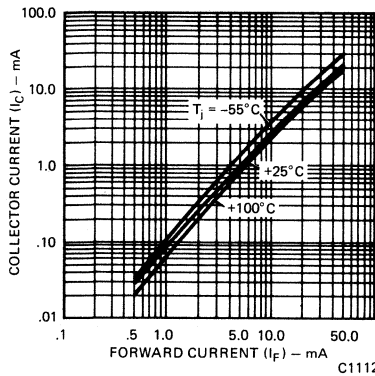


Fig. 2. Collector Current vs. Forward Current

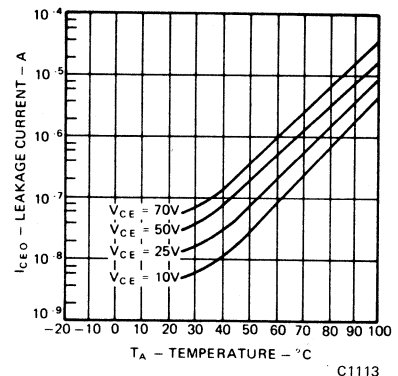


Fig. 3. Dark Current vs. Temperature

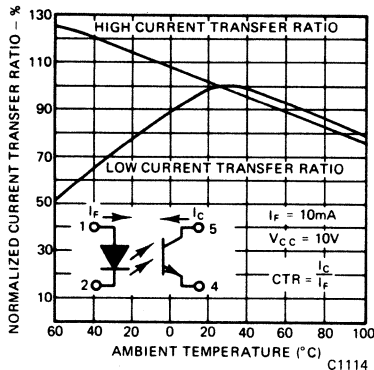


Fig. 4. Current Transfer Ratio vs. Temperature

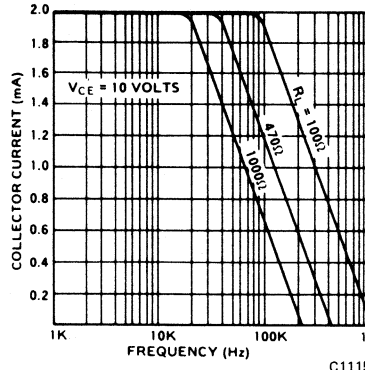


Fig. 5. Collector Current vs. Frequency (see Fig. 12 for circuit)

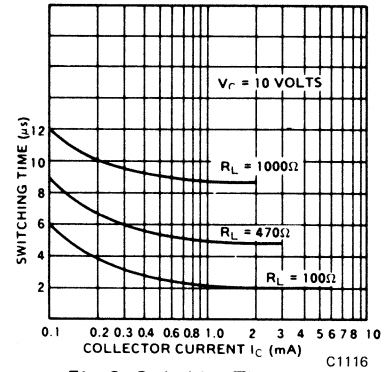
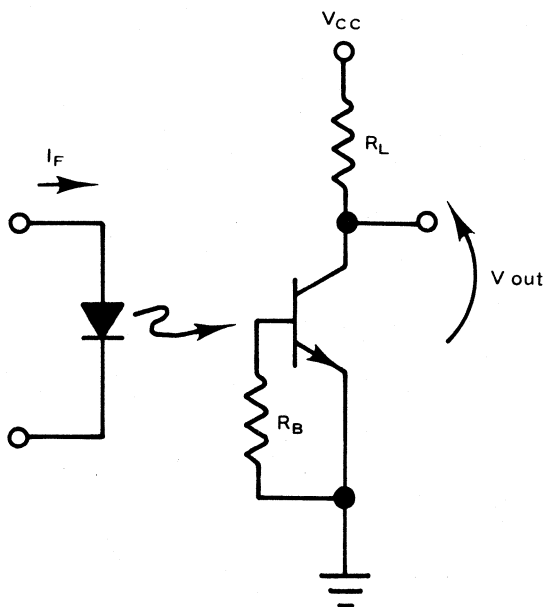


Fig. 6. Switching Time vs. Collector Current (see Fig. 13 for Circuit)



Circuit 1

C1110

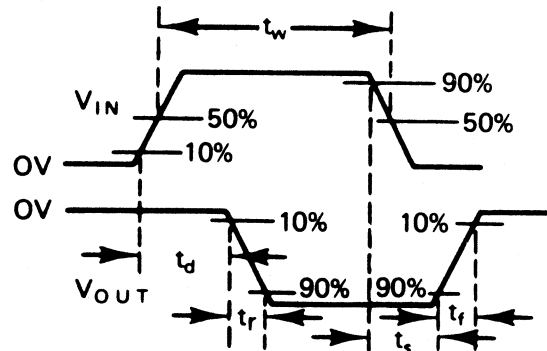


Fig. 7. Pulse Test Definition (Note 3)

C1117

TYPICAL ELECTRO-OPTICAL CHARACTERISTIC CURVES (Cont'd)

(25°C Free Air Temperature Unless Otherwise Specified)

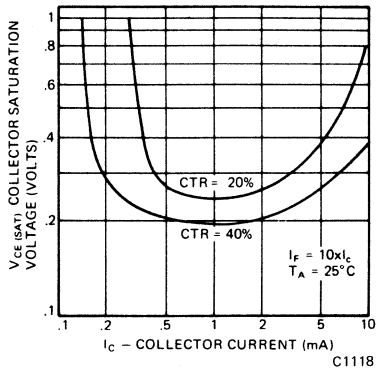


Fig. 8. Saturation Voltage vs. Collector Current

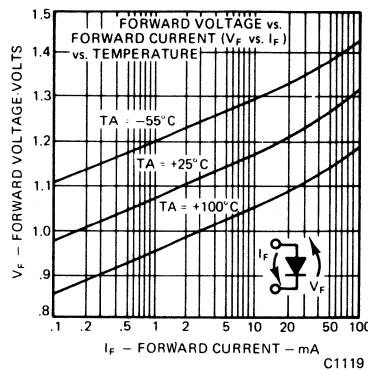


Fig. 9. Forward Voltage vs. Forward Current

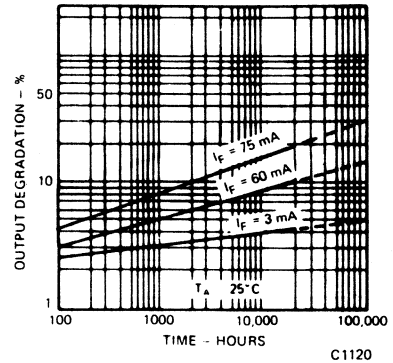


Fig. 10. Lifetime vs. Forward Current

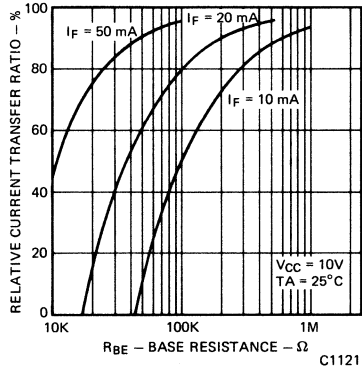


Fig. 10. Sensitivity vs. Base Resistance

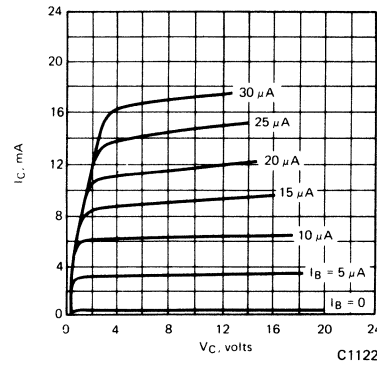


Fig. 11. Detector h_{FE} Curves

OPERATING SCHEMATICS

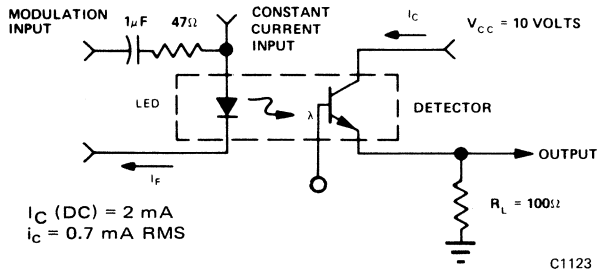


Fig. 12. Modulation Circuit Used to Obtain Output vs. Frequency Plot

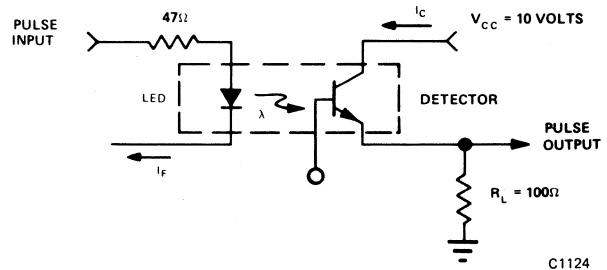


Fig. 13. Circuit Used to Obtain Switching Time vs. Collector Current Plot

NOTES

1. The current transfer ratio (I_C/I_F) is the ratio of the detector collector current to the LED input current with V_{CE} at 10 volts.
2. The frequency at which i_c is 3dB down from the 10 kHz value.
3. Rise time (t_r) is the time required for the collector current to increase from 10% of its final value to 90%. Fall time (t_f) is the time required for the collector current to decrease from 90% of its initial value to 10%.

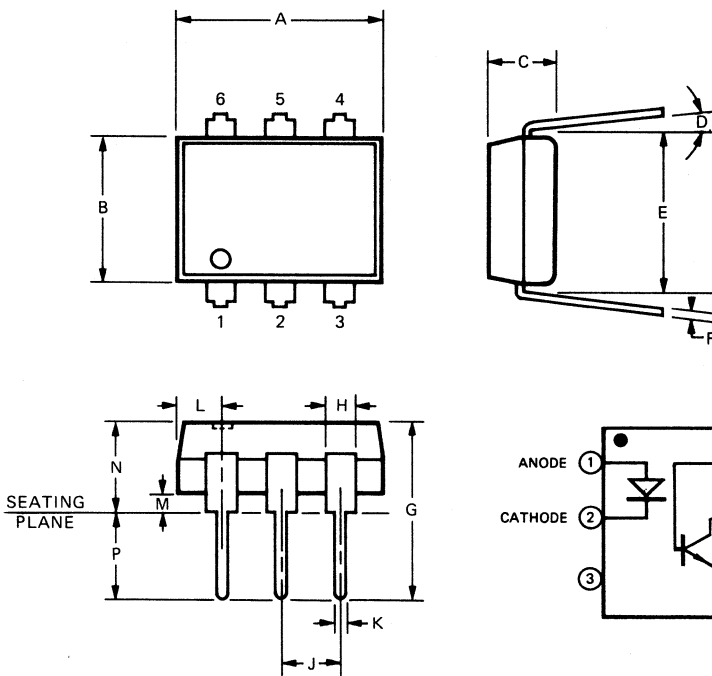
Monsanto

4N29 4N30 4N31 4N32 4N33 PHOTODARLINGTON OPTOISOLATOR

PRODUCT DESCRIPTION

The 4N29, 4N30, 4N31, 4N32 and 4N33 have a gallium arsenide infrared emitter optically coupled to a silicon planar photo-darlington. Each unit is sealed in a 6-lead plastic DIP package.

PACKAGE DIMENSIONS



PACKAGE MATERIALS:
Leads - Tinned with 60/40 tin lead
Body - Silicone plastic

C1339

FEATURES & APPLICATIONS

- Fast operate time — 10 μ s
- High isolation resistance — $10^{11} \Omega$
- High dielectric strength, input to output — 2500 V min. 4N29, 4N32; 1500 V min. 4N30, 4N31, 4N33
- Low coupling capacitance — 1.0 pF
- Convenient package — plastic dual-in-line
- Long lifetime, solid state reliability
- Low weight — 0.4 grams

SYMBOL	INCH MAX.	MM. MAX.	NOTES
A	.365	9.27	
B	.270	6.73	
C	.130	3.18	
D	15°	15°	
E	.300 Ref	7.62 Ref	1
F	.014	0.36	
G	.325	8.26	
H	.070	1.78	
J	.110	2.79	
K	.022	0.56	
L	.085	2.16	2
M			3
N	.175	4.45	4
P			3

NOTES

1. Installed position of lead centers
2. Four places
3. Overall installed position
4. These measurements are made from the seating plane

ABSOLUTE MAXIMUM RATINGS $T_A = 25^\circ\text{C}$ (Unless otherwise specified)

- *Storage Temperature -55°C to 150°C
- *Operating Temperature at Junction -55°C to 100°C
- *Lead Soldering time @ 260°C 10 seconds
- *Total power dissipation @ 25°C ambient 250 mW
- *Derate linearly from 25°C 3.3 mW/ $^\circ\text{C}$

LED (GaAs Diode)

- *Power dissipation @ 25°C ambient 150 mW
- *Derate linearly from 55°C 2 mW/ $^\circ\text{C}$
- *Continuous forward current 80 mA
- Reverse current 10 mA
- *Peak forward current (300 μ sec, 2% duty cycle) .. 3.0 A

*Indicated JEDEC Registered data.

DETECTOR (Silicon Photo Darlington Transistor)

- *Power dissipation @ 25°C ambient 150 mW
- *Derate linearly from 25°C 2.0 mW/ $^\circ\text{C}$
- *Collector-emitter breakdown voltage (BV_{CEO}) 30 V
- *Collector-base breakdown voltage (BV_{CBO}) 50 V
- Emitter-base breakdown voltage (BV_{EBO}) 8.0 V
- *Emitter-collector breakdown voltage (BV_{ECO}) 5 V

ELECTRO-OPTICAL CHARACTERISTICS (25°C Free Air Temperature Unless Otherwise Specified)

CHARACTERISTIC	SYMBOL	MIN.	TYP.	MAX.	UNIT	TEST CONDITION
LED CHARACTERISTICS (T _A = 25°C unless otherwise noted)						
*Reverse leakage current	I _R		0.05	100	μA	V _R = 3.0 V
*Forward voltage	V _F		1.2	1.5	Volts	I _F = 50 mA
Capacitance	C		150		pF	V _R = 0 V, f = 1.0 MHz
PHOTOTRANSISTOR CHARACTERISTICS (T _A = 25°C and I _F = 0 unless otherwise noted)						
*Collector-emitter dark current	I _{CEO}			100	nA	V _{CE} = 10 V, base open
*Collector-base breakdown voltage	BV _{CBO}	30			Volts	I _C = 100 μA, I _E = 0
*Collector-emitter breakdown voltage	BV _{CEO}	30			Volts	I _C = 100 μA, I _B = 0
*Emitter-collector breakdown voltage	BV _{EBO}	5.0			Volts	I _E = 100 μA, I _B = 0
DC current gain	h _{FE}		5000			V _{CE} = 5.0 V, I _C = 500 μA
COUPLED CHARACTERISTICS (T _A = 25°C unless otherwise noted)						
*Collector output current (1)	I _C					
4N32, 4N33		50			mA	V _{CE} = 10 V, I _F = 10 mA, I _B = 0
4N29, 4N30		10			mA	V _{CE} = 10 V, I _F = 10 mA, I _B = 0
4N31		5.0			mA	V _{CE} = 10 V, I _F = 10 mA, I _B = 0
*Isolation voltage (2)	V _{ISO}	2500			VDC	
4N29, 4N32		1500			VDC	
4N30, 4N31, 4N33					VDC	
Isolation Resistance (2)	R _{ISO}		10 ¹¹		Ohms	V = 500 VDC
*Collector-emitter saturation voltage (1)	V _{CE(SAT)}					
4N31				1.2	Volts	I _C = 2.0 mA, I _F = 8.0 mA
4N29, 4N30, 4N32, 4N33				1.0	Volts	I _C = 2.0 mA, I _F = 8.0 mA
Isolation capacitance (2)			0.8		pF	V = 0, f = 1.0 MHz
Bandwidth (3) (Test Circuit # 1)			30		kHz	
SWITCHING CHARACTERISTICS (Test Circuit # 2)						
Turn-on time (Note 3)	t _{ON}		0.6	5.0	μs	I _C = 50 mA, I _F = 200 mA, V _{CC} = 10 V
Turn-off time (Note 3)	t _{OFF}		17	40	μs	I _C = 50 mA, I _F = 200 mA, V _{CC} = 10 V
4N29, 4N30, 4N31			45	100	μs	
4N32, 4N33						

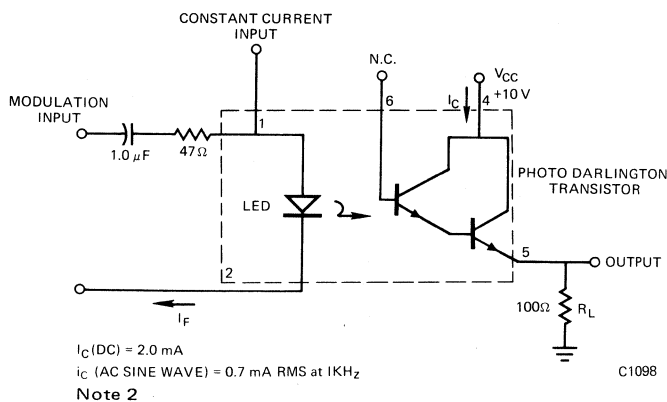
*Indicates JEDEC Registered Data.

(1) Pulse test: pulse width = 300 μs, duty cycle ≤ 2.0%

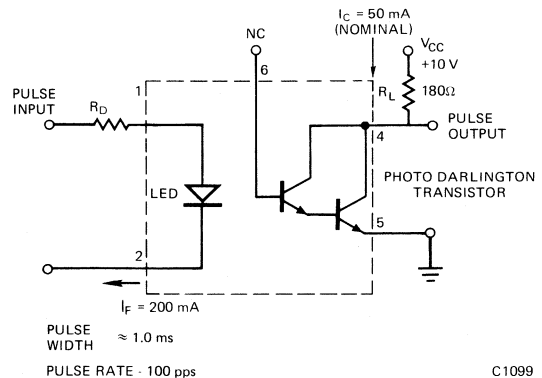
(2) For this test LED pins 1 and 2 are common and phototransistor pins 4, 5 and 6 are common.

(3) I_F adjusted to I_C = 2.0 mA and i_c = 0.7 mA RMS.

(4) t_d and t_r are inversely proportional to the amplitude of I_F; t_s and t_f are not significantly affected by I_F.



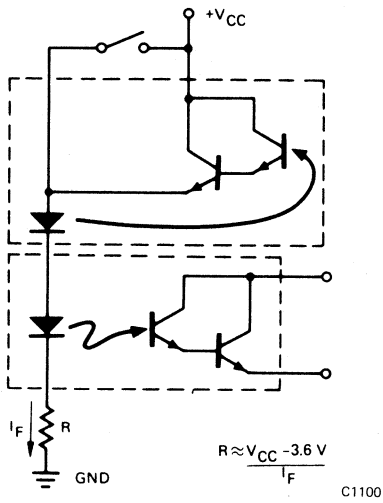
FREQUENCY RESPONSE TEST CIRCUIT #1



SWITCHING TIME TEST CIRCUIT #2

APPLICATION INFORMATION

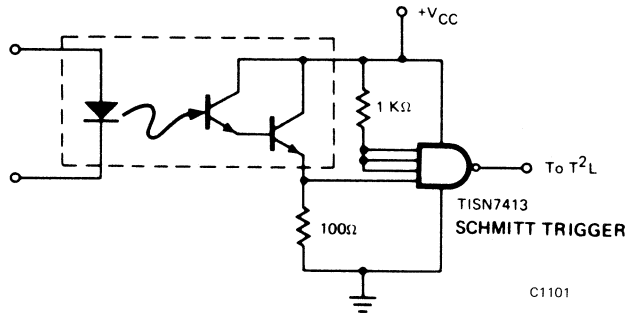
LATCH



NOT APPLICABLE TO 4N31

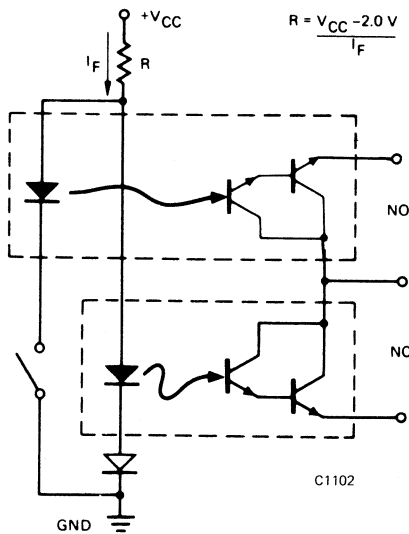
C1100

T²L LOGIC ISOLATION



C1101

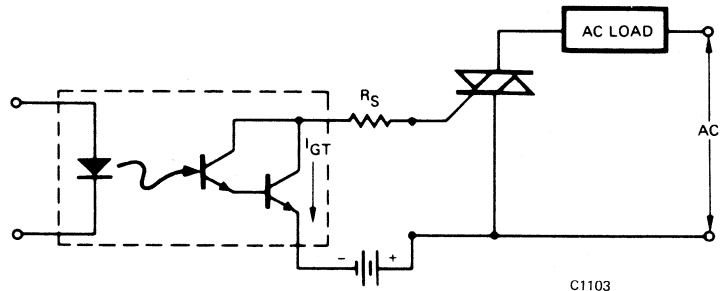
FORM C CONTACT



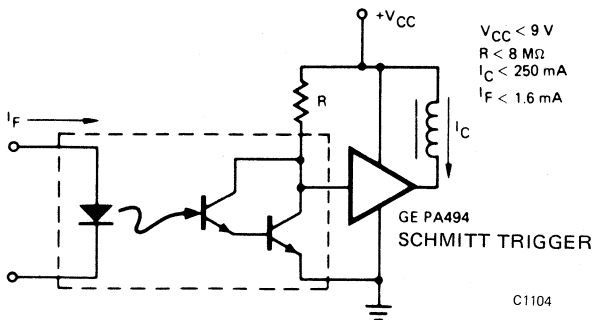
NOT APPLICABLE TO 4N31

C1102

TRIAC TRIGGER

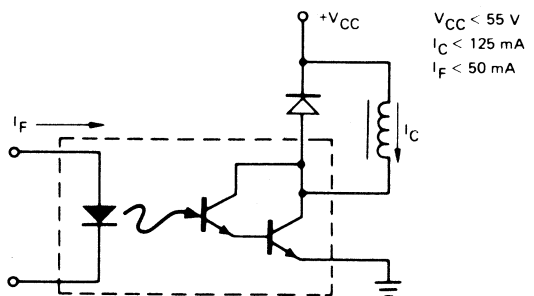


OPERATING A RELAY COIL



C1104

$V_{CC} < 9 V$
 $R < 8 M\Omega$
 $I_C < 250 mA$
 $I_F < 1.6 mA$



C1104

$V_{CC} < 55 V$
 $I_C < 125 mA$
 $I_F < 50 mA$

TYPICAL ELECTRO-OPTICAL CHARACTERISTIC CURVES

(25°C Free Air Temperature Unless Otherwise Specified)

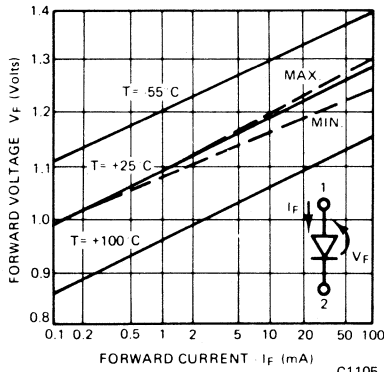


Fig. 1. Forward Voltage Drop vs. Forward Current

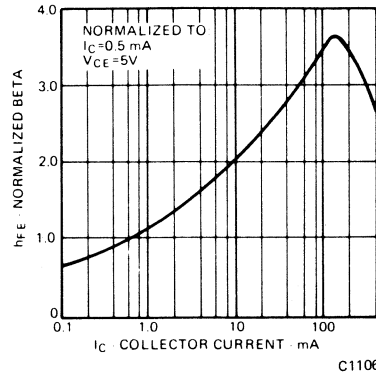


Fig. 2. Normalized Beta vs. Collector Current

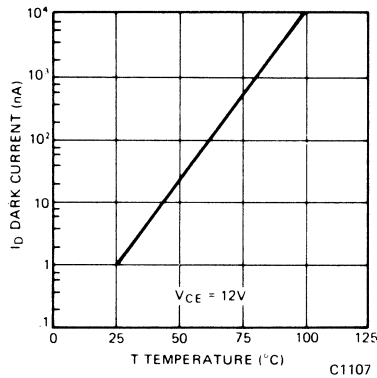


Fig. 3. Dark Current vs. Temperature

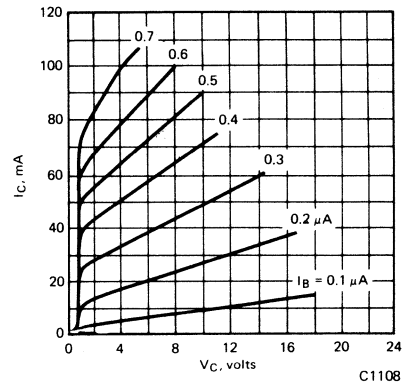


Fig. 4. Detector Standard Transfer Curves

NOTES

1. The current transfer ratio (I_C/I_F) is the ratio of the detector collector current to the LED input current with V_{CE} at 10 volts.
2. The frequency at which i_c is 3dB down from the I_{KH_z} value.
3. t_{ON} is measured from 10% of the leading edge of the input pulse to the 90% point on the leading edge of the output pulse. t_{OFF} is measured from 90% of the trailing edge of the input pulse to the 10% point on the trailing edge of the output pulse.

Monsanto

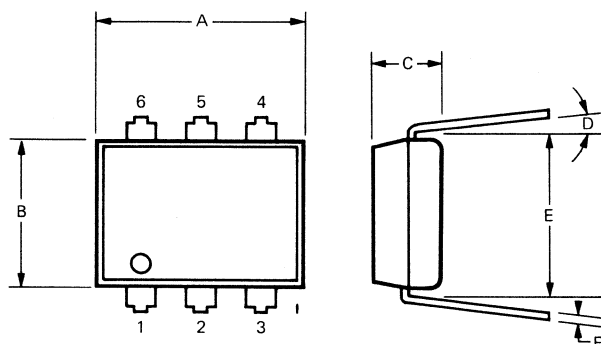
4N35 4N36 4N37

PHOTOTRANSISTOR OPTOISOLATORS

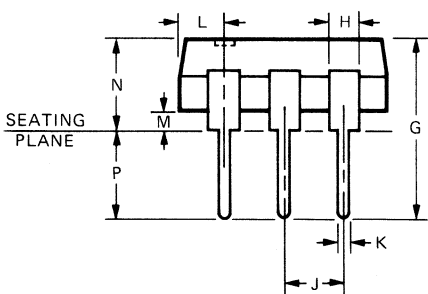
PRODUCT DESCRIPTION

The 4N35, 4N36, and 4N37 series of optoisolators have a NPN silicon planar phototransistor optically coupled to a diffused planar gallium arsenide diode. Each is mounted in a six-lead plastic DIP package.

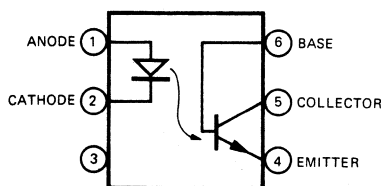
PACKAGE DIMENSIONS



C1339



PACKAGE MATERIALS:
Leads — Tinned with 60/40 tin lead
Body — Silicone plastic



FEATURES & APPLICATIONS

- AC line/digital logic isolator
- Digital logic/digital logic isolator
- Telephone/telegraph line receiver
- Twisted pair line receiver
- High frequency power supply feedback control
- Relay contact monitor
- Power supply monitor
- Industrial controls
- Covered under UL component recognition program, reference File No. E50151
- High DC current transfer ratio
- High isolation voltage

SYMBOL	INCH MAX.	MM. MAX.	NOTES
A	.365	9.27	
B	.270	6.73	
C	.130	3.18	
D	15°	15°	
E	.300 Ref	7.62 Ref	1
F	.014	0.36	
G	.325	8.26	
H	.070	1.78	
J	.110	2.79	
K	.022	0.56	
L	.085	2.16	2
M			3
N	.175	4.45	4
P			3

- NOTES
1. Installed position of lead centers
 2. Four places
 3. Overall installed position
 4. These measurements are made from the seating plane

ABSOLUTE MAXIMUM RATINGS

- *Relative humidity 85% @ 85°C
- *Storage temperature -55°C to 150°C
- *Operating temperature -55°C to 100°C
- *Lead temperature (soldering, 10 sec) 260°C

Input Diode

- *Forward DC current (continuous) 60 mA
- Reverse voltage 6 volts
- *Peak forward current
(1 μs pulse, 300 pps) 3.0 A
- *Power dissipation at T_A = 25°C 100 mW†
- *Power dissipation at T_C = 25°C 100 mW†
(T_C indicates collector lead temp
1/32" from case)

*Indicates JEDEC registered values
†Derate 1.33 mW/°C above 25°C.
††Derate 6.7 mW/°C above 25°C.

Output Transistor

- *Power dissipation at 25°C ambient 300 mW
- Derate linearly above 25°C 4 mW/°C
- *Power dissipation at T_C = 25°C 500 mW††
(T_C indicates collector lead temp
1/32" from case)

- *V_{CEO} 30 volts
- *V_{CBO} 70 volts
- *V_{ECO} 7 volts
- *Collector current (continuous) 100 mA

ELECTRO-OPTICAL CHARACTERISTICS (25°C Free Air Temperature Unless Otherwise Specified)

CHARACTERISTIC	SYMBOL	MIN.	TYP.	MAX.	UNITS	TEST CONDITIONS
Input Diode						
*Forward voltage	V_F	.8		1.50	V	$I_F = 10 \text{ mA}$
*Forward voltage temp. coefficient	V_F	.9		1.7	V	$I_F = 10 \text{ mA}, T_A = -55^\circ\text{C}$
*Forward voltage	V_F	.7		1.4	V	$I_F = 10 \text{ mA}, T_A = +100^\circ\text{C}$
*Junction capacitance	C_J			100	pF	$V_F = 0 \text{ V}, f = 1 \text{ MHz}$
*Reverse leakage current			.01	10	μA	$V_R = 6.0 \text{ V}$
Output Transistor						
DC forward current gain	h_{FE}		250			$V_{CE} = 5 \text{ V}, I_C = 100 \mu\text{A}$
*Collector to emitter breakdown voltage	BV_{CEO}	30	65		V	$I_C = 10 \text{ mA}, I_F = 0$
*Collector to base breakdown voltage	BV_{CBO}	70	165		V	$I_C = 100 \mu\text{A}$
*Emitter to collector breakdown voltage	BV_{ECO}	7	14		V	$I_C = 100 \mu\text{A}, I_F = 0$
Collector to emitter, leakage current	I_{CEO}		5	50	nA	$V_{CE} = 10 \text{ V}, I_F = 0$
*Collector to emitter leakage current (dark)	I_{CEO}			500	μA	$V_{CE} = 30 \text{ V}, I_F = 0, T_A = 100^\circ\text{C}$
Capacitance collector to emitter			8		pF	$V_{CE} = 0$
Capacitance collector to base			20		pF	$V_{CB} = 10 \text{ V}$
Capacitance base to emitter	C_{BEO}		10		pF	$V_{BE} = 0$
Coupled						
*DC current transfer ratio	CTR	100			%	$I_F = 10 \text{ mA}, V_{CE} = 10 \text{ V}$
*DC current transfer ratio	CTR	40			%	$I_F = 10 \text{ mA}, V_{CE} = 10 \text{ V}, T_A = -55^\circ\text{C}$
*DC current transfer ratio	CTR	40			%	$I_F = 10 \text{ mA}, V_{CE} = 10 \text{ V}, T_A = +100^\circ\text{C}$
*Saturation voltage—collector to emitter	$V_{CE(SAT)}$.3	volts	$I_F = 10 \text{ mA}, I_C = 0.5 \text{ mA}$
*Input to output isolation current (pulse width = 8 msec) (see Note 1)	C_{CEO} C_{CBO} I_{I-O}					
Input to output voltage = 3550 V (peak)		4N35		100	μA	
Input to output voltage = 2500 V (peak)		4N36		100	μA	
Input to output voltage = 1500 V (peak)		4N37		100	μA	
*Input to output resistance	R_{I-O}	100			gigaohms	Input to output voltage = 500 V (see Note 1)
*Input to output capacitance	C_{I-O}			2.5	picofarads	Input to output voltage = 0 V, $f = 1 \text{ MHz}$ (see Note 1)
*Turn on time— t_{on}	t_{ON}		5	10	μsec	$V_{CC} = 10 \text{ V}, I_C = 2 \text{ mA}, R_L = 100\Omega$, (see Fig. 15)
*Turn off time— t_{off}	t_{OFF}		5	10	μsec	$V_{CC} = 10 \text{ V}, I_C = 2 \text{ mA}, R_L = 100\Omega$, (see Fig. 15)

*Indicates JEDEC registered values

TYPICAL ELECTRO-OPTICAL CHARACTERISTIC CURVES
(25°C Free Air Temperature Unless Otherwise Specified)

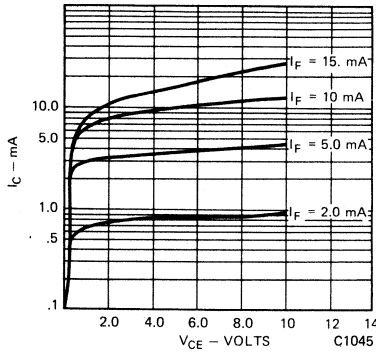


Fig. 1. Collector Current vs. Collector Voltage

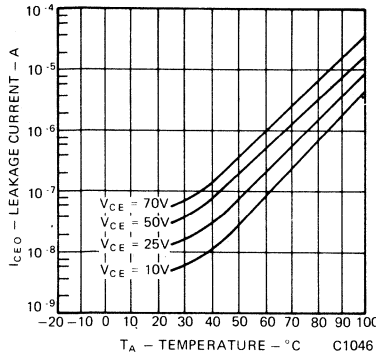


Fig. 2. Dark Current vs. Temperature

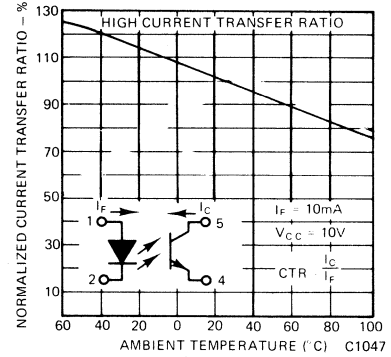


Fig. 3. Current Transfer Ratio vs. Temperature

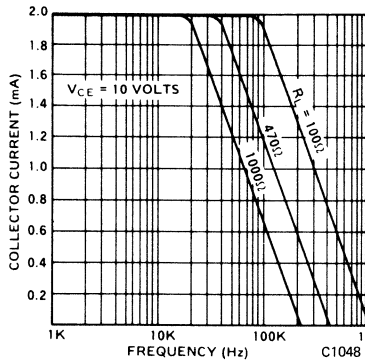


Fig. 4. Collector Current vs. Frequency

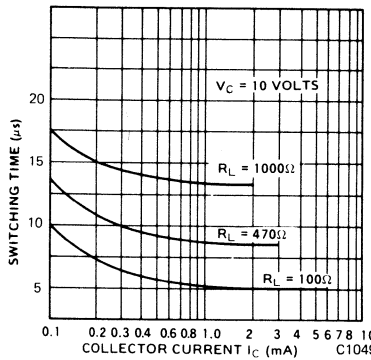


Fig. 5. Switching Time vs. Collector Current

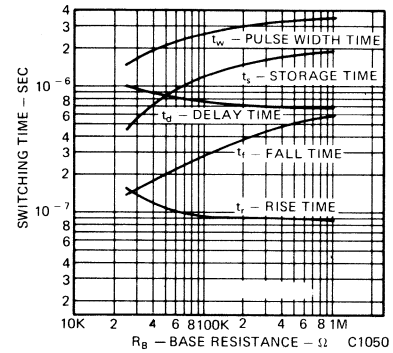


Fig. 6. Switching Time vs. Base Resistance

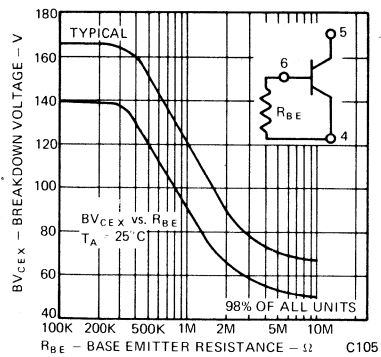


Fig. 7. Collector-Emitter Breakdown Voltage vs. Base Resistance

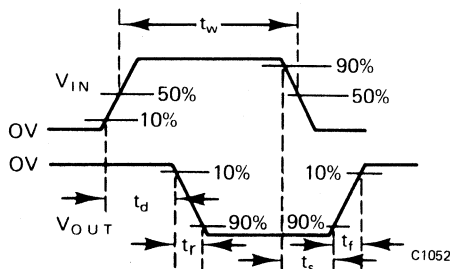


Fig. 8. Pulse Test Definition (Note 3)

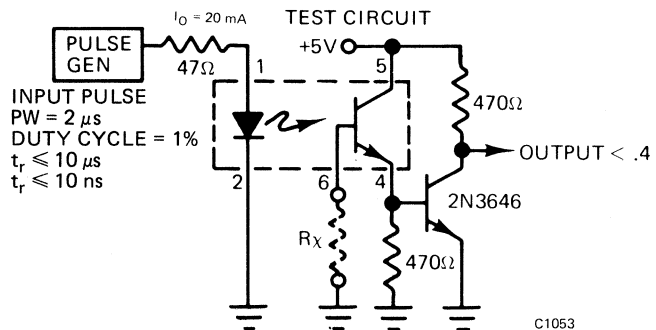


Fig. 9. Pulse Test Circuit for Fig. 7

TYPICAL ELECTRO-OPTICAL CHARACTERISTIC CURVES
(25°C Free Air Temperature Unless Otherwise Specified)

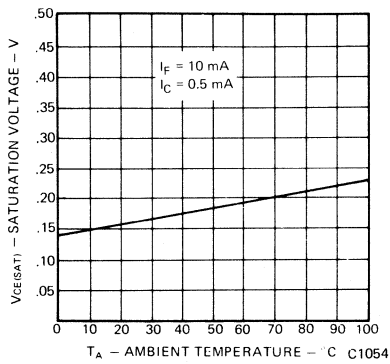


Fig. 10. Saturation Voltage vs. Temperature

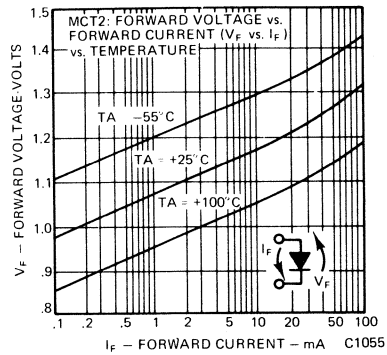


Fig. 11. Forward Voltage vs. Forward Current

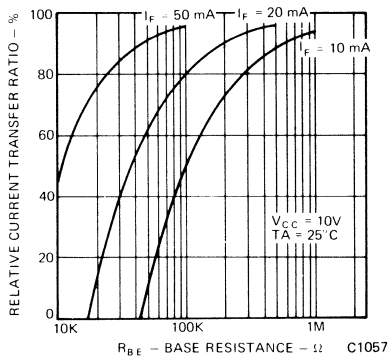


Fig. 12. Sensitivity vs. Base Resistance

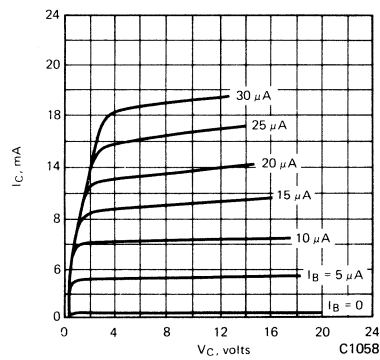


Fig. 13. Detector Standard Transfer Curves

OPERATING SCHEMATICS

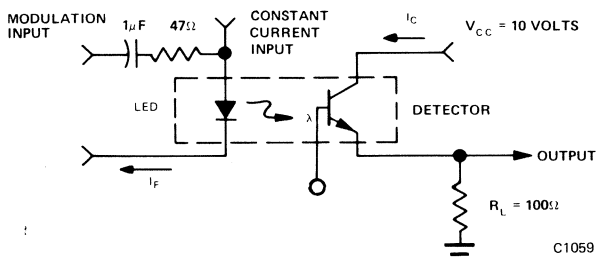


Fig. 14. Modulation Circuit Used to Obtain Output vs. Frequency Plot (Fig. 4)

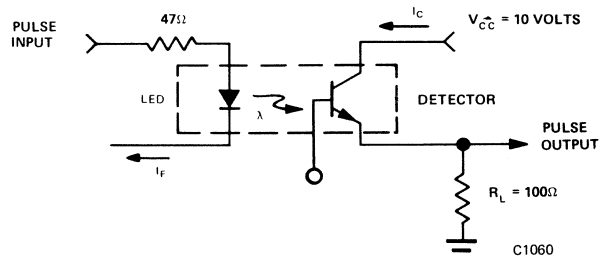


Fig. 15. Circuit Used to Obtain Switching Time vs. Collector Current Plot (Fig. 5)

NOTES

1. Tests of input to output isolation current resistance and capacitance are performed with the input terminals (diode) shorted together and the output terminals (transistor) shorted together.
2. The current transfer ratio (I_C/I_F) is the ratio of the detector collector current to the LED input current with V_{CE} at 10 volts.
3. Rise time (t_r) is the time required for the collector current to increase from 10% of its final value, to 90%. Fall time (t_f) is the time required for the collector current to decrease from 90% of its initial value to 10%.

Monsanto

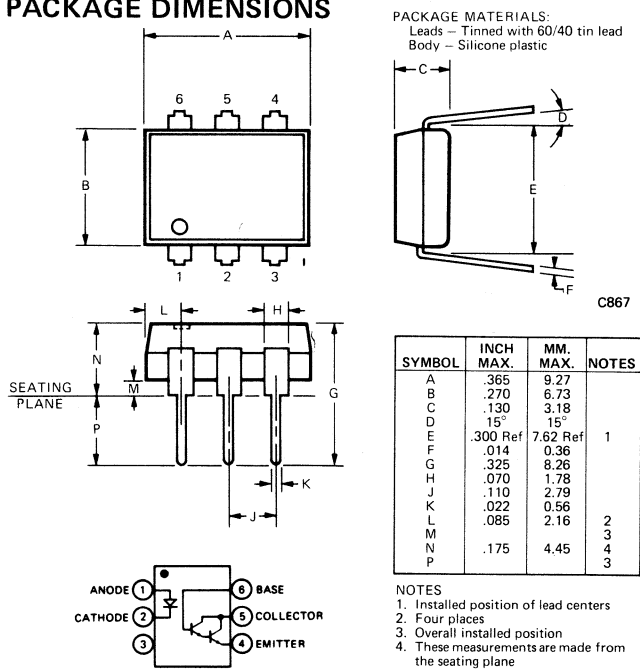
MCA230 MCA255

PHOTODARLINGTON OPTOISOLATOR

PRODUCT DESCRIPTION

The MCA230 and MCA255 optoisolators contain a gallium arsenide infrared emitting diode optically coupled to a silicon planar photo-darlington transistor. Both units are sealed in a 6-lead plastic DIP package. Electrical isolation compares favorably with that of a relay—without the relay's inherent magnetic field. The MCA230 has a minimum collector-emitter breakdown voltage of 30 volts and the MCA255, 55 volts.

PACKAGE DIMENSIONS



FEATURES & APPLICATIONS

- High collector current rating—125 mA
- Fast operate time—10 μ s
- Fast release time—35 μ s
- High isolation resistance— $10^{11} \Omega$
- High dielectric strength, input to output—3550 VDC
- Low coupling capacitance—0.5 pF
- Convenient package—plastic dual-in-line
- Long lifetime, solid state reliability
- Low weight—0.4 grams
- Replace reed relays for 50 mA, 55 V DC loads.
- Replace pulse transformers.
- Form multiple contact, NO/NC relays.
- Useful for telephone lines, telegraph lines, SCR triggers, hospital monitoring systems, airborne systems, remote data gathering systems and remote control systems.
- Use as a low-current alarm monitor for battery powered supplies.

ABSOLUTE MAXIMUM RATINGS

Storage Temperature -55°C to 150°C
 Operating Temperature -55°C to 100°C
 Lead Soldering time @ 260°C 7.0 sec
 Total power dissipation @ 25°C ambient 300 mW
 Derate linearly from 25°C 4.0 mW/ $^{\circ}\text{C}$

LED (GaAs Diode)
 Power dissipation @ 25°C ambient 90 mW
 Derate linearly from 25°C 2 mW/ $^{\circ}\text{C}$
 Continuous forward current 60 mA
 Reverse current 10 μA
 Peak forward current (1 μsec pulse, 300 pps) . . 3.0 A

DETECTOR

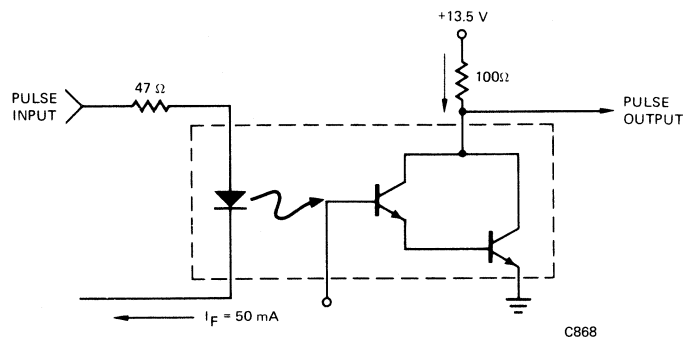
(Silicon Photo Transistor)

	MCA230	MCA255
Power dissipation		
@ 25°C ambient210 mW	.210 mW
Derate linearly from 25°C	2.8 mW/ $^{\circ}\text{C}$	2.8 mW/ $^{\circ}\text{C}$
Collector-emitter breakdown voltage (BV_{CEO})	30 V	55 V
Collector-base breakdown voltage (BV_{CBO})	30 V	55 V
Emitter-base breakdown voltage (BV_{EBO})	8.0 V	8.0 V
Collector-emitter current (I_{CE})	125.0 mA	125.0 mA

ELECTRO-OPTICAL CHARACTERISTICS (25°C Free Air Temperature Unless Otherwise Specified)

CHARACTERISTIC	SYMBOL	MIN.	TYP.	MAX.	UNITS	TEST CONDITIONS
EMITTER						
Forward Voltage	V_F		1.25	1.5	V	$I_F = 20 \text{ mA}$
Reverse Voltage	V_R	3	25		V	$I_R = 10 \mu\text{A}$
Capacitance	C_J		50		pF	$V = 0$
DETECTOR						
Gain	H_{FE}		25,000			$V_{CE} = 5 \text{ V}, I_C = 0.5 \text{ mA}$
Collector Breakdown Voltage	BV_{CEO}	30/55			V	$I_C = 100 \mu\text{A}, I_F = 0$
Base Breakdown Voltage	BV_{CBO}	30/55			V	$I_C = 10 \mu\text{A}, I_F = 0$
Emitter Breakdown Voltage	BV_{EBO}	8			V	$I_C = 1 \mu\text{A}, I_F = 0$
Collector Leakage Current	$I_{CEO} \text{ (DARK)}$		1.0	100	nA	$V_{CE} = 10 \text{ V}, I_F = 0$
Capacitance						
Collector-Emitter			3.4		pF	$V_{CE} = 10 \text{ V}$
Collector-Base			10		pF	$V_{CB} = 10 \text{ V}$
Emitter-Base			10		pF	$V_{EB} = 0.5 \text{ V}$
COUPLED						
DC Base Current Transfer Ratio			0.1		%	$I_F = 50 \text{ mA}, V_{CB} = 10 \text{ V}$
DC Collector Current Transfer Ratio		100	400		%	$I_F = 10 \text{ mA}, V_{CE} = 5 \text{ V}, \text{Note 1}$
Saturation Voltage	$V_{CE} \text{ (SAT)}$			1.0	V	$I_C = 50 \text{ mA}, I_F = 50 \text{ mA}$
Bandwidth (50% Δ CTR)			10		kHz	$I_C = 10 \text{ mA}, \text{Note 2}, R_L = 100 \Omega, V_{CE} = 10 \text{ V}$
Fall time	t_f		35		μsec	} See switching time test circuit { Note 3
Rise time	t_r		5		μsec	
ISOLATION						
DC Voltage Breakdown	V_{ISO}	3550				$V = 500 \text{ VDC}$ $V_{ISO} = 1500 \text{ VDC.}$
Resistance	R_{ISO}	10^{11}	10^{12}		Ω	
Leakage Current	I_{ISO}		10		μA	
Capacitance	C_{ISO}		0.5		pF	
Dielectric Dissipation Limit		50,000			VHz	
AC Voltage Limit @ 60 Hz		2500			V_{RMS}	

SWITCHING TIME TEST CIRCUIT



Pulse Width = 1 ms
Pulse Rep Rate = 100 Hz

TYPICAL ELECTRO-OPTICAL CHARACTERISTIC CURVES

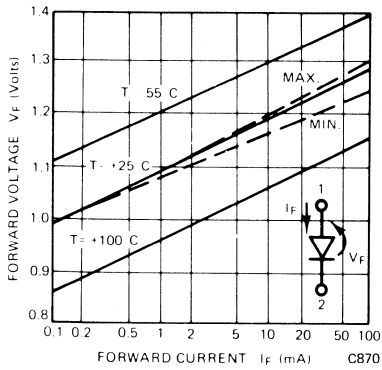


Fig. 1. Forward Voltage Drop vs. Forward Current

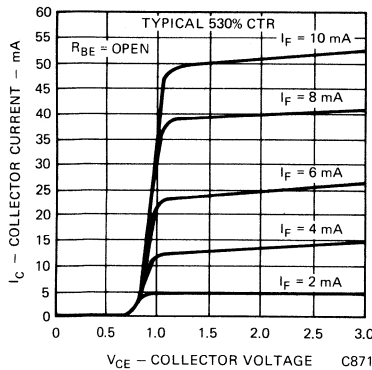


Fig. 2. Collector Current vs. Collector Voltage

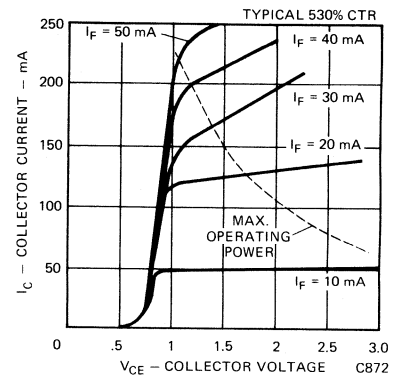


Fig. 3. Collector Current vs. Collector Voltage

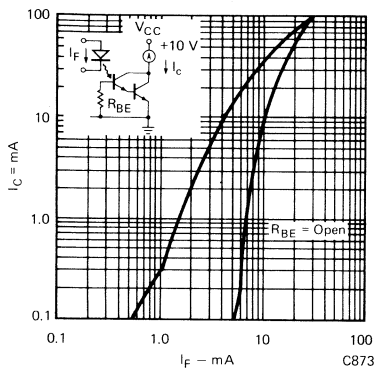


Fig. 4. Current Transfer Characteristic

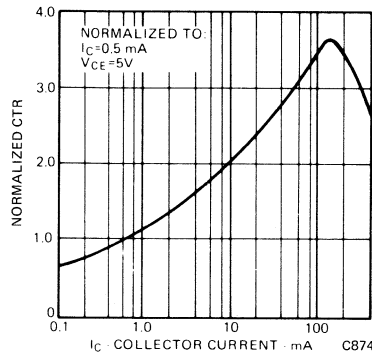


Fig. 5. Normalized CTR vs. Collector Current

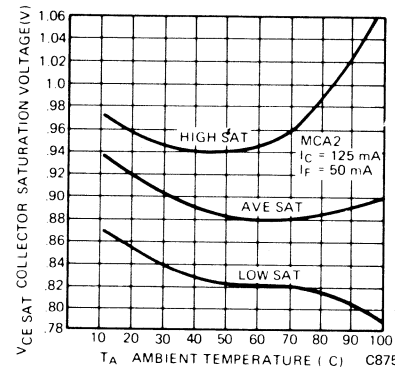


Fig. 6. V_{CE-SAT} vs. Temperature

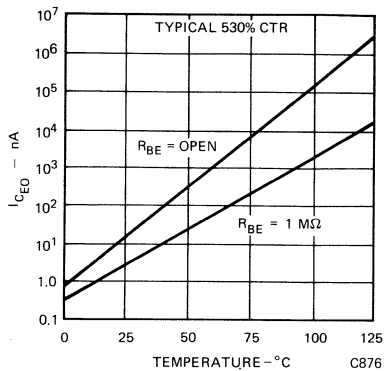


Fig. 7. I_{CEO} vs. Temperature

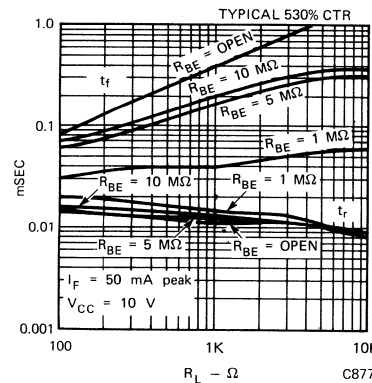


Fig. 8. Switching Times

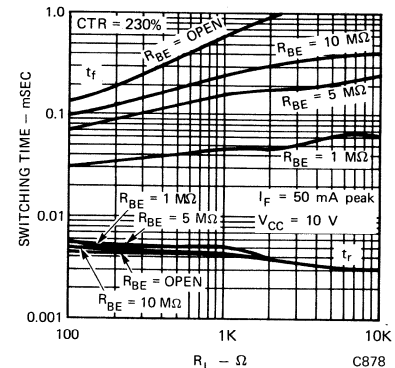


Fig. 9. Switching Times

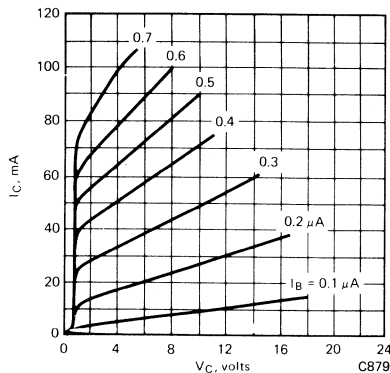


Fig. 10. Detector Standard Transfer Curves

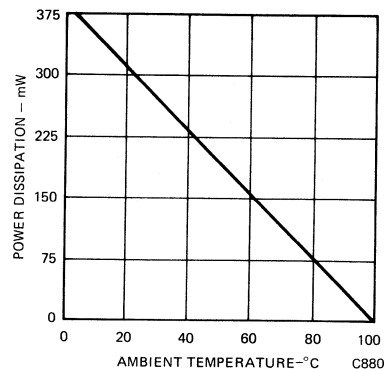


Fig. 11. Package Power Derating

DC RELAY CHARACTERISTICS (TYPICAL)

CONTACTS

Contact configuration
 Contact load rating
 Contact withstand voltage

MCA230
 MCA255

SPST-NO
 125 mA DC
 30 V DC
 55 V DC
 1.0 V
 10 μseconds
 35 μseconds

Closed contact voltage
 Operate time with 100 Ω load
 Release time with 100 Ω load

COIL

Turn on voltage
 Turn on current at rated contact load

1.3 V
 50 mA

ISOLATION

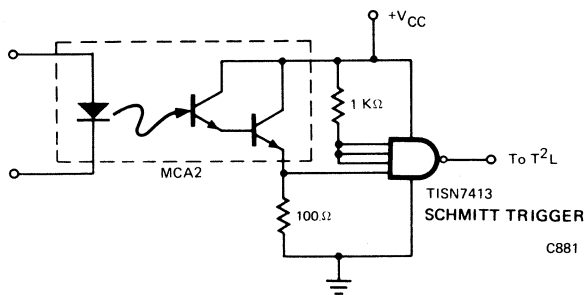
Dielectric strength, contacts to coil
 Isolation resistance, contact to coil
 Capacitance, contacts to coil

3550 VDC minimum
 10^{11} Ohms
 1.0 pF
 0.4 grams

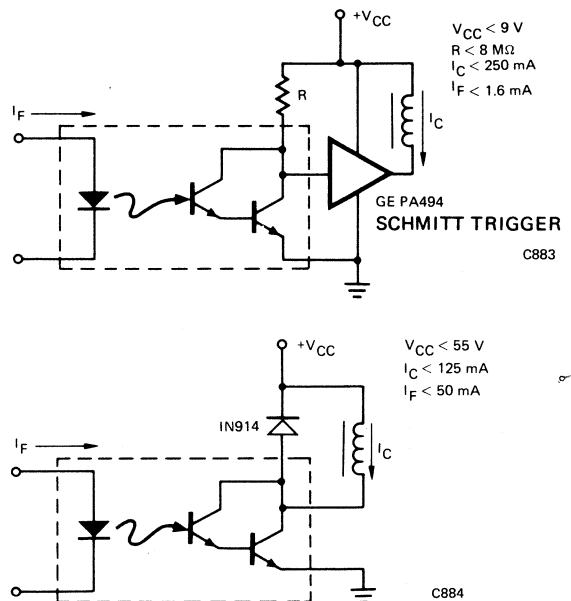
WEIGHT

APPLICATION CIRCUITS

ISOLATE T²L LOGIC WITH MCA2



OPERATING A RELAY COIL WITH MCA2



NOTES

1. The current transfer ratio (I_C/I_F) is the ratio of the detector collector current to the LED input current with V_{CE} at 5 volts.
2. The frequency at which i_C is 3 dB down from the 1 kHz value.
3. Rise time (t_r) is the time required for the collector current to increase from 10% of its final value, to 90%. Fall time (t_f) is the time required for the collector current to decrease from 90% of its initial value to 10%.

PRODUCT DESCRIPTION

The MCA231 contains a gallium arsenide infrared emitter optically coupled to a silicon planar photo-darlington. Both units are sealed in a 6-lead plastic DIP package.

PACKAGE DIMENSIONS

SYMBOL	INCH MAX.	MM. MAX.	NOTES
A	.365	9.27	
B	.270	6.73	
C	.130	3.18	
D	15°	15°	
E	.300 Ref	7.62 Ref	1
F	.014	0.36	
G	.325	8.26	
H	.070	1.78	
J	.110	2.79	
K	.022	0.56	
L	.085	2.16	2
M			3
N	.175	4.45	4
P			3

NOTES
 1. Installed position of lead centers
 2. Four places
 3. Overall installed position
 4. These measurements are made from the seating plane

PACKAGE MATERIALS:
 Leads - Tinned with 60/40 tin lead
 Body - Silicone plastic

C1339

FEATURES

- High sensitivity—1 mA on the input will sink a TTL gate.
- High isolation—3550 VDC, $10^{12} \Omega$, 0.5 pF

TYPICAL APPLICATIONS

- Isolate logic from 110/220 VAC.
- Eliminate troublesome ground loop problems by coupling directly to twisted pair lines in digital systems. Particularly useful for telephone lines, telegraph lines, SCR triggers, hospital monitoring systems, airborne systems, remote data gathering systems, and remote control systems.
- See Application Note 511—Interfacing a Darlington to TTL Logic.

ABSOLUTE MAXIMUM RATINGS

Storage Temperature Range -65°C to +150°C
Operating Temperature Range -55°C to +100°C
Lead Temp. (Soldering, 10 sec) 260°C
Total Power Diss. @ 25°C Free	
Air Temperature 275 mW
Derate Linearly to 100°C (θ_{JA}) 3.7 mW/°C
Input to Output Isolation Voltage 3550 VDC

Input Diode	
Forward DC Current 60 mA
Reverse DC Current 4 mA
Peak Forward Current (1 μ s pulse, 300 pps) 3.0 A
Output Darlington	
Collector-Emitter Voltage 30 V
Collector-Base Voltage 30 V
Emitter-Base Voltage 6 V
Collector Current 125 mA

ELECTRO-OPTICAL CHARACTERISTICS (25°C Free Air Temperature unless otherwise specified)

CHARACTERISTIC	SYMBOL	MIN.	TYP.	MAX.	UNITS	TEST CONDITIONS
Isolation between emitter and detector						
Capacitance	C_{iso}		0.5		pF	$f = 1 \text{ MHz}$
Resistance	R_{iso}	10 ¹¹	10 ¹²		Ω	$V = 500 \text{ VDC}$
Voltage Breakdown	V_{iso}	3550			VDC	$t = 1 \text{ minute}$
		850			V _{RMS}	60 Hz
Emitter (GaAs LED)						
Forward Voltage	V_F		1.15	1.5	V	$I_F = 20 \text{ mA}$
Reverse Voltage	V_R	3.0	25		V	$I_R = 10 \mu\text{A}$
Junction Capacitance	C_J		50		pF	$V_R = 0 \text{ V}$
Detector (Silicon Photo-Darlington)						
Collector Breakdown Voltage	$V(BR)_{CEO}$	30	60		V	$I_C = 1 \text{ mA}$
Base Breakdown Voltage	$V(BR)_{CBO}$	30	60		V	$I_C = 10 \mu\text{A}$
Emitter Breakdown Voltage $I_C = 50 \text{ mA}$	$V(BR)_{EBO}$	6	8		V	$I_E = 10 \mu\text{A}$
Collector Leakage Current	I_{CEO}		1	100	nA	$V_{CE} = 10 \text{ V}$
Saturation Voltage	$V_{CE(sat)}$		0.8	1.0	V	$I_C = 2 \text{ mA}, I_F = 1 \text{ mA} (CTR = 200\%)$
Saturation Voltage	$V_{CE(sat)}$		0.8	1.0	V	$I_C = 10 \text{ mA}, I_F = 5 \text{ mA} (CTR = 200\%)$
Saturation Voltage	$V_{CE(sat)}$		0.9	1.2	V	$I_C = 50 \text{ mA}, I_F = 10 \text{ mA} (CTR = 500\%)$
Base photo-current	I_B		2		μA	$V_{CB} = 5 \text{ V}, I_F = 10 \text{ mA}$
Darlington gain	h_{FE}		50 k			$I_B = 1 \mu\text{A}, V_{CE} = 1 \text{ V}$
Collector-emitter capacitance	C_{CE}		6		pF	$V_{CE} = 10 \text{ V}$
Switching Times, Coupled						
Rise time, fall time	t_r, t_f		80		μs	$V_{CC} = 10 \text{ V}, I_C = 10 \text{ mA}, R_L = 100 \Omega$
TTL gate turn-on time	t_{ON}		200		μs	$I_F = 1 \text{ mA}, \text{Fig. 10}$
TTL gate turn-off time	t_{OFF}		400		μs	$I_F = 1 \text{ mA}, \text{Fig. 10}$
DC Collector Current Transfer Ratio	CTR	200	400		%	$I_F = 10 \text{ mA}, V_{CE} = 5 \text{ V}$

TYPICAL ELECTRO-OPTICAL CHARACTERISTIC CURVES
(25°C Free Air Temperature Unless Otherwise Specified)

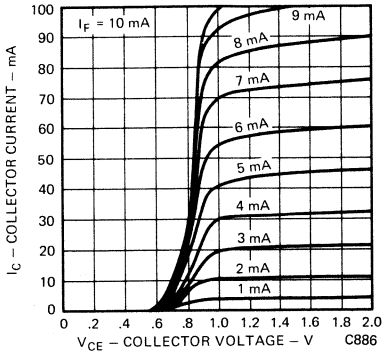


Figure 1. Collector Current vs. Collector Voltage

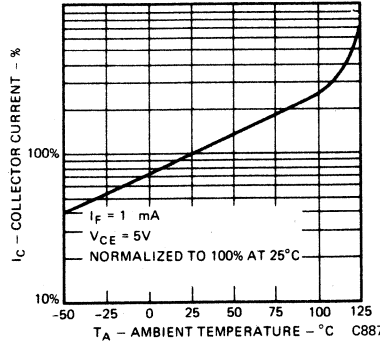


Figure 2. Collector Current vs. Ambient Temperature

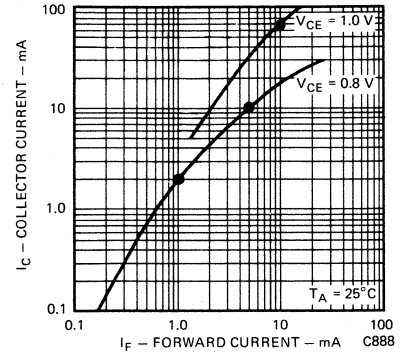


Figure 3. Collector Current vs. LED Current

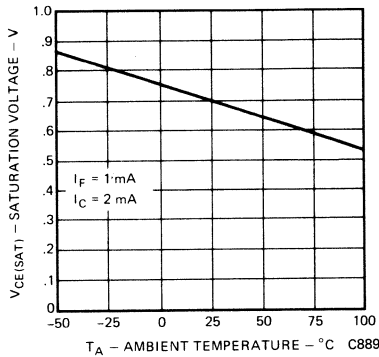


Figure 4. Saturation Voltage vs. Temperature

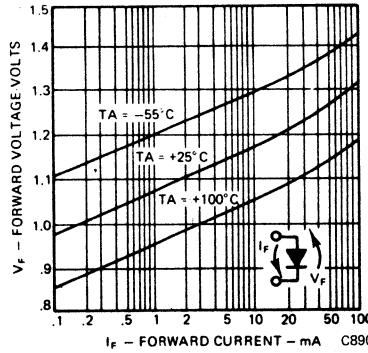


Figure 5. Forward Voltage vs. Forward Current

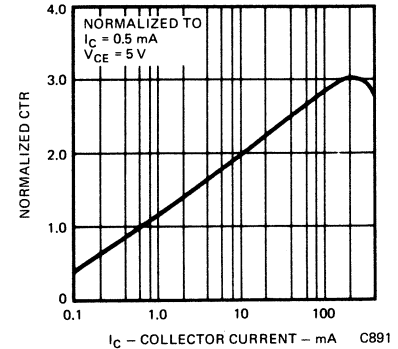


Figure 6. Normalized CTR vs. Collector Current

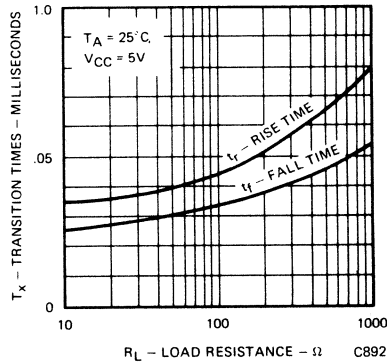


Figure 7. Non-Saturated Rise and Fall Times vs. Load Resistance

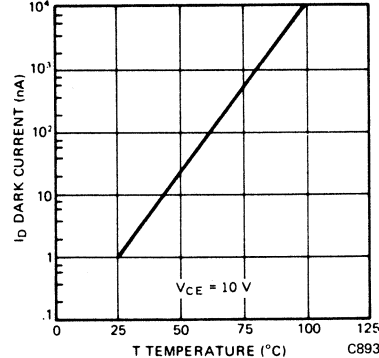


Figure 8. Dark Current vs. Temperature

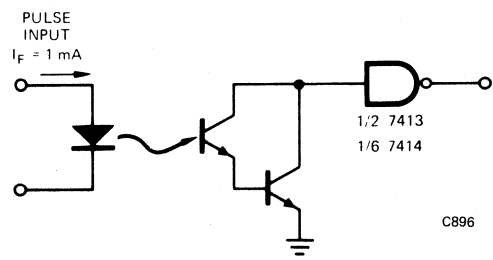
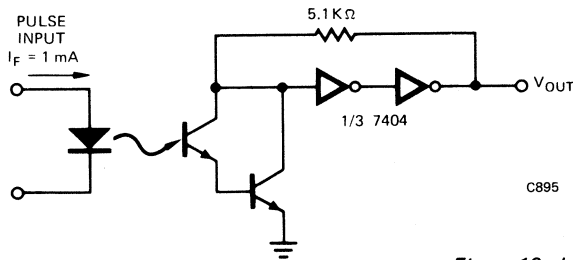


Figure 10. Logic Interface

NOTES

See MCA230 for circuits

Monsanto

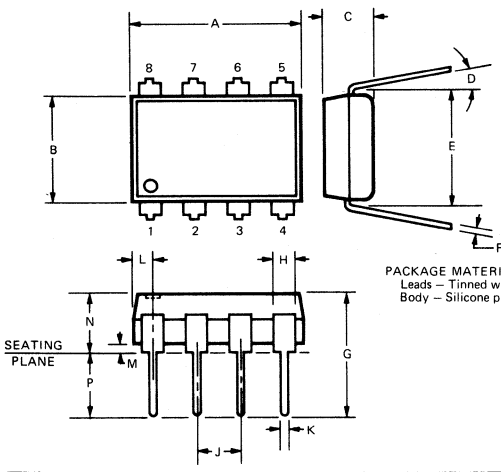
MCL600 MCL610

OPTICALLY ISOLATED LOGIC GATE

PRODUCT DESCRIPTION

The MCL600 and MCL610, are optically isolated logic gates in an 8-lead plastic DIP package. A GaAs LED radiates infrared light onto a high speed photodiode detector, thus providing electrical isolation of ± 2000 V between input and output. A differential comparator amplifies the photodiode signal, and a Schmitt trigger improves noise immunity by providing threshold and hysteresis. A standard totem pole circuit on the output offers both sourcing and sinking capability. The LED drive current requirement matches either mode of logic loading. The MCL600 has a 0.1 MHz data rate, and the MCL610 has a 1 MHz data rate.

PACKAGE DIMENSIONS



SYMBOL	INCH MAX.	MM. MAX.	NOTES
A	.410	10.29	
B	.270	6.86	
C	.130	3.30	
D	15°	15°	
E	.300 Ref	7.62 Ref	1
F	.014	0.36	
G	.325	8.26	
H	.070	1.78	
J	.110	2.79	
K	.022	0.56	
L	.055	1.40	2
M			3
N	.175	4.45	4
P			3

NOTES
 1. Installed position of lead centers
 2. Four places
 3. Overall installed position
 4. These measurements are made from the seating plane

PACKAGE MATERIALS:
 Leads - Tinned with 60/40 tin lead
 Body - Silicone plastic

PIN	FUNCTION
1	LED ANODE
2	LED CATHODE
3	N/C
4	N/C
5	OUT
6	GROUND
7	V _{CC}
8	PHOTO DIODE CATHODE

C1340

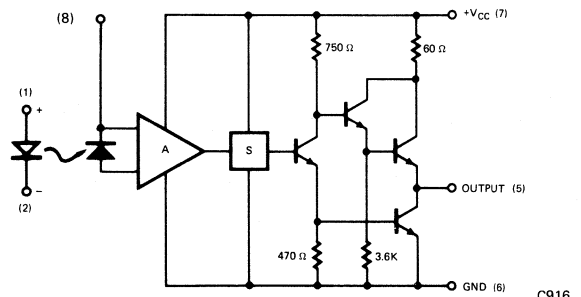
FEATURES

- Compatible TTL input drive load
- Standard TTL active totem pole output
- Single +5 volts supply required
- High toggle speed, high data rate
- Short transmission delay
- Small 8 pin DIP, two packages fit 16 pin socket
- High isolation between input-output
- High CMRR (Common Mode Rejection Ratio)
- Built-in hysteresis for noise immunity

APPLICATIONS

- Digital logic to digital logic isolator—eliminates spurious grounds
- DC input level sensor—Schmitt trigger toggle
- AC to TTL conversion—pulse shaping
- Line receiver—eliminates CMN (common mode noise) and ground loop transients
- Logic level shifter—input-output independent ground systems

SCHEMATIC DIAGRAM

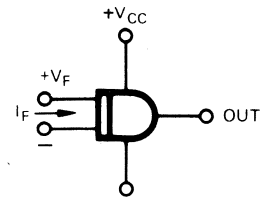


A = Differential amp, comparator
 S = Schmitt trigger, threshold hysteresis

Typical Values Shown

C916

SYMBOL



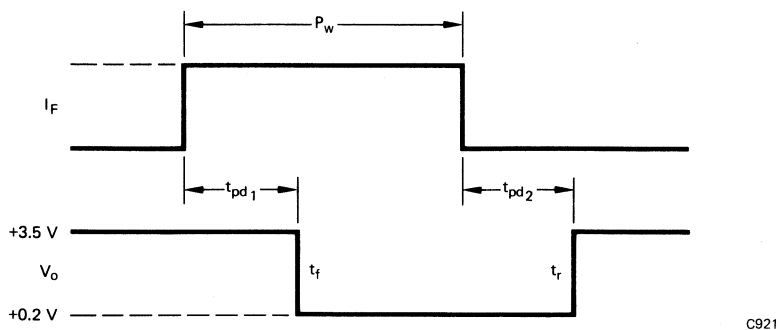
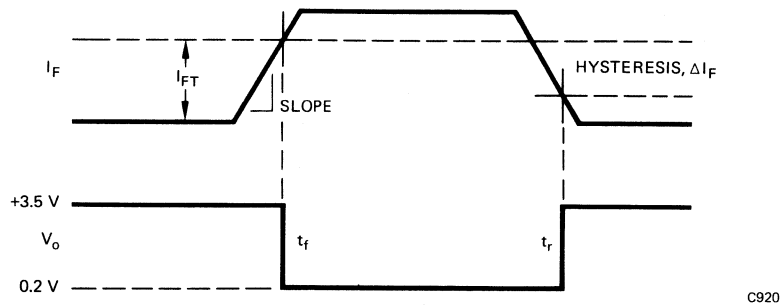
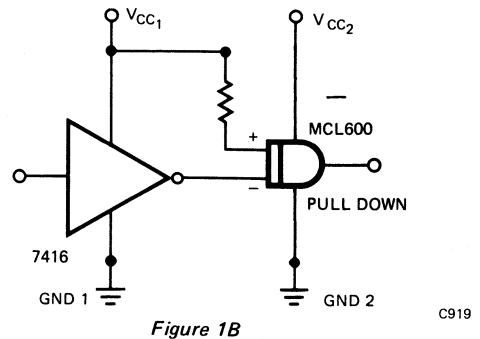
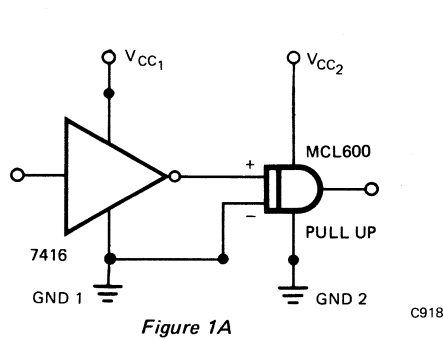
C917

ABSOLUTE MAXIMUM RATINGS

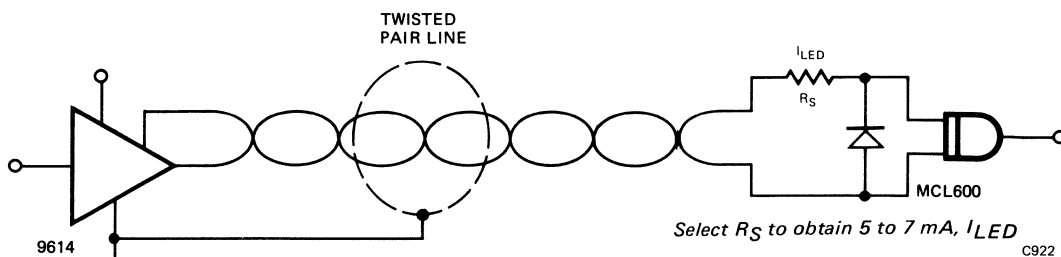
Storage temperature	-55°C to +150°C
Operating temperature	0°C to +70°C
Lead temperature (Soldering, 10 sec.)	260°C
Input Diode		
Forward DC current	20mA
Reverse Voltage	3 V
Peak forward current		
(1 μs pulse, 300 pps)	3.0 A
Power dissipation at 25°C ambient	100 mW
Derate linearly from 25°C	1.33 mW/°C
Output Gate		
Power dissipation at 25°C ambient	100 mW
Derate linearly from 25°C	1.33 mW/°C
DC supply current I _{CC}	30 mA
V _{CC}	8V
Output current low I _{OL}	16 mA
Input to output voltage	±2000 V DC

Note: The input is not specified as "HI" or "LOW" as with normal gate units. The input is "ON" or "OFF," set by the current flow through the input LED. Thus the input may be "ON" for logic drive "HI" (pull up load system, Figure 1A) or logic drive "LOW" (pull down load system, Figure 1B, as in open collector output devices.) See Z plot.

As a convenience of notation, reference will be made to a pull down type load input connected as in Figure 1B. A logical "LOW" is "ON", and a logical "HI" is "OFF".



The MCL input may be driven in series or in parallel with other MCL units, and/or in parallel with other logic units. The input of the MCL has an equivalent unit load (U.L.) rating related to current requirements.



Select R_S to obtain 5 to 7 mA, I_{LED}

RECOMMENDED OPERATING CONDITIONS

PARAMETER	LIMITS			UNITS
	MIN.	TYP.	MAX.	
Supply Voltage V_{CC}	4.5	5.0	5.5	Volts
Operating Free Air Temperature Range	0	25	70	$^{\circ}C$
Normalized Fan Out	Logic HIGH		20	U.L.
	Logic LOW		10	U.L.
Maximum Input Rise and Fall Time	Slope	{ No Restriction		
Minimum Input Rise and Fall Time		{ See Fig. 2A		
Minimum Pulse Width		t_{pd1}		

**ELECTRICAL CHARACTERISTICS OVER OPERATING TEMPERATURE RANGE (0-70 $^{\circ}C$)
(Unless Otherwise Noted)**

PARAMETER	SYMBOL	LIMITS			UNITS	TEST CONDITIONS (Note 1)
		MIN.	TYP. (Note 2)	MAX.		
Input Diode						
Forward Voltage	V_F		1.25	1.50	V	$I_F = 20\text{ mA}$
Forward Voltage Temp Coefficient			-1.8		$mV/^{\circ}C$	
Reverse Breakdown Voltage	BV_R	3.0	5.5		V	$I_R = 10\ \mu A$
Reverse Leakage Current			.001	10	μA	$V_R = 3.0\text{ V}$
Junction Capacitance	C_J		100		pF	$V_F = 0$
Rise Time	t_r		20		ns	$I_F = 50\text{ mA}, 50\Omega\text{ system}$
Fall Time	t_f		20		ns	$I_F = 50\text{ mA}, 50\Omega\text{ system}$
Output						
Output Voltage HIGH	V_{OH}	2.4	3.3		Volts	$V_{CC} = 4.5\text{ V}, I_F = 0\text{ mA}$ $I_{OH} = -0.8\text{ mA}$
Output Voltage LOW	V_{OL}		0.2	0.4	Volts	$V_{CC} = 4.5\text{ V}, I_F = (\text{ON})\text{MAX}$ $I_{OL} = 16\text{ mA}$
Supply Current with Output Short Circuit (Note 3)	I_{CCS}		25	100	mA	$V_{CC} = 5.5\text{ V}, I_F = 0\text{ mA}$
Supply Current HIGH	I_{CCH}		6	15	mA	$V_{CC} = 5.5\text{ V}, I_F = 0\text{ mA}$
Supply Current LOW	I_{CCL}		10	25	mA	$V_{CC} = 5.5\text{ V}, I_F = \text{MAX}$

MCL600, 5 mA DRIVE

Switching Characteristics (Fig. 2B)

t_{pd} (On)		1	2	μs	$I_F = 5.0\text{ mA}, I_{FT} = 3.0\text{ mA}$
t_{pd} (Off)		1	2	μs	$I_F = 5.0\text{ mA}, I_{FT} = 3.0\text{ mA}$
t_r, t_f			10	ns	$C_L = 25\text{ pF}$
Binary data rate	0.1	0.2		MHz	

Input Diode

I_F (On)		3.0	5.0	mA	
I_F (Off)	0.5	2.0		mA	
ΔI_F (hysteresis)		1.0		mA	
V_F (On)		1.15		V	$I_F = 5.0\text{ mA}$
V_F (Off)		0.95		V	$I_F = 1.0\text{ mA}$
Input load equivalent		3		U.L.	

MCL610, 15 mA DRIVE

Switching Characteristics (Fig. 2B)

t_{pd} (On) (Fig. 12)		.2	.4	μs	$I_F = 15\text{ mA}, I_{FT} = 12\text{ mA}$
t_{pd} (Off)		.2	.4	μs	$I_F = 15\text{ mA}, I_{FT} = 12\text{ mA}$
t_r, t_f			10	ns	$C_L = 25\text{ pF}$
Binary data rate	1.0	1.2		MHz	

Input Diode (Fig. 7)

I_F (On)		10	15	mA	
I_F (Off)	2.0	5		mA	
ΔI_F (hysteresis)		5		mA	
V_F (On)		1.2	1.30	V	$I_F = 15\text{ mA}$
V_F (Off)	1.00	1.1		V	$I_F = 2.5\text{ mA}$
Input load equivalent		8		U.L.	

ISOLATION

DC Voltage Breakdown	2000			VDC
AC Voltage Limit @ 60 Hz	800			VRMS
Capacitance		1.0		pF
Resistance		10^{12}		Ω

TYPICAL OPTO-ELECTRIC CHARACTERISTIC CURVES

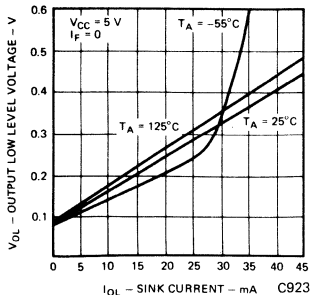


Fig. 4. Low Level Output Voltage vs. Sink Current

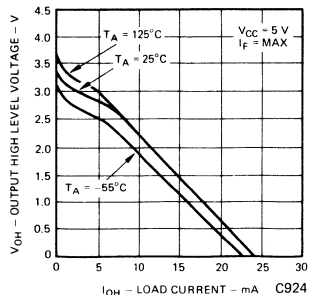


Fig. 5. High Level Output Voltage vs. Load Current

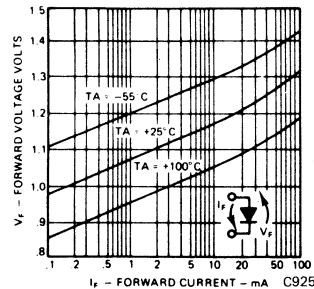


Fig. 6. Input Forward Voltage vs. Forward Current

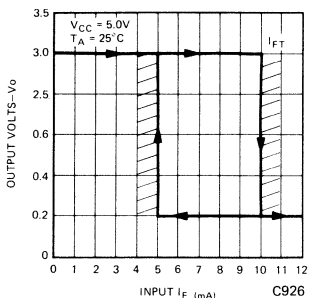


Fig. 7. MCL610—Threshold & Hysteresis of Input/Output

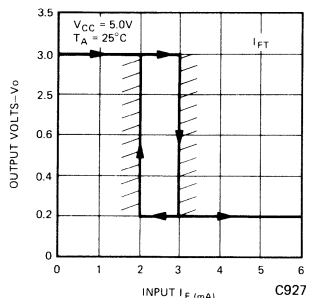


Fig. 8. MCL600—Threshold & Hysteresis of Input/Output

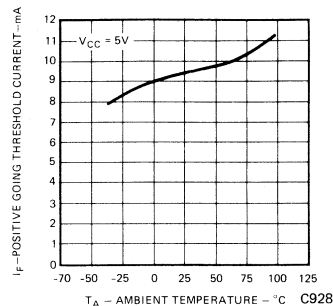


Fig. 9. MCL610—Positive-Going Threshold Current vs. Ambient Temperature

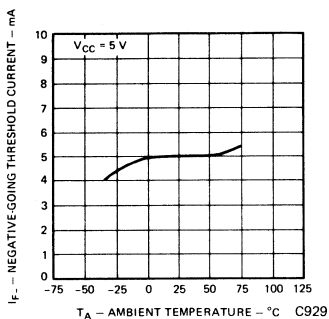


Fig. 10. MCL610—Negative-Going Threshold Current vs. Ambient Temperature

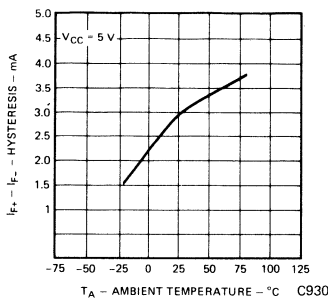


Fig. 11. MCL610—Hysteresis vs. Ambient Temperature

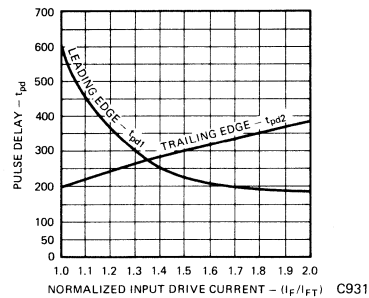


Fig. 12. MCL610—Normalized Input Drive Current vs. Pulse Delay

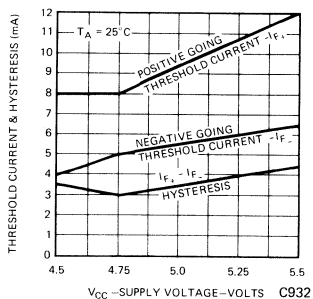


Fig. 13. MCL610—Threshold Current and Hysteresis vs. Supply Voltage

NOTES:

1. For conditions shown as MIN. or MAX., use the appropriate value specified under recommended operating conditions for the applicable device type.
2. Typical limits are at $V_{CC} = 5.0\text{ V}$, 25° C .
3. Short circuit should not exceed 1 second.

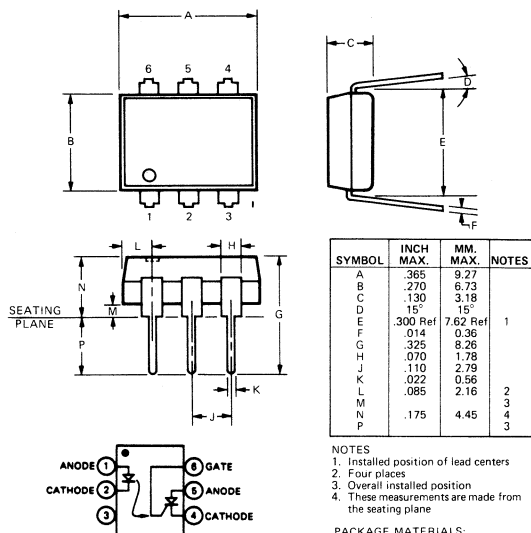
Monsanto

MCS2 MCS2400 PHOTO SCR OPTOISOLATOR

PRODUCT DESCRIPTION

The MCS2 and the MCS2400 devices consist of a photo SCR coupled to a gallium arsenide infrared diode in a six lead plastic DIP package. The MCS2 has a blocking voltage rating of 200 volts while the MCS2400 has a 400 volt rating.

PACKAGE DIMENSIONS



NOTES
 1. Installed position of lead centers
 2. Four places
 3. Overall installed position
 4. These measurements are made from the seating plane

PACKAGE MATERIALS:
 Leads - Tinned with 60/40 tin lead
 Body - Silicone plastic

C1339

FEATURES & APPLICATIONS

- Built-in memory
- AC switch (SPST)
- High current carrying capability (pulsed condition)
- Plastic dual-in-line package
- High isolation resistance— $10^{11} \Omega$
- Compact, rugged, light-weight
- Low coupling capacitance . . . 1.0 pF typical
- MCS2400, UL recognized (File #E50151)

The Photo SCR coupled pair is intended for applications where complete electrical isolation is required between low power circuitry, such as integrated circuits, and AC line voltages. It provides high speed switching of relay functions. Because of its bistable characteristics, it lends itself for use as a latching relay in direct current circuits.

ELECTRO-OPTICAL CHARACTERISTICS (25°C Free Air Unless Otherwise Specified)

CHARACTERISTICS	MCS2			MCS2400			UNITS	TEST CONDITIONS
	MIN.	TYP.	MAX.	MIN.	TYP.	MAX.		
INPUT DIODE								
Forward voltage (V_F)		1.25	1.5		1.25	1.5	V	$I_F = 20\text{mA}$
Reverse voltage (V_R)	3.0	—	—	3.0	—	—	V	$I_R = 10 \mu\text{A}$
Reverse current (I_R)	—	.001	10	—	.001	10	μA	$V_R = 3.0 \text{V}$
Junction capacitance (C_J)	—	50	—	—	50	—	pF	$V = 0$
DETECTOR								
Forward leakage current (I_{FX})	—	.02	2.0	—	.02	2.0	μA	$V_{FX} = \text{Rated } V_{FX}, R_{GK} = 27\text{k}\Omega$
Reverse leakage current (I_{RX})	—	.02	2.0	—	.02	2.0	μA	$V_{RX} = \text{Rated } V_{RX}, R_{GK} = 27\text{k}\Omega$
Forward blocking voltage (V_{FXM}, V_{DMM})	200	—	—	400	—	—	V	$R_{GK} = 10\text{k}\Omega @ 100^\circ\text{C}$
Reverse blocking voltage (V_{ROM})	200	—	—	400	—	—	V	$R_{GK} = 10\text{k}\Omega @ 100^\circ\text{C}$
On voltage (V_{TM})	—	.98	1.3	—	.98	1.3	V	$I_T = 100 \text{mA}$
Holding current (I_{HX})	.01	.16	.50	.01	.16	.50	mA	$R_{GK} = 27\text{k}\Omega$
Gate trigger voltage (V_{GT})	—	0.5	1.0	—	0.6	1.0	V	$V_{FX} = 100 \text{V}$
Gate trigger current (I_{GT})	—	19	100	—	23	100	μA	$V_{FX} = 100 \text{V}, R_L = 10\text{k}\Omega, R_{GK} = 27\text{k}\Omega$
COUPLED								
Turn on current (threshold), (I_{FT})	0.5	5.0	14	0.5	5.0	14	mA	$V_{FX} = 100 \text{V}, R_{GK} = 27\text{k}\Omega$
$t_r + t_d$ (See note 1) = (t_{on})	—	7	—	—	7	—	μs	$I_F = 30 \text{mA}, R_{GK} = 27\text{k}\Omega, V_{CC} = 20 \text{V}$
Steady state voltage (V_{ISO})	1750	—	—	3150	—	—	VDC	$t = 1 \text{min.}$
Surge isolation rating	1250	—	—	2250	—	—	V_{RMS}	$t = 1 \text{min.}$
	2500	—	—	3550	—	—	VDC	$t = 1 \text{sec.}$
Isolation resistance (R_{ISO})	1500	—	—	2550	—	—	V_{RMS}	$t = 1 \text{sec.}$
	10 ¹¹	10 ¹²	—	10 ¹¹	10 ¹²	—	Ω	$V = 500 \text{VDC}$
Isolation capacitance (C_{ISO})	—	1.0	2	—	1.0	2	pF	$f = 1 \text{MHz}$
Dielectric dissipation limit (D)	—	50,000	—	—	50,000	—	V-Hz	$t = 15 \text{minutes}$
AC voltage limit	—	800	—	—	800	—	V_{RMS}	$f = 60 \text{Hz}$

ABSOLUTE MAXIMUM RATINGS

Storage temperature -55°C to 150°C
 Operating temperature -55°C to 100°C
 Lead soldering time @ 260°C 7.0 seconds

LED (GaAs Diode)

Power dissipation @ 25°C ambient 60 mW
 Derate linearly from 25°C $0.8\text{ mW}/^{\circ}\text{C}$
 Continuous forward current 40 mA
 Reverse current $10\ \mu\text{A}$
 Peak forward current 0.5 A
 (50 μs pulse, 120 pps)

COUPLED

Isolation voltage 3550 VDC
 Total package power dissipation 250 mW

DETECTOR (Photo SCR)

Power dissipation @ 25°C ambient 200 mW
 Derate linearly from 25°C $2.67\text{ mW}/^{\circ}\text{C}$
 MCS2 DC anode current 150 mA
 MCS2400 DC anode current 100 mA
 Peak pulse current (100 μs , 120 pps) 1.0 A
 Average gate current 25 mA
 Reverse gate current 1.0 mA
 MCS2 anode voltage (DC or peak AC) 200 V
 MCS2400 anode voltage (DC or peak AC) 400 V

ELECTRO-OPTICAL CHARACTERISTIC CURVES (25°C Free Air Unless Otherwise Specified)

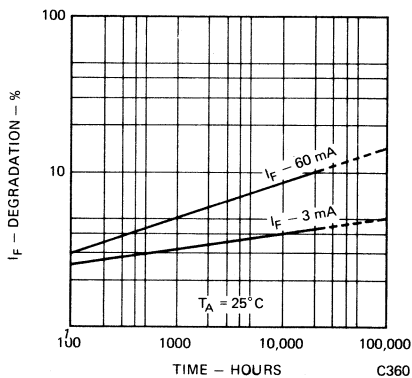


Fig. 1. LED Lifetime vs. Forward Current

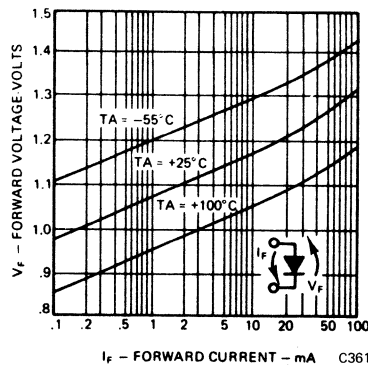


Fig. 2. Forward Voltage vs. Forward Current

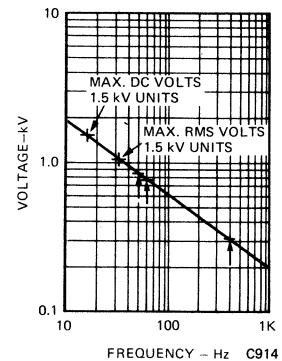


Fig. 3. Steady-State AC Voltage Limit of Isolation Dielectric vs. Line Frequency

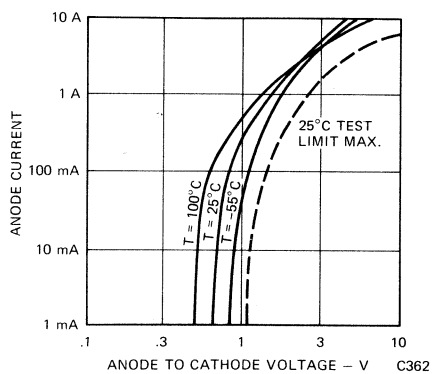


Fig. 4. Anode Current vs. Anode-Cathode Voltage

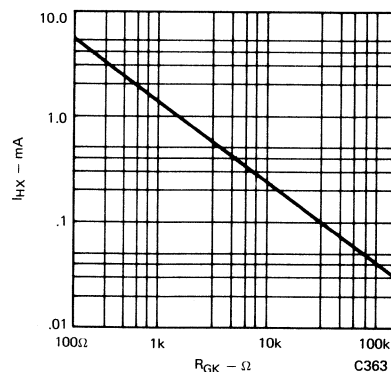


Fig. 5. Holding Current vs. Gate-Cathode Resistance

ELECTRO-OPTICAL CHARACTERISTIC CURVES (Cont'd) (25°C Free Air Unless Otherwise Specified)

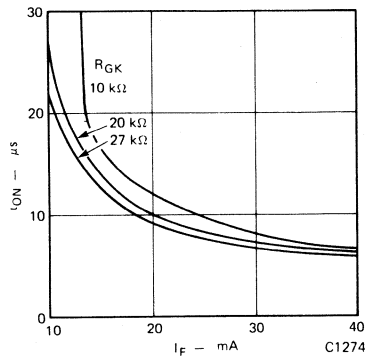


Fig. 6. Trigger Delay Time vs. Forward Current (note 1)

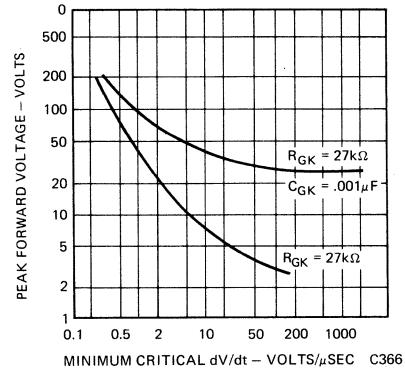


Fig. 7. Forward Blocking Voltage vs. Critical dV/dt

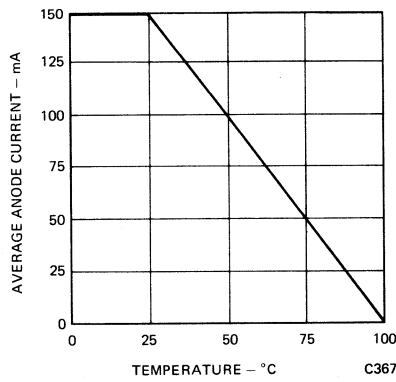


Fig. 8. Continuous Current Rating vs. Ambient Temperature

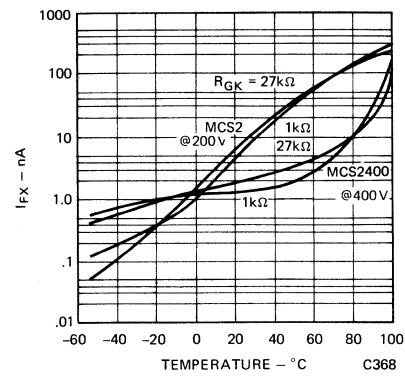


Fig. 9. Forward Leakage Current vs. Temperature

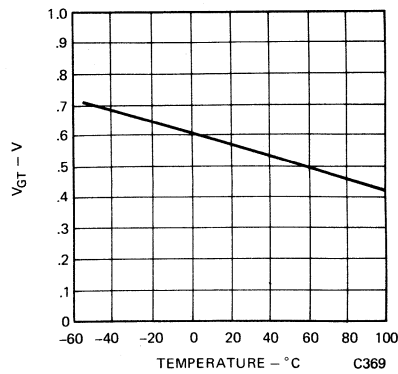


Fig. 10. Gate Trigger Voltage vs. Temperature

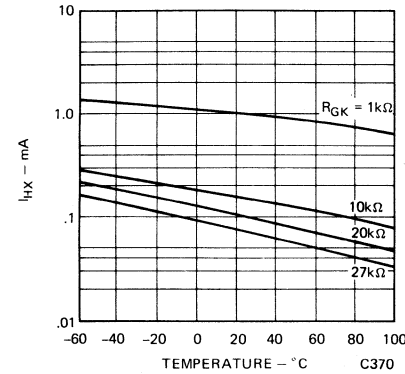
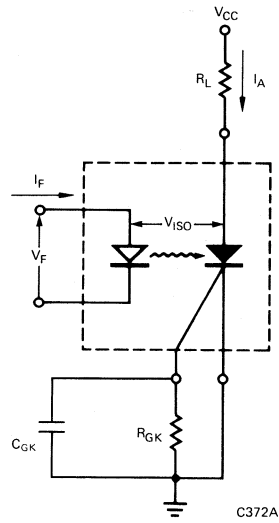
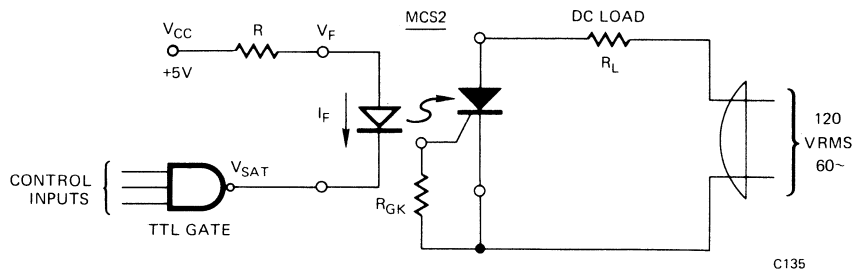


Fig. 11. Holding Current vs. Temperature

TYPICAL CIRCUIT APPLICATIONS



OPERATING SCHEMATICS



RELAY CIRCUIT FOR HALF WAVE A.C. CONDUCTION

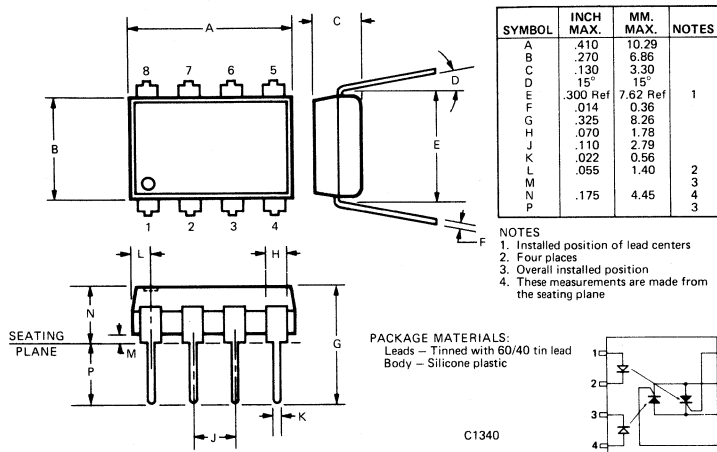
NOTES

1. The rise time of the SCR is typically less than 500 nanoseconds.

PRODUCT DESCRIPTION

The MCS6200 series are optically-isolated solid state relays with two photo-SCR's connected Anode-to-Cathode (see circuit diagram). Two Light Emitting Diodes, coupled to the photo-SCR's, provide independent SCR control. The MCS6200 features an input to output minimum breakdown voltage of 1500 VDC, while the MCS6201 features 2500 VDC.

PACKAGE DIMENSIONS



FEATURES

- Fast switching
- Independent direction control
- Low input control power
- High pulse current capability
- High voltage isolation between input and output
- Compact plastic DIP package

APPLICATIONS

- AC power control
- Triac triggering
- Bi-directional motor control
- DC power supply polarity control

ABSOLUTE MAXIMUM RATINGS Storage temperature -55°C to 150°C
 Operating temperature -55°C to 100°C
 Lead soldering time @ 260°C 7.0 seconds

LED (GaAs Diode)
 Power dissipation @ 25°C ambient 60 mW
 Derate linearly from 25°C $0.8\text{ mW}/^{\circ}\text{C}$
 Continuous forward current 40 mA
 Reverse voltage 3.0 volts
 Peak forward current 0.5 A
 (50 μs pulse, non-repetitive)

DETECTOR (Photo SCR) each direction
 Power dissipation @ 25°C ambient 200 mW
 Derate linearly from 25°C $2.67\text{ mW}/^{\circ}\text{C}$
 Continuous forward current 150 mA
 Peak pulse current (100 μsec @ 120 pps) 0.5 A
 Average gate current 25 mA
 Reverse gate current 1.0 mA

COUPLED
 Total package power dissipation
 at 25° 400 mW
 Derate linearly from 25°C $5.3\text{ mW}/^{\circ}\text{C}$
 Input to output breakdown voltage
 MCS6200 1500 VDC
 MCS6201 2500 VDC

ELECTRO-OPTICAL CHARACTERISTICS (25°C Free Air Temperature Unless Otherwise Specified)

CHARACTERISTIC	SYMBOL	MIN.	TYP.	MAX.	UNITS	TEST CONDITIONS
LED (each)						
Forward voltage	V_F		1.25	1.5	V	$I_F = 20\text{ mA}$
Reverse voltage	V_R	3.0	—	—	V	$I_R = 10\ \mu\text{A}$
Reverse current	I_R	—	.001	10	μA	$V_R = 3.0\text{ V}$
Junction capacitance	C_J	—	50	—	pF	$V_F = 0\text{ V}$

ELECTRO-OPTICAL CHARACTERISTICS (Con't)

CHARACTERISTIC	SYMBOL	MIN.	TYP.	MAX.	UNITS	TEST CONDITIONS
DETECTOR (each)						
Forward leakage current	I_{FX}	—	.02	2.0	μA	$V_{FX} = \text{Rated } F_{FXM}, R_{GK} = 27 \Omega$
Reverse leakage current	I_{RX}	—	.02	2.0	μA	$V_{RX} = \text{Rated } V_{RDM}, R_{GK} = 27 \Omega$
Max. forward and reverse blocking voltage (Note 1)	V_{FXM}, V_{ROM}	200	—	—	V	$R_{GK} = 27 k\Omega$
On voltage	V_{TM}	—	1.0	1.3	V	$I_T = 100 \text{ mA}$
Holding current	I_{HX}	.01	.15	2.0	mA	$R_{GK} = 27 k\Omega$
Gate trigger voltage	V_{GT}	—	.5	1.0	V	$V_{FX} = 100 \text{ V}$
Gate trigger current (direct drive)	I_{GT}	—	15	100	μA	$V_{FX} = 100 \text{ V}, R_L = 10 k\Omega, R_{GK} = 27 k\Omega$
	I_{GT}	—	45	500	μA	$V_{FX} = 100 \text{ V}, R_L = 10 k\Omega, R_{GK} = 10 k\Omega$
	I_{GT}	—	0.5	2.0	mA	$V_{FX} = 100 \text{ V}, R_L = 10 k\Omega, R_{GK} = 1 k\Omega$
COUPLED						
Turn on current	I_F	2	8	14	mA	$V_{FX} = 100 \text{ V}, R_{GK} = 27 k\Omega$
Trigger time	$t_{on} = t_r + t_d$	—	7.0	—	μsec	$R_{GK} = 27 k\Omega, I_F = 30 \text{ mA}, V_{CC} = 20 \text{ V}$
AC turn on current (Note 2)	I_F	20	—	—	mA	$V_{CC} = 120 \text{ VAC}, I_T = 100 \text{ mA}, R_{GK} = 27 k\Omega$
ISOLATION						
Isolation breakdown voltage	V_{ISO}					$t = 1 \text{ minute}$
MCS6200		1500	—	—	VDC	
MCS6201		2500	—	—	VDC	
Isolation resistance	R_{ISO}	—	10^{11}	—	Ω	$V = \text{Rated } V_{ISO}$
Capacitance	C_{ISO}	—	1.0	—	pf	$f = 1 \text{ MHz}$
Dielectric dissipation limit			50,000		V-Hz	15 minutes
AC voltage limit @ 60 Hz			800		V_{RMS}	15 minutes

Note 1. Due to the asymmetry of the devices, the reverse avalanche breakdown of one channel may not be protected by the forward breakdown of the other channel, when a 200 volt level is exceeded.

Note 2. To ensure conduction in both directions, see "TRIAC CONNECTION" schematic.

TYPICAL ELECTRO-OPTICAL CHARACTERISTIC CURVES
(25°C Free Air Temperature Unless Otherwise Specified)

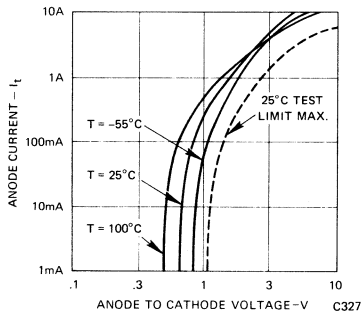


Fig. 1. I_T vs. V_{TM}

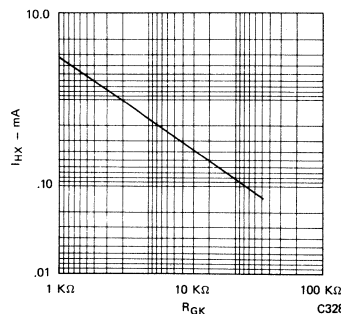


Fig. 2. Holding Current (I_{HX} vs. R_{GK})

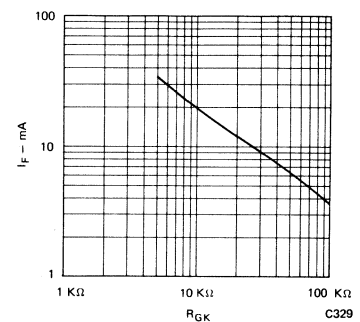


Fig. 3. Turn On vs. R_{GK}

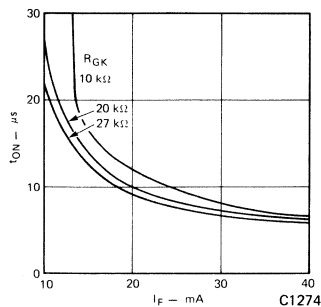


Fig. 4. Trigger Delay Time vs. Forward Current (note 1)

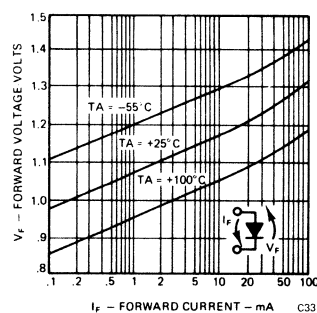


Fig. 5. Forward Voltage vs. Forward Current

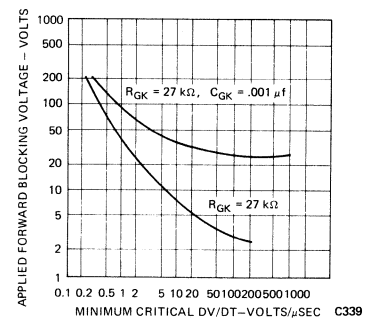


Fig. 6. dV/dt @ 25°C

TYPICAL ELECTRO-OPTICAL CHARACTERISTIC CURVES (Con't)

(25°C Free Air Temperature Unless Otherwise Specified)

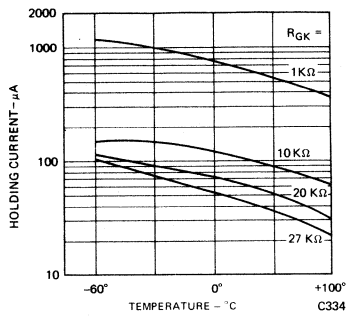


Fig. 7. I_{HX} vs. Temp. °C

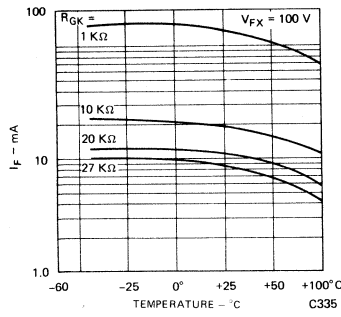


Fig. 8. I_F vs. Temp.

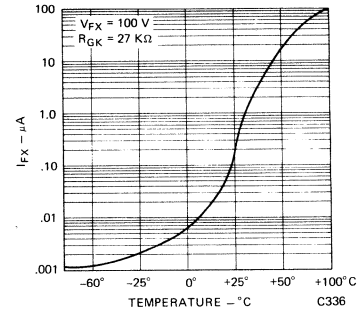


Fig. 9. I_{FX} vs. Temp.

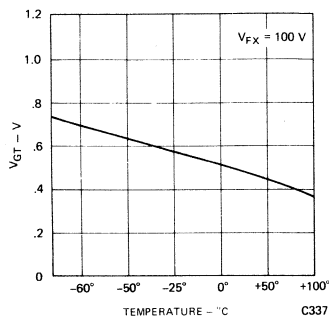


Fig. 10. Gate Trigger Voltage V_{GT} vs. T

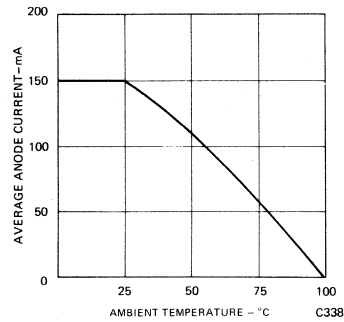
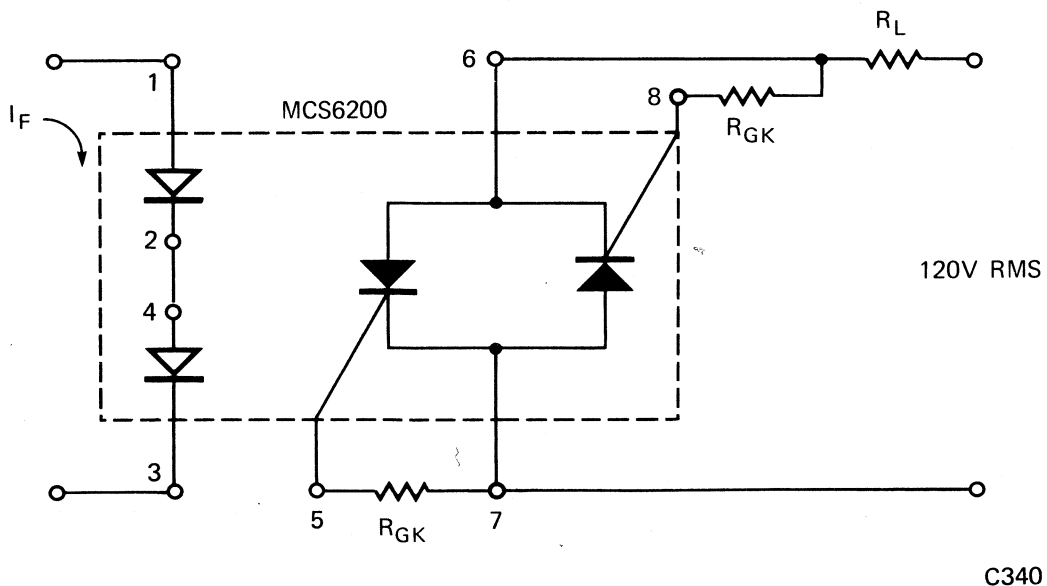


Fig. 11. Anode Current Derating

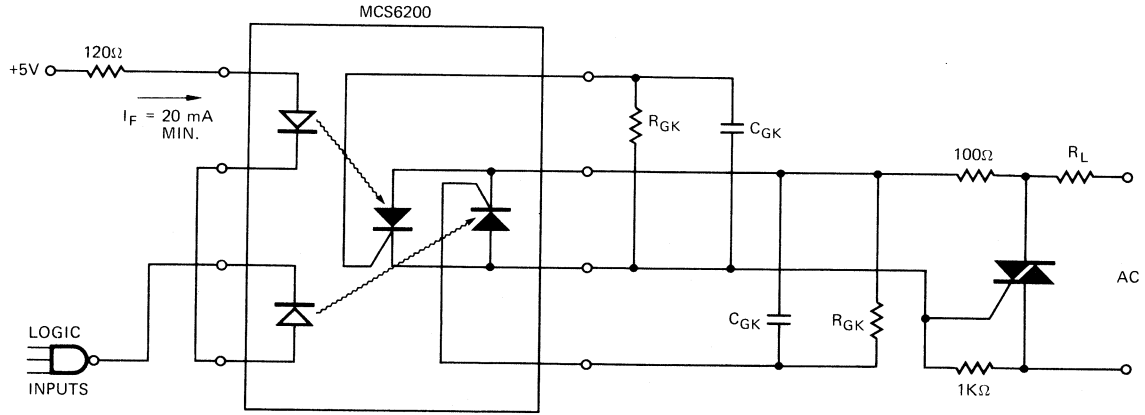
TYPICAL CIRCUIT APPLICATIONS



C340

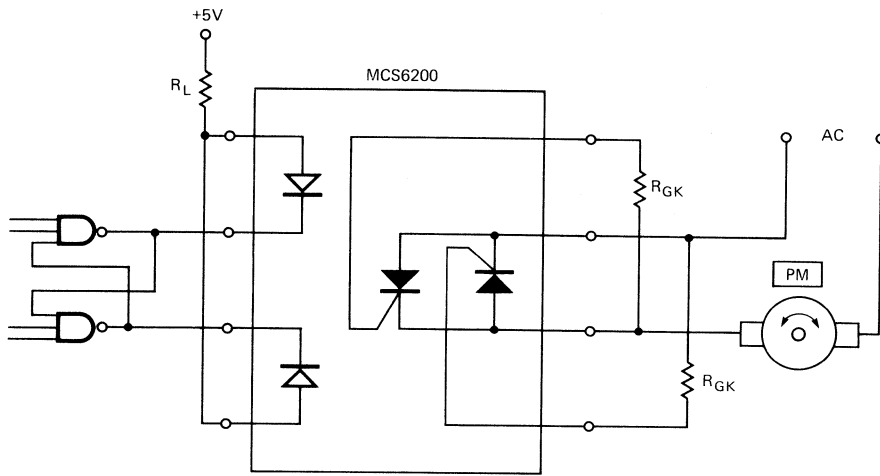
A. TRIAC CONNECTION

TYPICAL CIRCUIT APPLICATIONS (Cont'd)



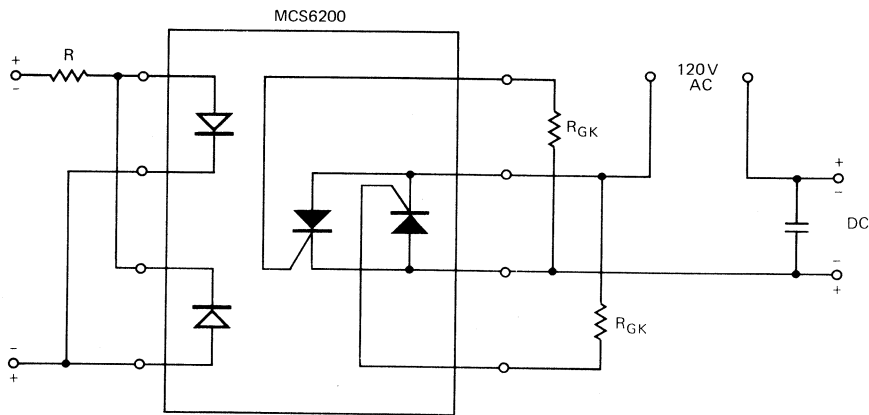
C341

B. TRIAC TRIGGER



C342

C. BI-DIRECTIONAL MOTOR CONTROL



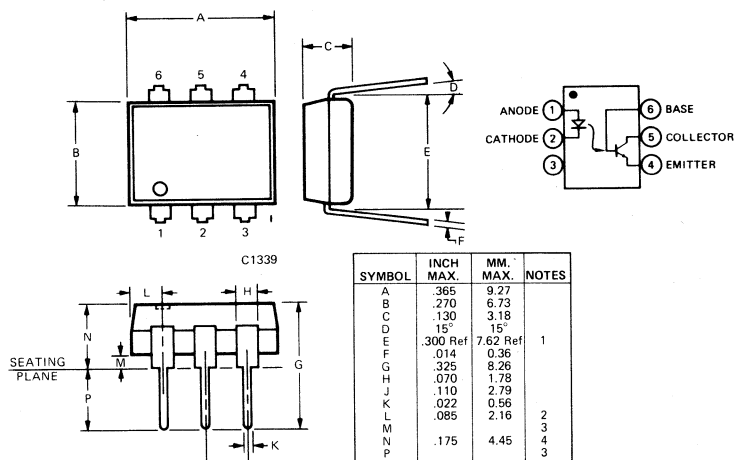
C343

D. DC POWER SUPPLY POLARITY CONTROL

PRODUCT DESCRIPTION

The MCT2 is a NPN silicon planar phototransistor optically coupled to a gallium arsenide diode. It is mounted in a six-lead plastic DIP package.

PACKAGE DIMENSIONS



PACKAGE MATERIALS:
Leads - Tinned with 60/40 tin lead
Body - Silicone plastic

- NOTES
1. Installed position of lead centers
2. Four places
3. Overall installed position
4. These measurements are made from the seating plane

APPLICATIONS

- AC line/digital logic isolator
- Digital logic/digital logic isolator
- Telephone/telegraph line receiver
- Twisted pair line receiver
- High frequency power supply feedback control
- Relay contact monitor
- Power supply monitor

ABSOLUTE MAXIMUM RATINGS

Storage temperature -55°C to 150°C
Operating temperature -55°C to 100°C
Lead temperature (Soldering, 10 sec) 260°C

Input Diode

Forward DC current 60 mA
Reverse current $10\ \mu\text{A}$
Peak forward current
(1 μs pulse, 300 pps) 3.0 A
Power dissipation at 25°C ambient 200 mW
Derate linearly from 25°C $2.6\ \text{mW}/^{\circ}\text{C}$

Output Transistor

Power dissipation at 25°C ambient 200 mW
Derate linearly from 25°C $2.6\ \text{mW}/^{\circ}\text{C}$
Input to output voltage isolation MCT2 1500 volts DC
Input to output voltage isolation MCT2E 2500 volts DC
Total package power dissipation at
 25°C ambient (LED plus detector) 250 mW
Derate linearly from 25°C $3.3\ \text{mW}/^{\circ}\text{C}$
Collector-Emitter Current (I_{CE}) 50 mA

ELECTRO-OPTICAL CHARACTERISTICS (25°C Free Air Temperature Unless Otherwise Specified)

CHARACTERISTIC	SYMBOL	GUAR. MIN.	TYP.	GUAR. MAX.	UNITS	TEST CONDITIONS
Input Diode						
Forward Voltage	V_F		1.25	1.50	V	$I_F = 20\ \text{mA}$
Reverse Breakdown Voltage	BV_R	3.0	25		V	$I_R = 10\ \mu\text{A}$
Junction Capacitance	C_J		50		pF	$V_F = 0\ \text{V}$
Reverse Leakage Current	I_R		.01	10	μA	$V_R = 3.0\ \text{V}$
Output Transistor						
DC Forward Current Gain	h_{FE}		250			$V_{CE} = 5\ \text{V}, I_C = 100\ \mu\text{A}$
Collector To Emitter Breakdown Volt.	BV_{CEO}	30	85		V	$I_C = 1.0\ \text{mA}, I_F = 0$
Collector To Base Breakdown Voltage	BV_{CBO}	70	165		V	$I_C = 10\ \mu\text{A}$
Emitter to Collector Breakdown Voltage	BV_{ECO}	7	14		V	$I_C = 100\ \mu\text{A}, I_F = 0$
Collector To Emitter, Leakage Current	I_{CEO}		5	50	nA	$V_{CE} = 10\ \text{V}, I_F = 0$, Note 5
Collector To Base Leakage Current	I_{CBO}		0.1	20	nA	$V_{CB} = 10\ \text{V}, I_F = 0$

ELECTRO-OPTICAL CHARACTERISTICS (25°C Free Air Temperature Unless Otherwise Specified)

CHARACTERISTIC	SYMBOL	GUAR. MIN.	TYP.	GUAR. MAX.	UNITS	TEST CONDITIONS
Capacitance Collector To Emitter	C_{CEO}		8		pF	$V_{CE}=0$
Capacitance Collector To Base	C_{CBO}		20		pF	$V_{CB}=10\text{ V}$
Capacitance Emitter To Base	C_{EBO}		10		pF	$V_{BE}=0$
Coupled DC Collector Current Transfer Ratio	I_C/I_F	20	60		%	$V_{CE}=10\text{ V}$, $I_F=10\text{ mA}$, Note 1
DC Base Current Transfer Ratio	I_B/I_F		.35		%	$V_{CB}=10\text{ V}$, $I_F=10\text{ mA}$
Isolation Voltage MCT2		1500	2300		VDC	
Isolation Resistance		800			VRMS	$f=60\text{ Hz}$
Isolation Capacitance		10^{11}	10^{12}		Ω	$V_{I-O}=500\text{ V}$
Collector-Emitter, Saturation Voltage	$V_{CE(sat)}$		0.24	0.4	V	$I_C = 2.0\text{ mA}$, $I_F = 16\text{ mA}$
Bandwidth (see note 2)	B_W		150		KHz	$I_C = 2\text{ mA}$, $V_{CE} = 10\text{ V}$, $R_L = 100\ \Omega$ (Circuit No. 1)

SWITCHING TIMES			TYP.		UNITS	TEST CONDITIONS
Saturated						
t on (from 5 V to 0.8 V)	$t_{on(SAT)}$		10		μs	$R_L = 2\text{ K}\Omega$, $I_F = 15\text{ mA}$, $V_{CC} = 5\text{ V}$
t off (from SAT to 2.0 V)	$t_{off(SAT)}$		30			$R_B = \text{open}$ (Circuit No. 2)
Non-Saturated						
t on (from 5 V to 0.8 V)	$t_{on(SAT)}$		10		μs	$R_L = 2\text{ K}\Omega$, $I_F = 20\text{ mA}$, $V_{CC} = 5\text{ V}$
t off (from SAT to 2.0 V)	$t_{off(SAT)}$		27			$R_B = 100\text{ K}\Omega$ (Circuit No. 2)
Base	Rise Time	t_r	300		ns	$R_L = 1\text{ K}\Omega$, $V_{CB} = 10\text{ V}$
	Fall Time	t_f	300		ns	

TYPICAL ELECTRO-OPTICAL CHARACTERISTIC CURVES (25°C Free Air Temperature Unless Otherwise Specified)

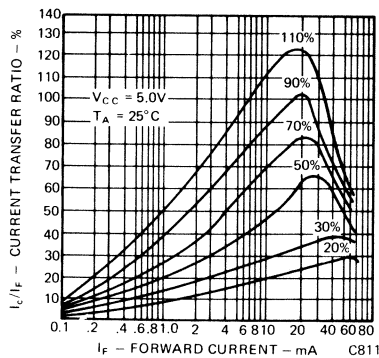
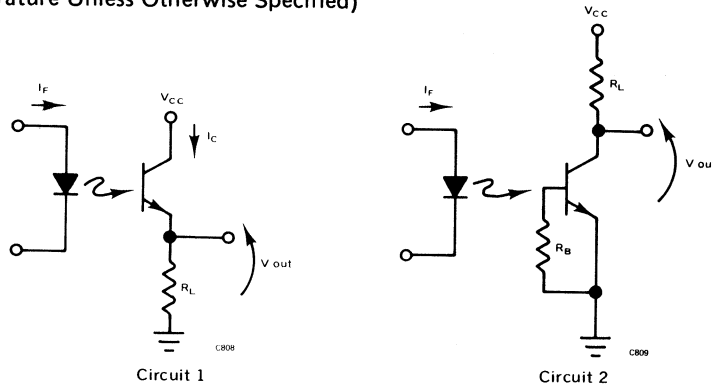


Fig. 1. Current Transfer Ratio vs. Forward Current

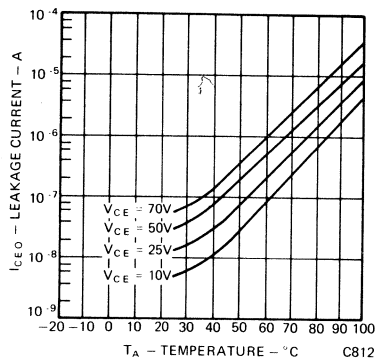


Fig. 2. Dark Current vs. Temperature

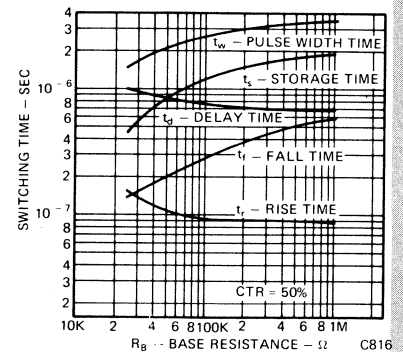


Fig. 3. Switching Time vs. Base Resistance

TYPICAL ELECTRO-OPTICAL CHARACTERISTIC CURVES
(25° C Free Air Temperature Unless Otherwise Specified)

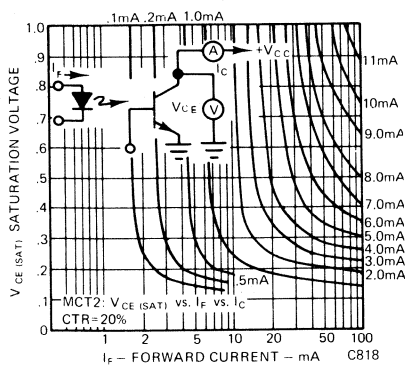


Fig. 4. Saturation Voltage vs. Forward Current

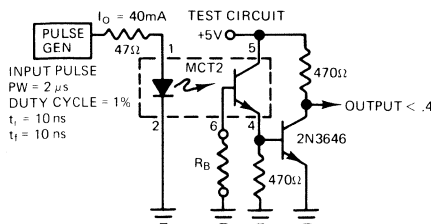


Fig. 5. Circuit for Figure 3

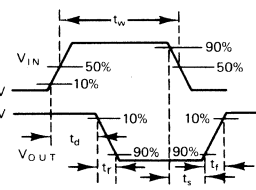


Fig. 6. Waveforms for Figure 3

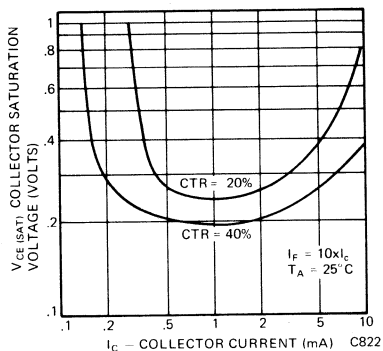


Fig. 7. Saturation Voltage vs. Collector Current

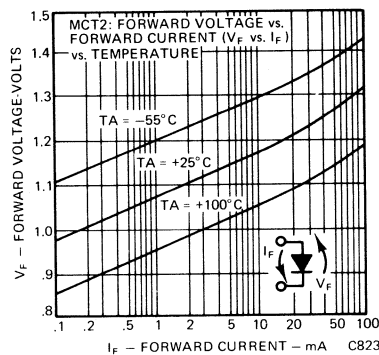


Fig. 8. Forward Voltage vs. Forward Current

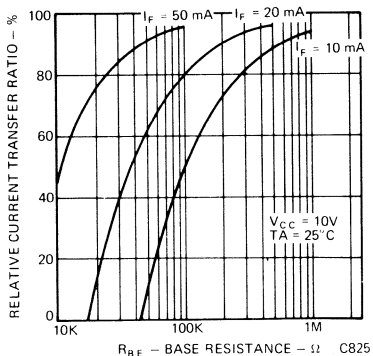


Fig. 9. Sensitivity vs. Base Resistance

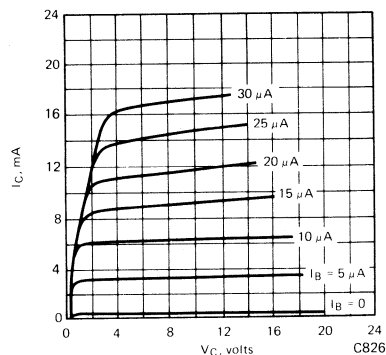


Fig. 10. Detector Typical h_{fe} Curves

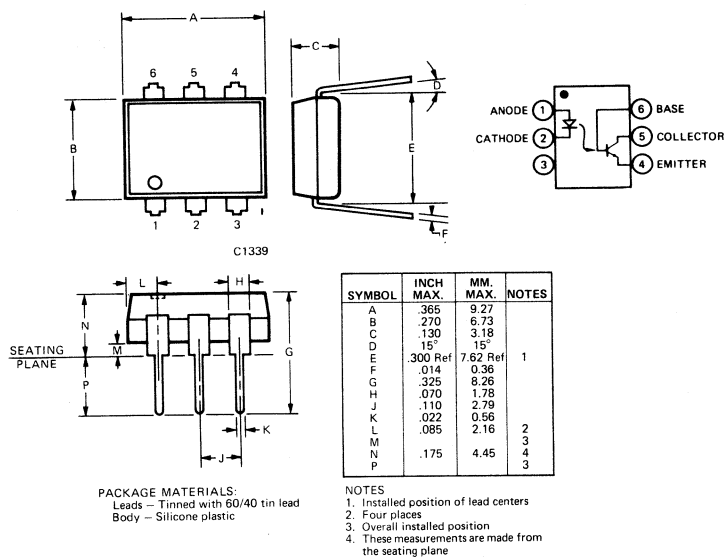
NOTES

1. The current transfer ratio (I_C/I_F) is the ratio of the detector collector current to the LED input current with V_{CE} at 10 volts.
2. The frequency at which i_c is 3 dB down from the 1 kHz value.
3. Rise time (t_r) is the time required for the collector current to increase from 10% of its final value, to 90%.
Fall time (t_f) is the time required for the collector current to decrease from 90% of its initial value, to 10%.
4. Use a 100 M Ω resistor R_{BE} for test stability. *otes Handbook.*
5. Normalized CTR degradation = $\frac{CTR_0 - CTR}{CTR_0}$

PRODUCT DESCRIPTION

The MCT2 is a NPN silicon planar phototransistor optically coupled to a gallium arsenide diode. It is mounted in a six-lead plastic DIP package.

PACKAGE DIMENSIONS



APPLICATIONS

- Utility/economy isolator
- AC line/digital logic isolator
- Digital logic/digital logic isolator
- Telephone/telegraph line receiver
- Twisted pair line receiver
- High frequency power supply feedback control
- Relay contact monitor
- Power supply monitor
- UL Approved Product File E50151

ABSOLUTE MAXIMUM RATINGS

Input Diode

- Forward DC current 60 mA
- Reverse current 10 μ A
- Peak forward current
(1 μ s pulse, 300 pps) 3.0 A
- Power dissipation at 25°C ambient 200 mW
- Derate linearly from 25°C 2.6 mW/°C

Output Transistor

- Power dissipation at 25°C ambient 200 mW

Storage temperature -55°C to 150°C
Operating temperature -55°C to 100°C
Lead temperature (Soldering, 10 sec) 260°C

- Derate linearly from 25°C 2.6 mW/°C
- Surge isolation rating 3550 VDC
- 2500 VRMS
- Steady state isolation rating 3150 VDC
- 2250 VRMS
- Total package power dissipation at
25°C ambient (LED plus detector) 250 mW
- Derate linearly from 25°C 3.3 mW/°C
- Collector-Emitter Current (I_{CE}) 50 mA

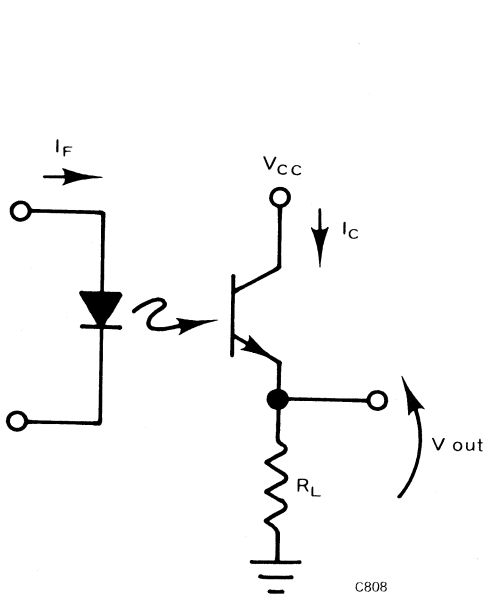
ELECTRO-OPTICAL CHARACTERISTICS (25°C Free Air Temperature Unless Otherwise Specified)

CHARACTERISTIC	SYMBOL	GUAR. MIN.	TYP.	GUAR. MAX.	UNITS	TEST CONDITIONS
Input Diode						
Forward Voltage	V_F		1.25	1.50	V	$I_F = 20$ mA
Reverse Breakdown Voltage	BV_R	3.0	25		V	$I_R = 10$ μ A
Junction Capacitance	C_J		50		pF	$V_F = 0$ V
Reverse Leakage Current	I_R		.01	10	μ A	$V_R = 3.0$ V
Output Transistor						
DC Forward Current Gain	h_{FE}	100	250			$V_{CE} = 5$ V, $I_C = 100$ μ A
Collector To Emitter Break-down Volt.	BV_{CEO}	30	85		V	$I_C = 1.0$ mA, $I_F = 0$
Collector To Base Break-down Voltage	BV_{CBO}	70	165		V	$I_C = 10$ μ A
Emitter to Collector Break-down Voltage	BV_{ECO}	7	14		V	$I_C = 100$ μ A, $I_F = 0$
Collector To Emitter, Leakage Current	I_{CEO}		5	50	nA	$V_{CE} = 10$ V, $I_F = 0$, Note 5
Collector To Base Leakage Current	I_{CBO}		0.1	20	nA	$V_{CB} = 10$ V, $I_F = 0$

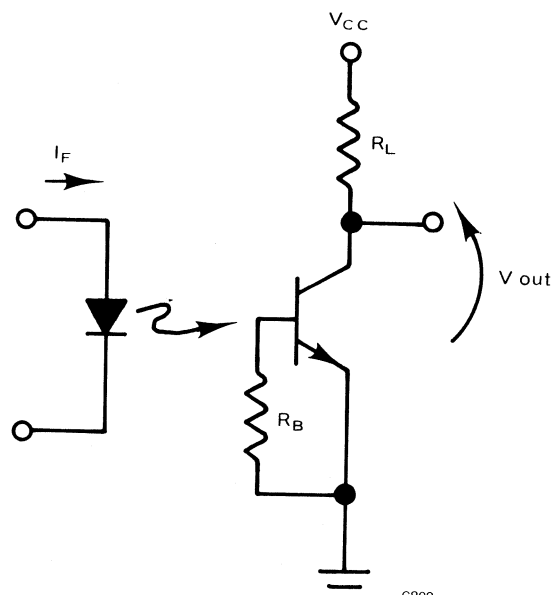
ELECTRO-OPTICAL CHARACTERISTICS (25°C Free Air Temperature Unless Otherwise Specified)

CHARACTERISTIC	SYMBOL	GUAR. MIN.	TYP.	GUAR. MAX.	UNITS	TEST CONDITIONS
Capacitance Collector To Emitter	C_{CEO}		8		pF	$V_{CE}=0$
Capacitance Collector To Base	C_{CBO}		20		pF	$V_{CB}=10\text{ V}$
Capacitance Emitter To Base	C_{EBO}		10		pF	$V_{BE}=0$
Coupled						
DC Collector Current Transfer Ratio	I_C/I_F	20	60		%	$V_{CE}=10\text{ V}$, $I_F=10\text{ mA}$, Note 1
DC Base Current Transfer Ratio	I_B/I_F		.35		%	$V_{CB}=10\text{ V}$, $I_F=10\text{ mA}$
Isolation Voltage	$B_V(I-O)$	2500 3500			V_{RMS} VDC	$f = 60\text{ Hz}$
Isolation Resistance		10^{11}	10^{12}		Ω	$V_{I-O}=500\text{ V}$
Isolation Capacitance			.5		pF	$f=1\text{MHz}$
Collector-Emitter, Saturation Voltage	$V_{CE(sat)}$		0.24	0.4	V	$I_C = 2.0\text{ mA}$, $I_F = 16\text{ mA}$
Bandwidth (see note 2)	B_W		150		KHz	$I_C = 2\text{ mA}$, $V_{CE} = 10\text{ V}$, $R_L = 100\ \Omega$ (Circuit No. 1)

SWITCHING TIMES			TYP.	UNITS	TEST CONDITIONS
Non-Saturated Collector	Delay Time	t_d	0.5	μs	$R_L = 100\ \Omega$, $I_C = 2\text{ mA}$, $V_{CC} = 10\text{ V}$ (Circuit No. 1)
	Rise Time	t_r	2.5		
	Storage Time	t_s	0.1		
	Fall Time	t_f	2.6		
Non-Saturated Collector	Delay Time	t_d	2.0	μs	$R_L = 1\text{ K}\Omega$, $I_C = 2\text{ mA}$, $V_{CC} = 10\text{ V}$ (Circuit No. 1)
	Rise Time	t_r	15		
	Storage Time	t_s	0.1		
	Fall Time	t_f	15		
Saturated	t_{on} (from 5 V to 0.8 V)	$t_{on(SAT)}$	5	μs	$R_L = 2\text{ K}\Omega$, $I_F = 15\text{ mA}$, $V_{CC} = 5\text{ V}$ $R_B = \text{open}$ (Circuit No. 2)
	t_{off} (from SAT to 2.0 V)	$t_{off(SAT)}$	25		
Saturated	t_{on} (from 5 V to 0.8 V)	$t_{on(SAT)}$	5	μs	$R_L = 2\text{ K}\Omega$, $I_F = 20\text{ mA}$, $V_{CC} = 5\text{ V}$ $R_B = 100\text{ K}\Omega$ (Circuit No. 2)
	t_{off} (from SAT to 2.0 V)	$t_{off(SAT)}$	18		
Non-Saturated Base	Rise Time	t_r	175	ns	$R_L = 1\text{ K}\Omega$, $V_{CB} = 10\text{ V}$
	Fall Time	t_f	175		



Circuit 1



Circuit 2

TYPICAL ELECTRO-OPTICAL CHARACTERISTIC CURVES
(25°C Free Air Temperature Unless Otherwise Specified)

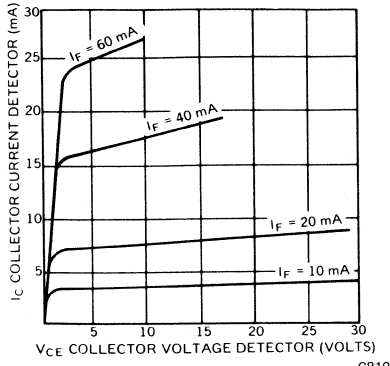


Fig. 1 Collector Current vs. Collector Voltage (for Typical CTR 30%)

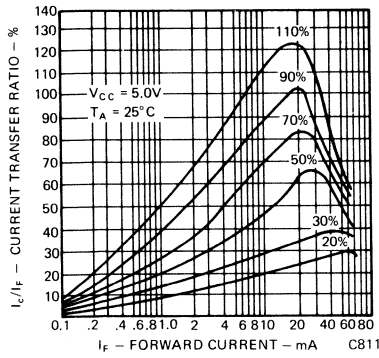


Fig. 2 Current Transfer Ratio vs. Forward Current

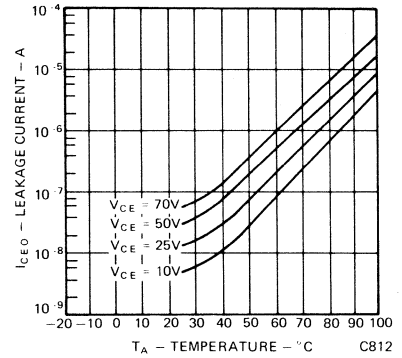


Fig. 3 Dark Current vs. Temperature

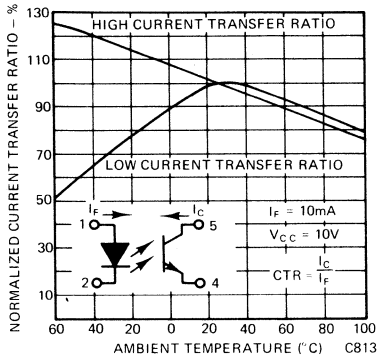


Fig. 4 Current Transfer Ratio vs. Temperature

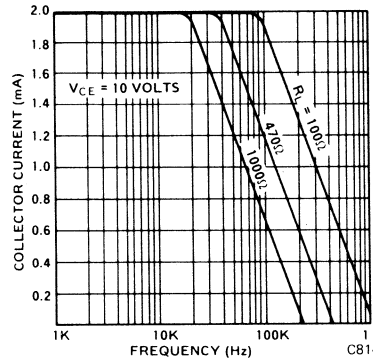


Fig. 5 Collector Current vs. Frequency

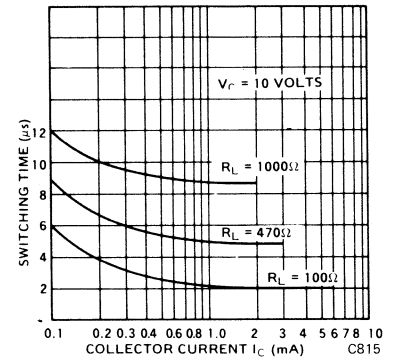


Fig. 6 Switching Time vs. Collector Current

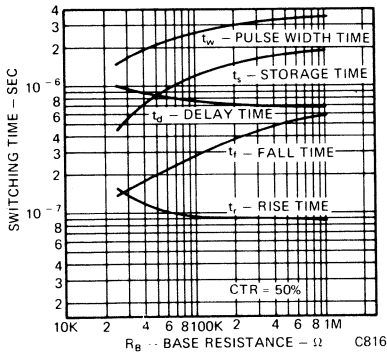


Fig. 7 Switching Time vs. Base Resistance

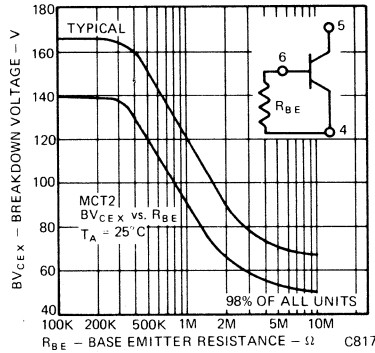


Fig. 8 Collector - Emitter Breakdown Voltage vs. Base Resistance

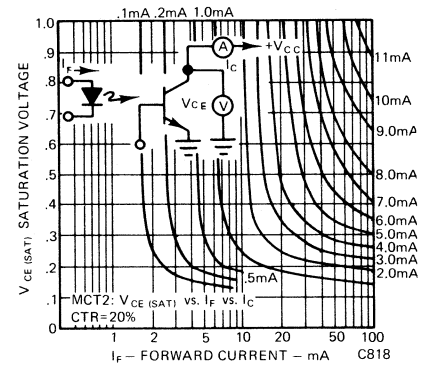


Fig. 9 Saturation Voltage vs. Forward Current

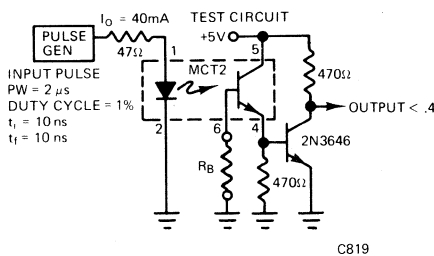


Fig. 10 Circuit for Figure 7

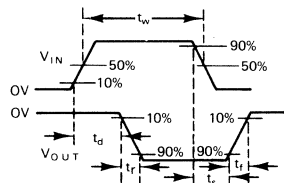


Fig. 11 Waveforms for Figure 7

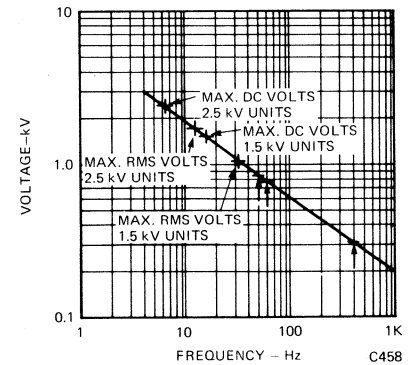


Fig. 12 Steady-State AC Voltage Limit of Isolation Dielectric

TYPICAL ELECTRO-OPTICAL CHARACTERISTIC CURVES
(25° C Free Air Temperature Unless Otherwise Specified)

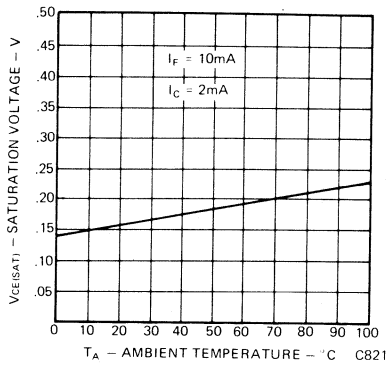


Fig. 13 Saturation Voltage vs. Temperature

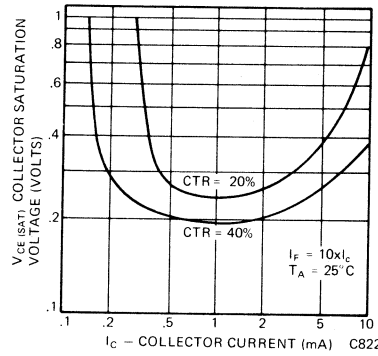


Fig. 14 Saturation Voltage vs. Collector Current

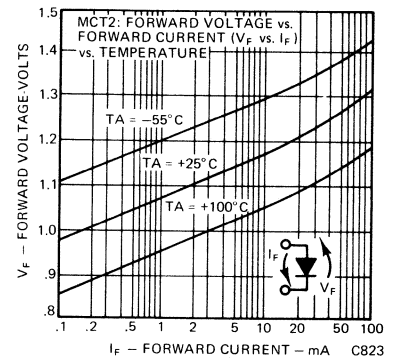


Fig. 15 Forward Voltage vs. Forward Current

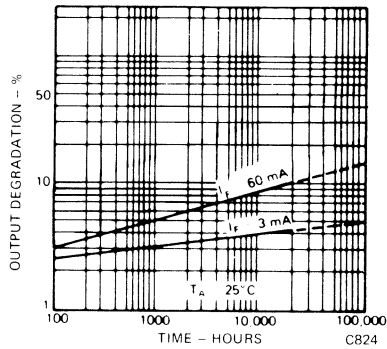


Fig. 16 Lifetime vs. Forward Current

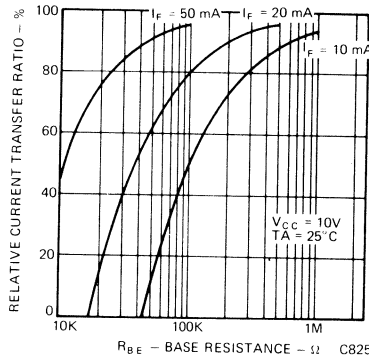


Fig. 17 Sensitivity vs. Base Resistance

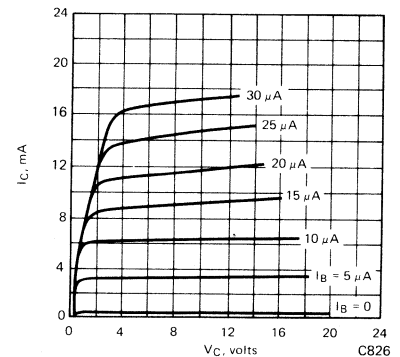
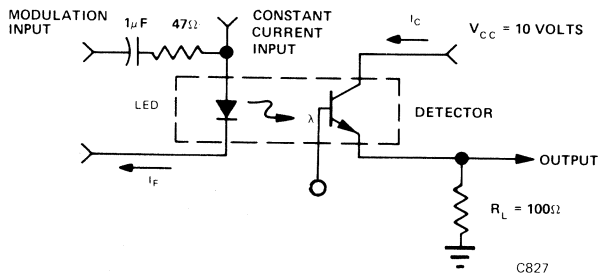
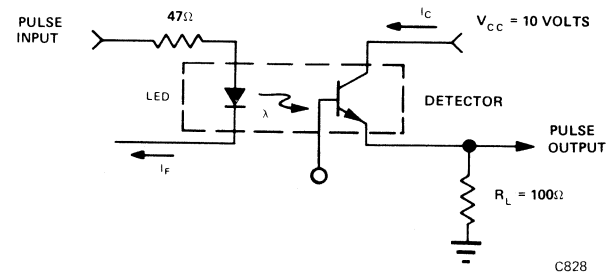


Fig. 18 Detector Typical h_{fe} Curves

OPERATING SCHEMATICS



Modulation Circuit Used to Obtain Output vs Frequency Plot



Circuit Used to Obtain Switching Time vs Collector Current Plot

NOTES

1. The current transfer ratio (I_C/I_F) is the ratio of the detector collector current to the LED input current with V_{CE} at 10 volts.
2. The frequency at which i_c is 3 dB down from the 1 kHz value.
3. Rise time (t_r) is the time required for the collector current to increase from 10% of its final value, to 90%.
Fall time (t_f) is the time required for the collector current to decrease from 90% of its initial value, to 10%.
4. For design information send for Application Notes Handbook.
5. Use a 100 MΩ resistor R_{BE} for test stability.
6. Normalized CTR degradation = $\frac{CTR_0 - CTR}{CTR_0}$

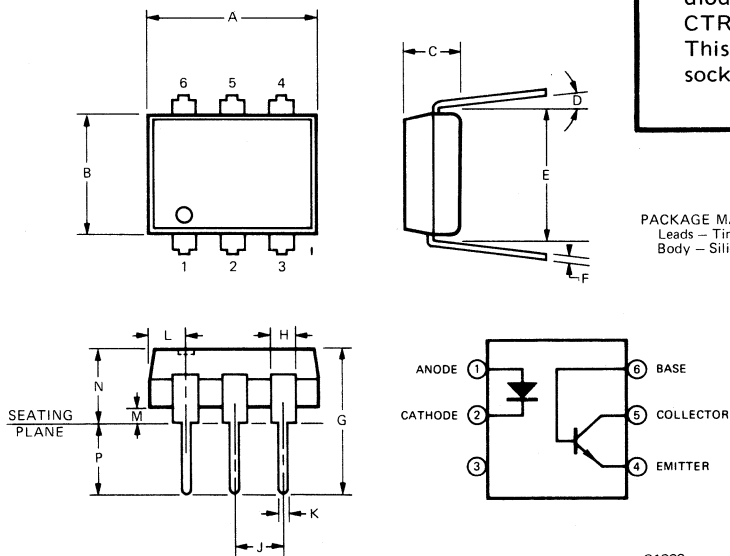
FEATURES

- TTL compatible 1-10 gate loads
- High CTR with transistor output
MCT210—150% min.
- Specified CTR over temperature range
- Good logic load characteristics
 $V_{OL} = 0.4 \text{ V @ } 1.6 \text{ mA to } 16 \text{ mA}$
output sinking (I_{OL})
- UL recognized (File #50151)

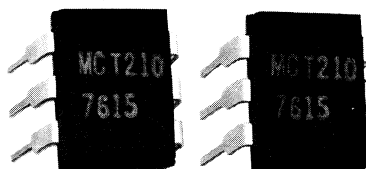
APPLICATIONS

- Digital logic isolation
- Line receivers
- Feedback control circuits
- Monitoring circuits

PACKAGE DIMENSIONS



PACKAGE MATERIALS:
Leads - Tinned with 60/40 tin lead
Body - Silicone plastic



PRODUCT DESCRIPTION

The MCT210 incorporates a NPN silicon planar phototransistor optically coupled to a gallium arsenide diode emitter. The MCT210 has a specified minimum CTR of 50%, saturated, and 150%, unsaturated. This unit is mounted in a six-lead plastic DIP socket.

SYMBOL	INCH MAX.	MM. MAX.	NOTES
A	.365	9.27	
B	.270	6.73	
C	.130	3.18	
D	15°	15°	
E	.300 Ref	7.62 Ref	1
F	.014	0.36	
G	.325	8.26	
H	.070	1.78	
J	.110	2.79	
K	.022	0.56	
L	.085	2.16	2
M			3
N	.175	4.45	4
P			3

- NOTES
1. Installed position of lead centers
 2. Four places
 3. Overall installed position
 4. These measurements are made from the seating plane

C1339

ABSOLUTE MAXIMUM RATINGS

TOTAL PACKAGE

Storage temperature	-55°C to 150°C
Operating temperature	-55°C to 100°C
Lead temperature (Soldering, 10 sec)	260°C
Total package power dissipation @ 25°C (LED plus detector)	260 mW
Derate linearly from 25°C	3.4 mW/°C
Surge isolation	2500 VDC 1500 VRMS
Steady state isolation	2250 VDC 1250 VRMS

INPUT DIODE

Forward DC current	60 mA
Reverse current	10 µA
Peak forward current (1 µs pulse, 300 pps)	3.0 A
Power dissipation 25°C to 70°C ambient	60 mW
Derate linearly from +70°C	2.0 mW/°C

OUTPUT TRANSISTOR

Power dissipation @ 25°C	200 mW
Derate linearly from 25°C	2.67 mW/°C

ELECTRO-OPTICAL CHARACTERISTICS (0° to +70°C Temperature unless otherwise specified)

INDIVIDUAL COMPONENT CHARACTERISTICS							
	CHARACTERISTIC	SYMBOL	MIN.	TYP.	MAX.	UNITS	TEST CONDITIONS
INPUT DIODE	Forward voltage	V_F		1.25	1.50	V	$I_F = 40 \text{ mA}$
	Forward voltage temp. coefficient			-1.8		$\text{mV}/^\circ\text{C}$	
	Reverse breakdown voltage	BV_R	6.0	15		V	$I_R = 10 \mu\text{A}$
	Junction capacitance	C_J		50		pF	$V_F = 0 \text{ V}, f = 1 \text{ MHz}$
	Reverse leakage current	I_R		.01	10	μA	$V_F = 1 \text{ V}, f = 1 \text{ MHz}$ $V_R = 6.0 \text{ V}$
OUTPUT TRANSISTOR	DC forward current gain	h_{FE}	100	400			$V_{CE} = 5 \text{ V}, I_C = 10 \text{ mA}$
	Breakdown voltage						
	Collector to emitter	BV_{CEO}	30	45		V	$I_C = 1.0 \text{ mA}, I_F = 0$
	Collector to base	BV_{CBO}	70			V	$I_C = 10 \mu\text{A}$
	Emitter to collector	BV_{ECO}	6	8		V	$I_C = 100 \mu\text{A}, I_F = 0$
	Leakage current						
	Collector to emitter	I_{CEO}		5	50	nA	$V_{CE} = 5 \text{ V}, I_F = 0,$ $T_A = +25^\circ\text{C}$
	Capacitance				30	μA	$V_{CE} = 5 \text{ V}, I_F = 0,$
	Collector to emitter			8		pF	$V_{CE} = 0, f = 1 \text{ MHz}$
	Collector to base			20		pF	$V_{CB} = 5, f = 1 \text{ MHz}$
Emitter to base			10		pF	$V_{EB} = 0, f = 1 \text{ MHz}$	
COUPLED CHARACTERISTICS							
	CHARACTERISTIC	SYMBOL	MIN.	TYP.	MAX.	UNITS	TEST CONDITIONS
DC	Current transfer ratio, collector to emitter MCT210	I_{CE}/I_F	50	70		%	$V_{CE} = 0.4 \text{ V}, I_F = 3.2 \text{ mA}$ to 32 mA
	Current transfer ratio, collector to base	I_{CB}/I_F	150	225		%	$V_{CE} = 5.0 \text{ V}, I_F = 10 \text{ mA}$ $V_{CB} = 5.0 \text{ V}, I_F = 10 \text{ mA}$
	Saturation voltage collector to emitter MCT210	$V_{CE(SAT)}$		0.2	0.4	V	$I_C = 16 \text{ mA}, I_F = 32 \text{ mA}$
ISOLATION	Isolation voltage		2500			VDC	Relative humidity $\leq 50\%$, $T_A = +25^\circ\text{C}, I_{I-O} \leq 10 \mu\text{A}$
	Isolation resistance		10^{11}	5×10^{12}		Ω	$V_{I-O} = 500 \text{ VDC},$ $T_A = +25^\circ\text{C}$
	Isolation capacitance			1.0		pF	$f = 1 \text{ MHz}$
SWITCHING TIMES	Non-saturated						
	Rise time	t_r		4		μs	$R_L = 100 \Omega, I_C = 2 \text{ mA},$ $V_{CC} = 5 \text{ V}$
	Fall time	t_f		5		μs	See Figures 17 and 18
	Saturated						
	Rise time	t_r		2.5		μs	$R_L = 560 \Omega, I_F = 16 \text{ mA}$
	Fall time	t_f		25		μs	See Figures 17 and 18
	Propagation delay						
High to low	$T_{PD(HL)}$		2		μs	$R_L = 2.7\text{K}, I_F = 16 \text{ mA}$	
Low to high	$T_{PD(LH)}$		10		μs	See Figures 17 and 18	

All Typ. readings @ +25°C

ELECTRICAL CHARACTERISTIC CURVES (25°C Free air temperature unless specified)

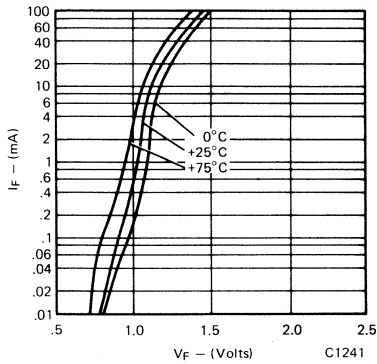


Fig. 1. Forward Voltage vs. Forward Current

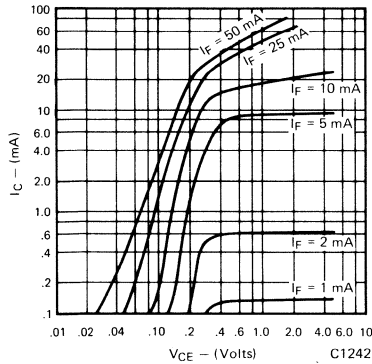


Fig. 2. Collector Current vs. Collector to Emitter Voltage

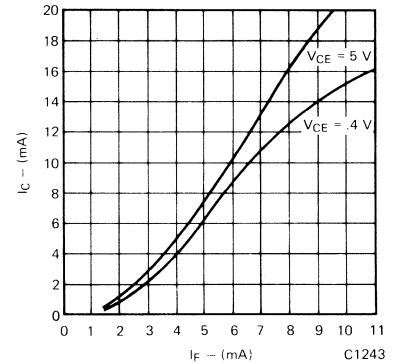


Fig. 3. Collector Current vs. Forward Current

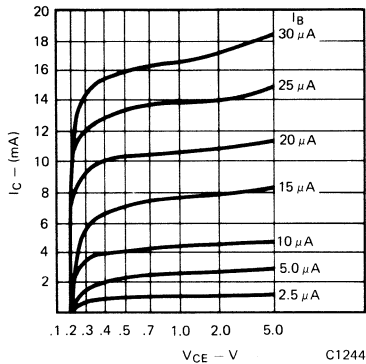


Fig. 4. Collector Current vs. Collector to Emitter Voltage

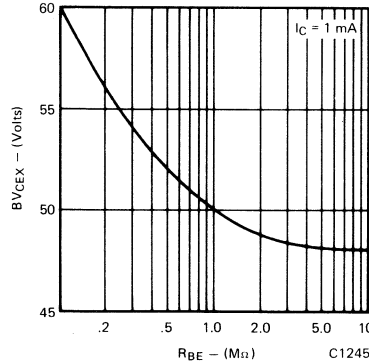


Fig. 5. Collector to Emitter Breakdown Voltage vs. Base to Emitter Resistance

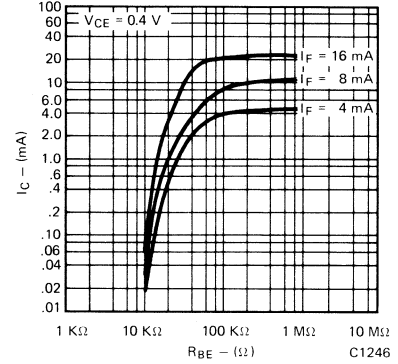


Fig. 6. Saturated CTR vs. Base to Emitter Resistance

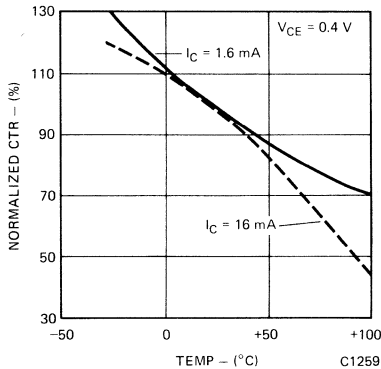


Fig. 7. Current Transfer Ratio (saturated) vs. Temperature

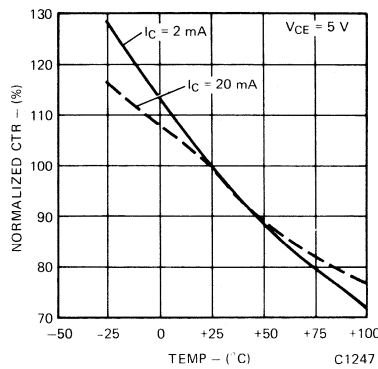


Fig. 8. Current Transfer Ratio (unsaturated) vs. Temperature

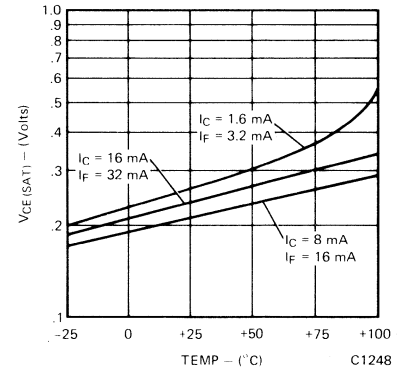


Fig. 9. Collector to Emitter Saturation Voltage vs. Temperature

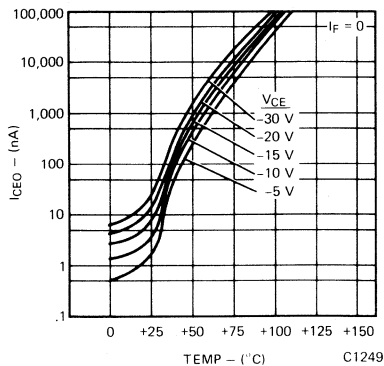


Fig. 10. Collector to Emitter Leakage Current vs. Temperature

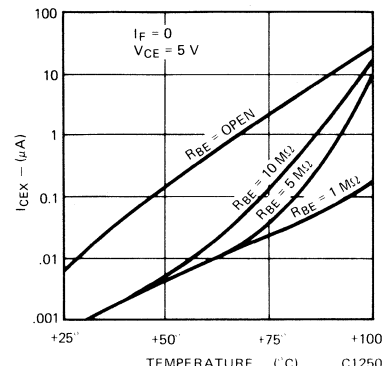


Fig. 11. Collector to Emitter Leakage Current vs. Temperature

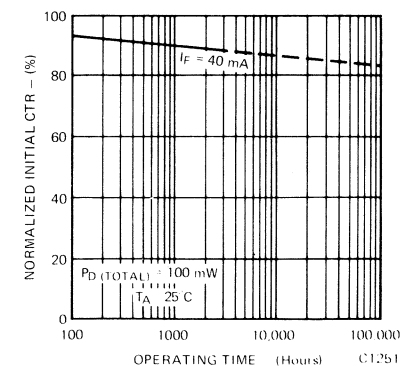


Fig. 12. Current Transfer Ratio vs. Operating Time

SWITCHING CHARACTERISTICS

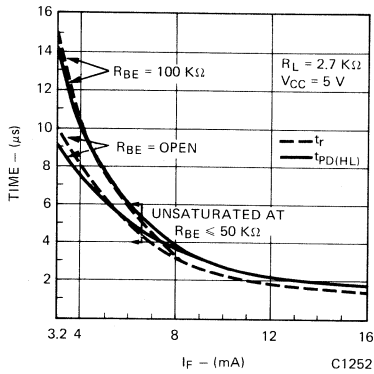


Fig. 13. Switch-on Time vs. I_F Drive (saturated)

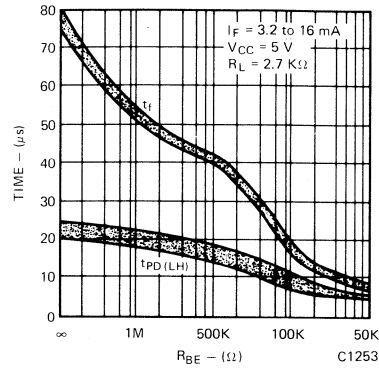


Fig. 14. Switch-off Time vs. Base to Emitter Resistance (saturated)

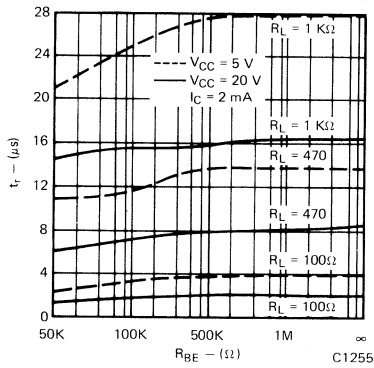


Fig. 15. Rise Time vs. Base to Emitter Resistance (non-saturated)

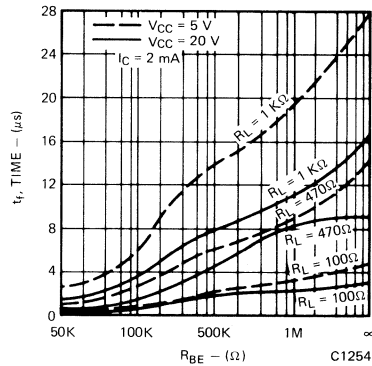


Fig. 16. Fall Time vs. Base to Emitter Resistance (non-saturated)

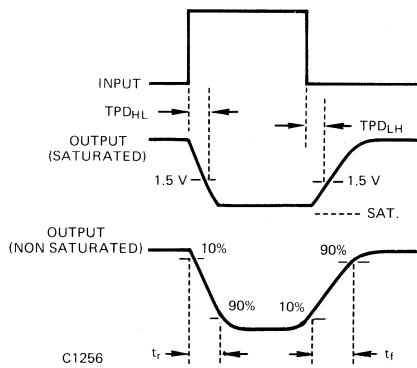


Fig. 17. Switching Time Waveforms

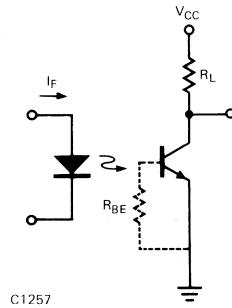


Fig. 18. Switching Time Test Circuits

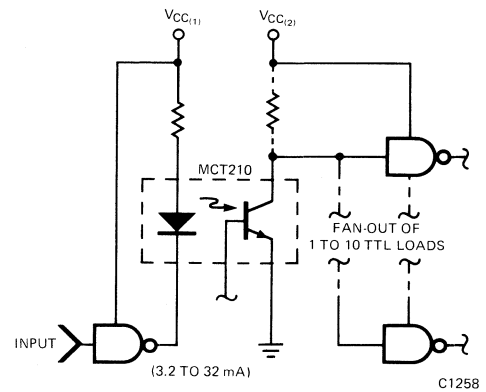
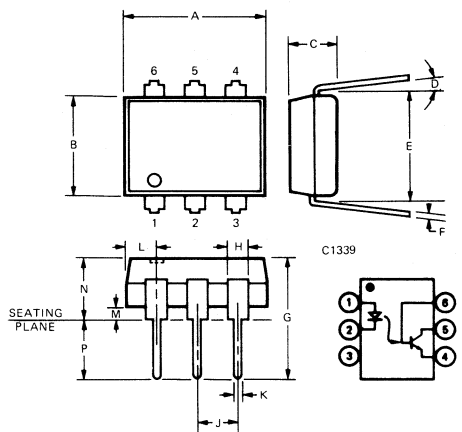


Fig. 19. Typical TTL Interface at Operating Temperatures of 0° to 70° C

PRODUCT DESCRIPTION

The MCT26 is a NPN silicon planar phototransistor optically coupled to a gallium arsenide diode. It is mounted in a six lead plastic DIP.

PACKAGE DIMENSIONS



SYMBOL	INCH MAX.	MM. MAX.	NOTES
A	.365	9.27	
B	.270	6.73	
C	.130	3.18	
D	15°	15°	
E	.300 Ref	7.62 Ref	1
F	.014	0.36	
G	.325	8.26	
H	.070	1.78	
J	.110	2.79	
K	.022	0.56	
L	.085	2.16	2
M			3
N			4
P	.175	4.45	3

NOTES
 1. Installed position of lead centers
 2. Four places
 3. Overall installed position
 4. These measurements are made from the seating plane

PACKAGE MATERIALS:
 Leads - Tinned with 60/40 tin lead
 Body - Silicone plastic

APPLICATIONS

- AC line/digital logic isolator
- Digital logic/digital logic isolator
- Telephone/telegraph line receiver
- Twisted pair line receiver
- High frequency power supply feedback control
- Relay contact monitor
- Power supply monitor

ABSOLUTE MAXIMUM RATINGS

<p>Input Diode</p> <p>Forward DC current 60 mA</p> <p>Reverse current 10 μA</p> <p>Peak forward current (1 μs pulse, 300 pps) 3.0 A</p> <p>Power dissipation at 25°C ambient 200 mW</p> <p>Derate linearly from 25°C 2.6 mW/°C</p>	<p>Storage Temperature -55°C to 150°C</p> <p>Operating temperature -55°C to 100°C</p> <p>Lead temperature (Soldering, 10 sec) 260°C</p>	<p>Output Transistor</p> <p>Power Dissipation at 25°C ambient 200 mW</p> <p>Derate linearly from 25°C 2.6 mW/°C</p> <p>Input to output voltage 1500 volts</p> <p>Total package power dissipation at 25°C ambient (LED plus detector) 250 mW</p> <p>Derate linearly from 25°C 3.3 mW/°C</p>
---	---	---

ELECTRO-OPTICAL CHARACTERISTICS (25°C Free Air Temperature Unless Otherwise Specified)

CHARACTERISTICS	MIN.	TYP.	MAX.	UNITS	TEST CONDITIONS
Emitter					
Forward voltage V_F	—	1.25	1.5	V	$I_F = 20$ mA
Reverse current I_R	—	.15	10	μ A	$V_R = 3.0$ V
Capacitance C_J	—	50	—	pF	$V = 0$
Detector					
h_{FE}	—	150	—		$V_{CE} = 5$ V, $I_C = 100$ μ A
BV_{CEO}	30	85	—	V	$I_C = 1.0$ mA, $I_F = 0$
BV_{ECO}	7	12	—	V	$I_C = 100$ μ A, $I_F = 0$
I_{CEO}	—	5	100	nA	$V_{CE} = 5$ V, $I_F = 0$
Capacitance Collector-emitter C_{CE}	—	8	—	pF	$V_{CE} = 0$
BV_{CBO}	30	165	—	V	$I_C = 10$ μ A
I_{CBO} (dark)	—	1	100	nA	$V_{CB} = 5$ V, $I_F = 0$
Coupled					
DC current transfer ratio CTR	6	14	—	%	$I_F = 10$ mA, $V_{CE} = 10$ V, note 1
Breakdown voltage	1500	2500	—	VDC	
	800	—	—		VAC, RMS @ $f = 60$ Hz
Resistance emitter-detector R_{I-O}	10^{11}	10^{12}	—	Ω	$V_{E-D} = 500$ VDC
V_{CE} (SAT)	—	0.2	0.3	V	$I_C = 250$ μ A, $I_F = 20$ mA
	—	0.2	0.5	V	$I_C = 1.6$ mA, $I_F = 60$ mA
Capacitance LED to detector C_{I-O}	—	0.5	—	pF	$f = 1$ MHz
Bandwidth (see figure 5) B_W	—	300	—	kHz	$I_C = 2$ mA, note 2
Rise time + fall time (see oper. schematics) t_r, t_f	2	—	—	μ s	$I_C = 2$ mA, $V_{CE} = 10$ V, note 3

TYPICAL ELECTRO-OPTICAL CHARACTERISTIC CURVES
(25°C Free Air Temperature Unless Otherwise Specified)

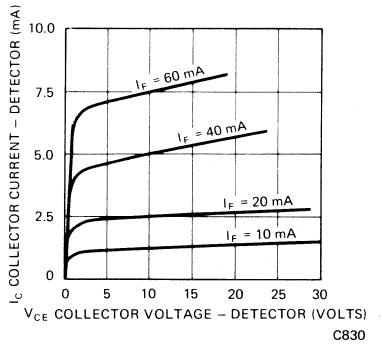


Fig. 1 Detector Output Characteristics

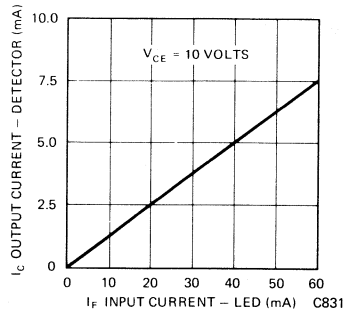


Fig. 2 Input Current vs. Output Current

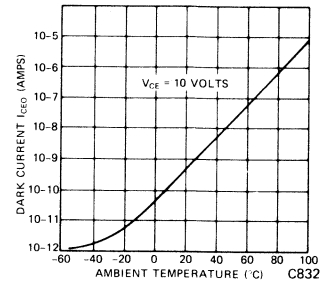


Fig. 3 Dark Current vs. Temperature (°C)

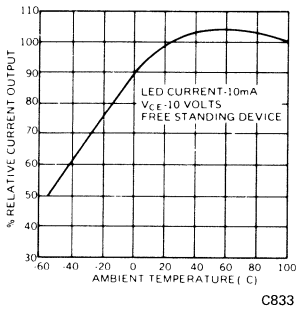


Fig. 4 Current Output vs. Temperature

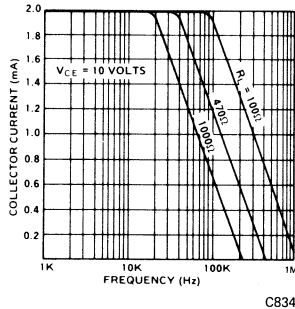


Fig. 5 Output vs. Frequency

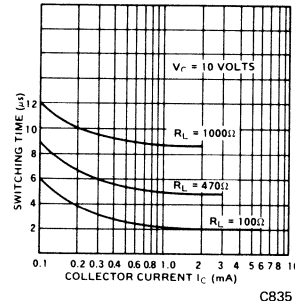


Fig. 6 Switching Time vs. Collector Current

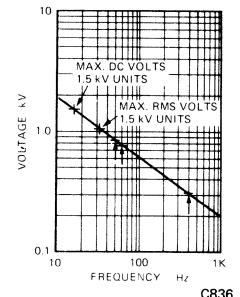
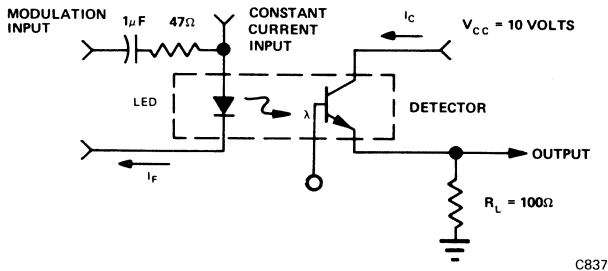


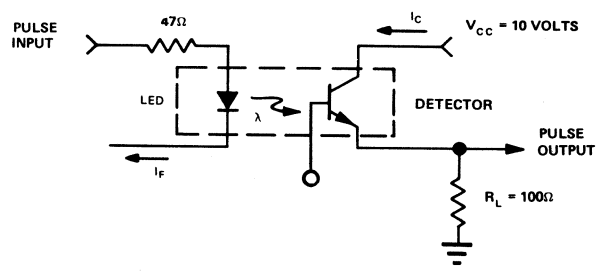
Fig. 7 Steady-State AC Voltage Limit of Isolation Dielectric

For additional characteristic curves, see figures 2, 3, 5, 6, 8, 11, 12, & 13 on MCT2.

OPERATING SCHEMATICS



Modulation Circuit Used to Obtain Output vs. Frequency Plot



Circuit Used to Obtain Switching Time vs. Collector Current Plot

NOTES

1. The current transfer ratio (I_C/I_F) is the ratio of the detector collector current to the LED input current with V_{CE} at 10 volts.
2. The frequency at which i_c is 3 dB down from the 1 kHz value.
3. Rise time (t_r) is the time required for the collector current to increase from 10% of its final value to 90%. Fall time (t_f) is the time required for the collector current to decrease from 90% of its initial value to 10%.

FEATURE SPECIFICATIONS

- **Controlled Current Transfer Ratio** – 45% to 90% (specified conditions)
- **Maximum Turn-on time** – 7 μ seconds (specified condition)
- **Maximum Turn-off time** – 7 μ seconds (specified condition)
- **Surge Isolation Rating** – 3550 volts DC 2500 volts AC, rms
- **Steady-state Isolation Rating** – 3150 volts DC 2250 volts AC, rms
- **Underwriters Laboratory (U.L.) recognized** – File E50151

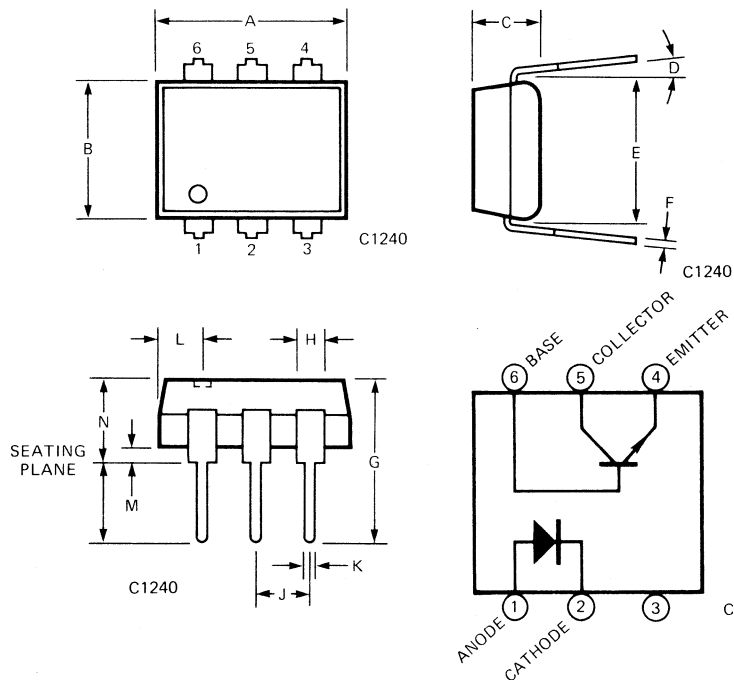
DESCRIPTION

The MCT271 is a phototransistor-type optically coupled isolator. An infrared emitting diode manufactured from specially grown gallium arsenide is selectively coupled with an NPN silicon phototransistor. The device is supplied in a standard plastic six-pin dual-in-line package.

APPLICATIONS

- Switching networks
- Power supply regulators
- Digital logic inputs
- Microprocessor inputs
- Appliance sensor systems

PACKAGE DIMENSIONS



SYMBOL	INCHES MAX.	mm MAX.	NOTES
A	.365	9.27	
B	.270	6.73	
C	.130	3.18	
D	15°	15°	
E	.300 Ref.	7.62 Ref.	1
F	.014	0.36	
G	.325	8.26	
H	.070	1.78	
J	.110	2.79	
K	.022	0.56	
L	.085	2.16	2
M			3
N	.175	4.45	4
P			3

- NOTES
1. INSTALLED POSITION OF LEAD CENTERS
 2. FOUR PLACES
 3. OVERALL INSTALLED POSITION
 4. THESE MEASUREMENTS ARE MADE FROM THE SEATING PLANE

ELECTRO-OPTICAL CHARACTERISTICS (0° to +70°C Temperature unless otherwise specified)

TRANSFER CHARACTERISTICS							
	CHARACTERISTIC	SYMBOL	MIN.	TYP.	MAX.	UNITS	TEST CONDITIONS
DC	Current Transfer Ratio, collector to emitter	I_{CE}/I_F	45	67	90	%	$I_F = 10 \text{ mA}; V_{CE} = 10 \text{ V}$
			12.5			%	$I_F = 16 \text{ mA}; V_{CE} = 0.4 \text{ V}$
	Current Transfer Ratio, collector to base	I_{CB}/I_F		.15		%	$I_F = 10 \text{ mA}; V_{CB} = 10 \text{ V}$
	Saturation voltage	$V_{CE(SAT)}$.14	.40	V	$I_F = 16 \text{ mA}; I_C = 2 \text{ mA}$
SWITCHING TIMES	Non-saturated Turn-on time	t_{on}		4.9	7	μs	$R_L = 100 \Omega; I_C = 2 \text{ mA};$ $V_{CC} = 5 \text{ V}$
	Turn-off time	t_{off}		4.5	7	μs	See figures 11, 13
	Saturated Turn-on time	t_{on}		5.2		μs	$I_F = 16 \text{ mA}; R_L = 1.9 \text{ K}\Omega$
	Turn-off time (Approximates a typical TTL interface)	t_{off}		38		μs	See figures 12, 14
	Turn-on time	t_{on}		4.9		μs	$I_F = 16 \text{ mA}; R_L = 4.7 \text{ K}\Omega$
	Turn-off time (Approximates a typical low power TTL interface)	t_{off}		90		μs	See figures 12, 14
ISOLATION	Surge isolation	V_{iso}	3550			VDC	Relative humidity $\leq 50\%$, $T_A = +25^\circ\text{C}, I_{I-O} \leq 10 \mu\text{A}$ 1 second
	Steady state isolation	V_{iso}	2500			VAC-rms	1 second
			3150			VDC	Relative humidity $\leq 50\%$, $T_A = +25^\circ\text{C}, I_{I-O} \leq 10 \mu\text{A}$ 1 minute
	Isolation resistance	R_{iso}	2250 10^{11}				VAC-rms ohms
Isolation capacitance	C_{iso}		.5			pF	$f = 1 \text{ MHz}$

INDIVIDUAL COMPONENT CHARACTERISTICS								
	CHARACTERISTIC	SYMBOL	MIN.	TYP.	MAX.	UNITS	TEST CONDITIONS	
INPUT DIODE	Forward voltage	V_F		1.20	1.50	V	$I_F = 20 \text{ mA}$	
	Forward voltage temp. coefficient			-1.8		mV/°C		
	Reverse breakdown voltage	BV_R	3.0	25		V	$I_R = 10 \mu\text{A}$	
	Junction capacitance	C_J		50			pF	$V_F = 0 \text{ V}, f = 1 \text{ MHz}$
				65			pF	$V_F = 1 \text{ V}, f = 1 \text{ MHz}$
Reverse leakage current	I_R		.35	10		μA	$V_R = 3.0 \text{ V}$	
OUTPUT TRANSISTOR	DC forward current gain	h_{FE}	100	420			$V_{CE} = 5 \text{ V}, I_C = 100 \mu\text{A}$	
	Breakdown voltage							
	Collector to emitter	BV_{CEO}	30	45		V	$I_C = 1.0 \text{ mA}, I_F = 0$	
	Collector to base	BV_{CBO}	70	130		V	$I_C = 10 \mu\text{A}$	
	Emitter to collector	BV_{ECO}	7	10		V	$I_C = 100 \mu\text{A}, I_F = 0$	
	Leakage current							
	Collector to emitter	I_{CEO}		5	50	nA	$V_{CE} = 10 \text{ V}, I_F = 0,$ $T_A = +25^\circ\text{C}$	
	Capacitance							
Collector to emitter			8			pF	$V_{CE} = 0, f = 1 \text{ MHz}$	
Collector to base			20			pF	$V_{CB} = 5, f = 1 \text{ MHz}$	
Emitter to base			10			pF	$V_{EB} = 0, f = 1 \text{ MHz}$	

ALL TYP. READINGS @ +25°C

ELECTRICAL CHARACTERISTIC CURVES (25°C Free air temperature unless specified)

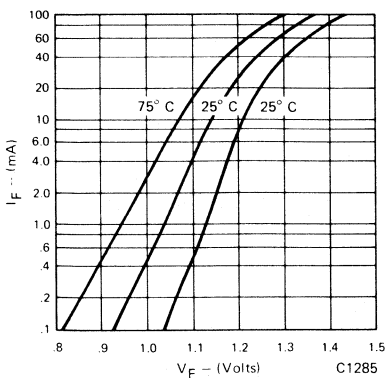


Fig. 1. Forward Voltage vs. Forward Current

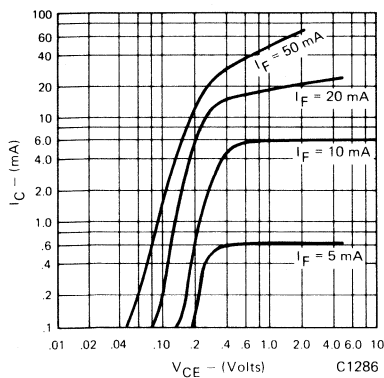


Fig. 2. Collector Current vs. Collector to Emitter Voltage

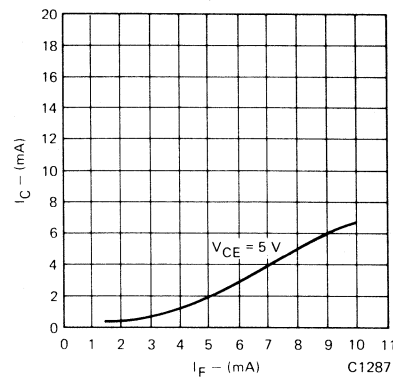


Fig. 3. Collector Current vs. Forward Current

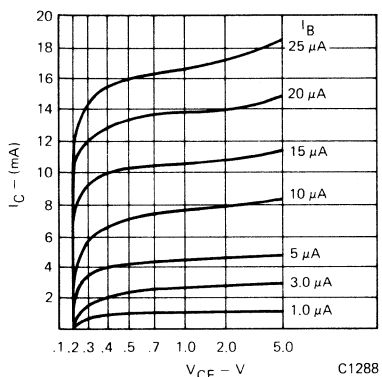


Fig. 4. Collector Current vs. Collector to Emitter Voltage

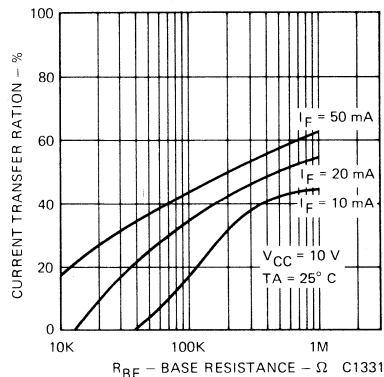


Fig. 5. Sensitivity vs. Base Resistance

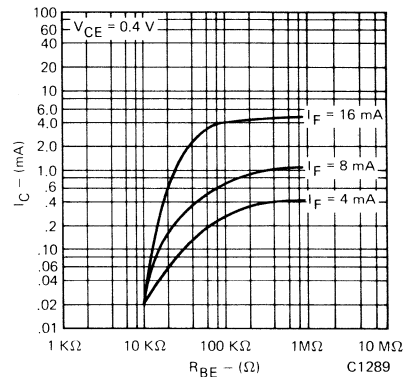


Fig. 6. Saturated CTR vs. Base to Emitter Resistance

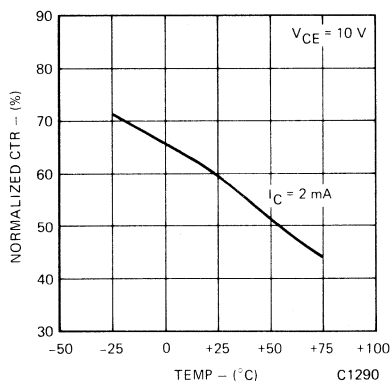


Fig. 7. Current Transfer Ratio (unsaturated) vs. Temperature

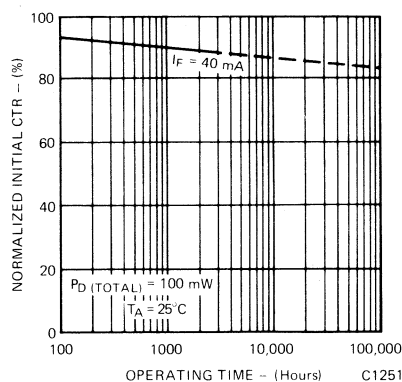


Fig. 8. Current Transfer Ratio vs. Operating Time

ABSOLUTE MAXIMUM RATINGS

TOTAL PACKAGE

- Storage temperature -55°C to 150°C
- Operating temperature -55°C to 100°C
- Lead temperature (Soldering, 10 sec) 260°C
- Total package power dissipation @ 25°C (LED plus detector) 260 mW
- Derate linearly from 25°C 3.4 mW/°C

INPUT DIODE

- Forward DC current 60 mA
- Reverse voltage 3 V
- Peak forward current (1 μs pulse, 300 pps) 3.0 A
- Power dissipation 25°C ambient 60 mW
- Derate linearly from 25°C 2.6 mW/°C

OUTPUT TRANSISTOR

- Power dissipation @ 25°C 200 mW
- Derate linearly from 25°C 2.67 mW/°C

SWITCHING CHARACTERISTICS

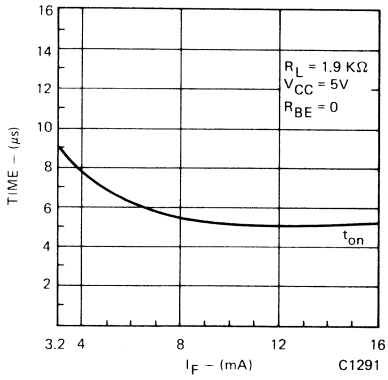


Fig. 9. Switch-on Time vs. I_F Drive (saturated)

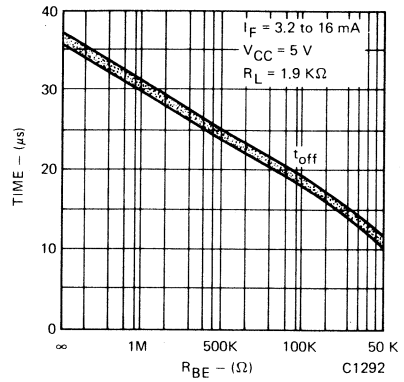


Fig. 10. Switch-off Time vs. Base to Emitter Resistance (saturated)

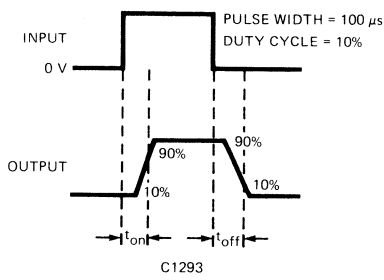


Fig. 11.

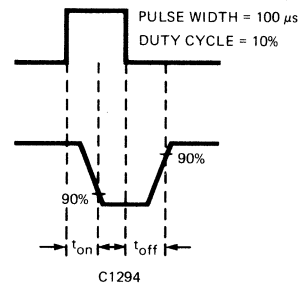


Fig. 12.

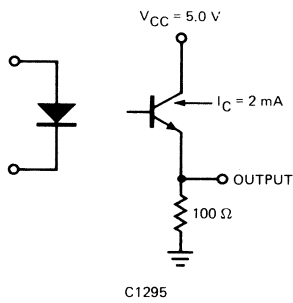


Fig. 13.

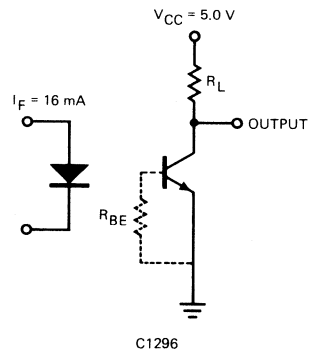


Fig. 14.

FEATURE SPECIFICATIONS

- **Controlled Current Transfer Ratio** – 75% to 150% (specified conditions)
- **Maximum Turn-on time** – 10 μ seconds (specified condition)
- **Maximum Turn-off time** – 10 μ seconds (specified condition)
- **Surge Isolation Rating** –
3550 volts DC 2500 volts AC, rms
- **Steady-state Isolation Rating** –
3150 volts DC 2250 volts AC, rms
- **Underwriters Laboratory (U.L.) recognized**
– File E50151

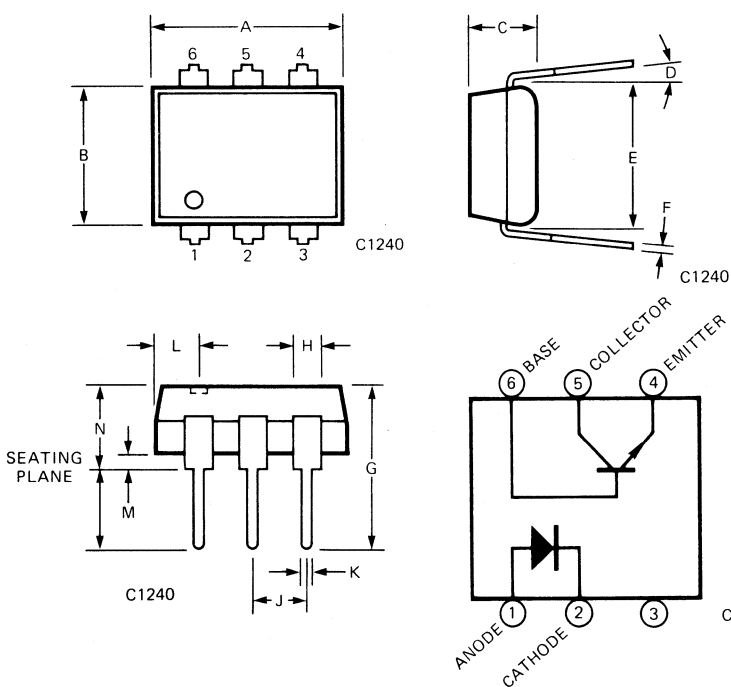
DESCRIPTION

The MCT272 is a phototransistor-type optically coupled isolator. An infrared emitting diode manufactured from specially grown gallium arsenide is selectively coupled with an NPN silicon phototransistor. The device is supplied in a standard plastic six-pin dual-in-line package.

APPLICATIONS

- Power supply regulators
- Digital logic inputs
- Microprocessor inputs
- Appliance sensor systems
- Power supply regulators
- Industrial controls

PACKAGE DIMENSIONS



SYMBOL	INCHES MAX.	mm MAX.	NOTES
A	.365	9.27	
B	.270	6.73	
C	.130	3.18	
D	15°	15°	
E	.300 Ref.	7.62 Ref.	1
F	.014	0.36	
G	.325	8.26	
H	.070	1.78	
J	.110	2.79	
K	.022	0.56	
L	.085	2.16	2
M			3
N	.175	4.45	4
P			3

- NOTES
1. INSTALLED POSITION OF LEAD CENTERS
 2. FOUR PLACES
 3. OVERALL INSTALLED POSITION
 4. THESE MEASUREMENTS ARE MADE FROM THE SEATING PLANE

ELECTRO-OPTICAL CHARACTERISTICS (0° to +70°C Temperature unless otherwise specified)

TRANSFER CHARACTERISTICS							
	CHARACTERISTIC	SYMBOL	MIN.	TYP.	MAX.	UNITS	TEST CONDITIONS
DC	Current Transfer Ratio, collector to emitter	I_{CE}/I_F	75	115	150	%	$I_F = 10 \text{ mA}; V_{CE} = 10 \text{ V}$
			12.5			%	$I_F = 16 \text{ mA}; V_{CE} = 0.4 \text{ V}$
	Current Transfer Ratio, collector to base	I_{CB}/I_F		.15		%	$I_F = 10 \text{ mA}; V_{CB} = 10 \text{ V}$
	Saturation voltage	$V_{CE(SAT)}$.12	.40	V	$I_F = 16 \text{ mA}; I_C = 2 \text{ mA}$
SWITCHING TIMES	Non-saturated Turn-on time	t_{on}		6.0	10	μs	$R_L = 100 \Omega; I_C = 2 \text{ mA}; V_{CC} = 5 \text{ V}$
	Turn-off time	t_{off}		5.5	10	μs	See figures 11, 13
	Saturated Turn-on time	t_{on}		3.9		μs	$I_F = 16 \text{ mA}; R_L = 1.9 \text{ K}\Omega$
	Turn-off time (Approximates a typical TTL interface)	t_{off}		48		μs	See figures 12, 14
	Turn-on time	t_{on}		3.9		μs	$I_F = 16 \text{ mA}; R_L = 4.7 \text{ K}\Omega$
	Turn-off time (Approximates a typical low power TTL interface)	t_{off}		110		μs	See figures 12, 14
ISOLATION	Surge isolation	V_{iso}	3550			VDC	Relative humidity $\leq 50\%$, $T_A = +25^\circ\text{C}, I_{I-O} \leq 10 \mu\text{A}$ 1 second
	Steady state isolation	V_{iso}	2500			VAC-rms	1 second
		V_{iso}	3150			VDC	Relative humidity $\leq 50\%$, $T_A = +25^\circ\text{C}, I_{I-O} \leq 10 \mu\text{A}$ 1 minute
	Isolation resistance	R_{iso}	2250			VAC-rms	1 minute
		R_{iso}	10^{11}			ohms	$V_{I-O} = 500 \text{ VDC}, T_A = +25^\circ\text{C}$
	Isolation capacitance	C_{iso}		.5		pF	$f = 1 \text{ MHz}$

INDIVIDUAL COMPONENT CHARACTERISTICS							
	CHARACTERISTIC	SYMBOL	MIN.	TYP.	MAX.	UNITS	TEST CONDITIONS
INPUT DIODE	Forward voltage	V_F		1.20	1.50	V	$I_F = 20 \text{ mA}$
	Forward voltage temp. coefficient			-1.8		mV/°C	
	Reverse breakdown voltage	BV_R	3.0	25		V	$I_R = 10 \mu\text{A}$
	Junction capacitance	C_J		50		pF	$V_F = 0 \text{ V}, f = 1 \text{ MHz}$
	Reverse leakage current	I_R		65	10	μA	$V_F = 1 \text{ V}, f = 1 \text{ MHz}$ $V_R = 3.0 \text{ V}$
OUTPUT TRANSISTOR	DC forward current gain	h_{FE}	100	500			$V_{CE} = 5 \text{ V}, I_C = 100 \mu\text{A}$
	Breakdown voltage						
	Collector to emitter	BV_{CEO}	30	45		V	$I_C = 1.0 \text{ mA}, I_F = 0$
	Collector to base	BV_{CBO}	70	130		V	$I_C = 10 \mu\text{A}$
	Emitter to collector	BV_{ECO}	7	10		V	$I_C = 100 \mu\text{A}, I_F = 0$
	Leakage current						
	Collector to emitter	I_{CEO}		5	50	nA	$V_{CE} = 10 \text{ V}, I_F = 0,$ $T_A = +25^\circ\text{C}$
	Capacitance						
Collector to emitter			8		pF	$V_{CE} = 0, f = 1 \text{ MHz}$	
Collector to base			20		pF	$V_{CB} = 5, f = 1 \text{ MHz}$	
Emitter to base			10		pF	$V_{EB} = 0, f = 1 \text{ MHz}$	

ALL TYP. READINGS @ +25°C

ELECTRICAL CHARACTERISTIC CURVES (25°C Free air temperature unless specified)

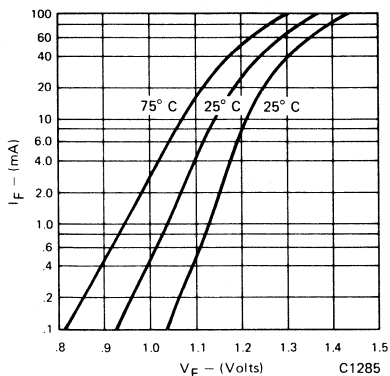


Fig. 1. Forward Voltage vs. Forward Current

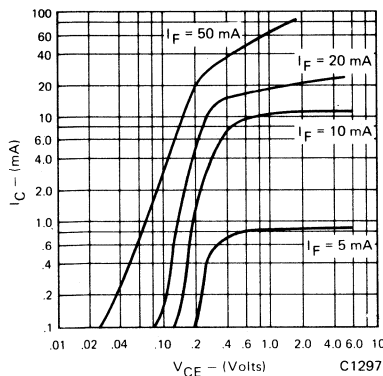


Fig. 2. Collector Current vs. Collector to Emitter Voltage

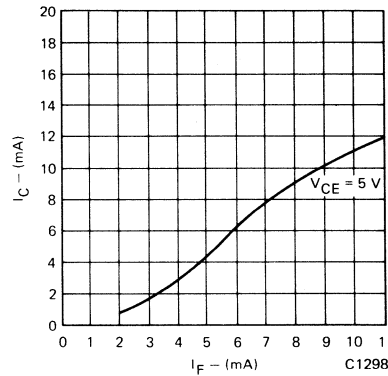


Fig. 3. Collector Current vs. Forward Current

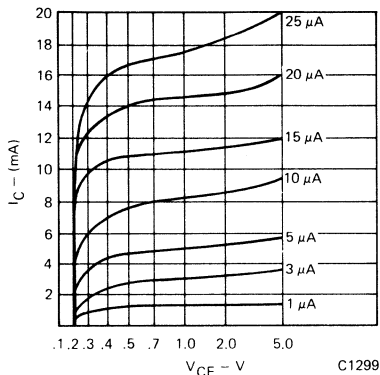


Fig. 4. Collector Current vs. Collector to Emitter Voltage

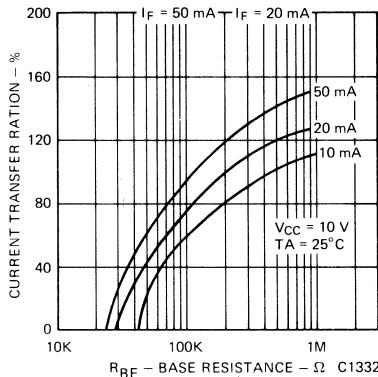


Fig. 5. Sensitivity vs. Base Resistance

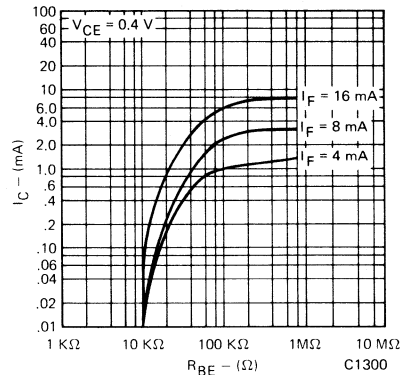


Fig. 6. Saturated CTR vs. Base to Emitter Resistance

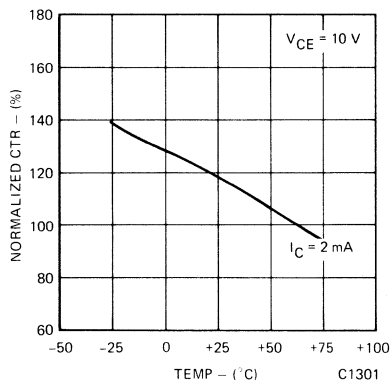


Fig. 7. Current Transfer Ratio (unsaturated) vs. Temperature

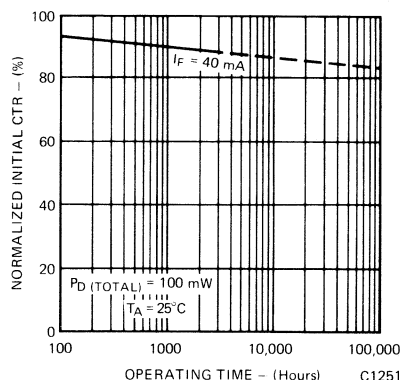


Fig. 8. Current Transfer Ratio vs. Operating Time

ABSOLUTE MAXIMUM RATINGS

TOTAL PACKAGE

- Storage temperature -55°C to 150°C
- Operating temperature -55°C to 100°C
- Lead temperature (Soldering, 10 sec) 260°C
- Total package power dissipation @ 25°C (LED plus detector) 260 mW
- Derate linearly from 25°C 3.4 mW/°C

INPUT DIODE

- Forward DC current 60 mA
- Reverse voltage 3 V
- Peak forward current (1 μs pulse, 300 pps) 3.0 A
- Power dissipation 25°C ambient 60 mW
- Derate linearly from 25°C 2.6 mW/°C

OUTPUT TRANSISTOR

- Power dissipation @ 25°C 200 mW
- Derate linearly from 25°C 2.67 mW/°C

SWITCHING CHARACTERISTICS

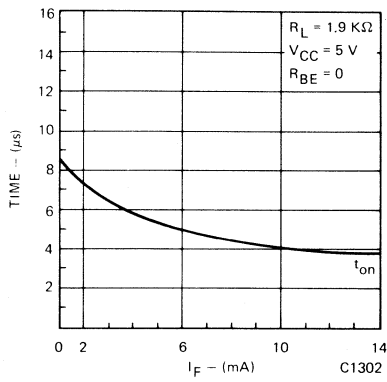


Fig. 9. Switch-on Time vs. I_F Drive (saturated)

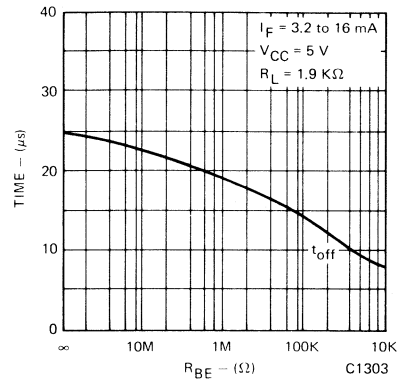


Fig. 10. Switch-off Time vs. Base to Emitter Resistance (saturated)

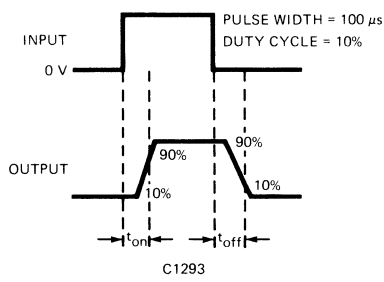


Fig. 11.

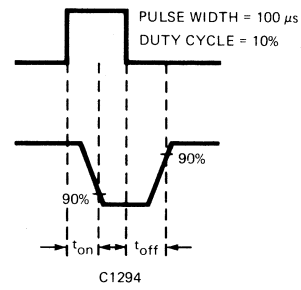


Fig. 12.

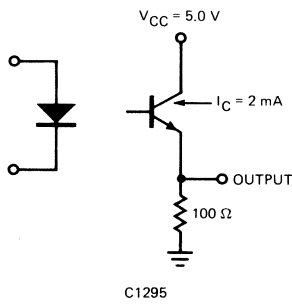


Fig. 13.

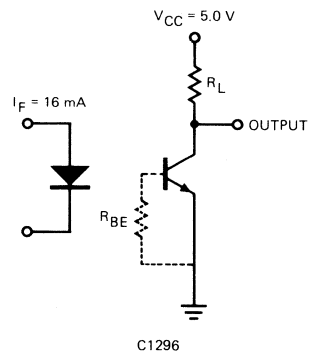


Fig. 14.

Monsanto

DESIGNER SERIES

MCT273

PHOTOTRANSISTOR OPTOISOLATORS

FEATURE SPECIFICATIONS

- **Controlled Current Transfer Ratio** – 125% to 250% (specified conditions)
- **Maximum Turn-on time** – 20 μ seconds (specified condition)
- **Maximum Turn-off time** – 20 μ seconds (specified condition)
- **Surge Isolation Rating** –
3550 volts DC 2500 volts AC, rms
- **Steady-state Isolation Rating** –
3150 volts DC 2250 volts AC, rms
- **Underwriters Laboratory (U.L.) recognized**
– File E50151

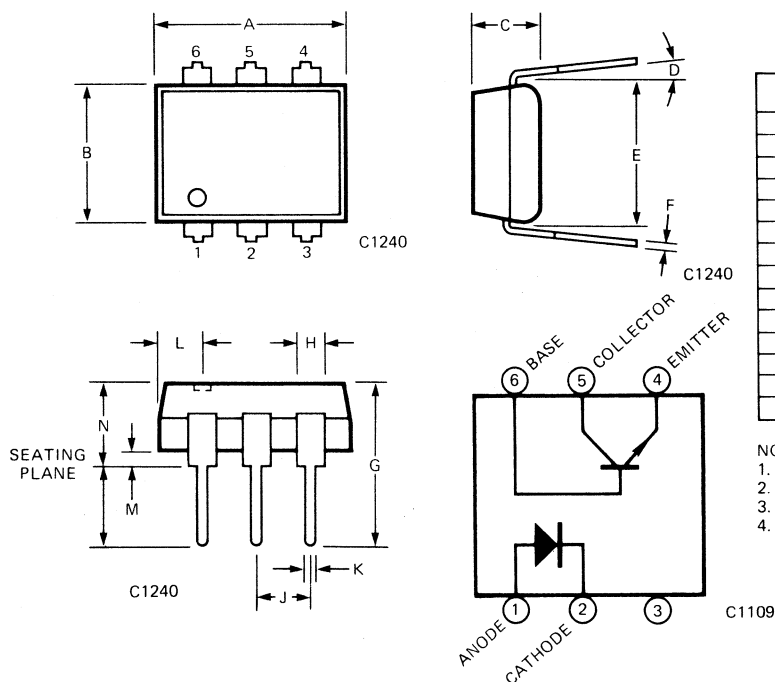
DESCRIPTION

The MCT273 is a phototransistor-type optically coupled isolator. An infrared emitting diode manufactured from specially grown gallium arsenide is selectively coupled with an NPN silicon phototransistor. The device is supplied in a standard plastic six-pin dual-in-line package.

APPLICATIONS

- Microprocessor board, reversible input/output
- Sensors to logic
- Logic to controls
- Appliance controls
- Industrial process control systems

PACKAGE DIMENSIONS



SYMBOL	INCHES MAX.	mm MAX.	NOTES
A	.365	9.27	
B	.270	6.73	
C	.130	3.18	
D	15°	15°	
E	.300 Ref.	7.62 Ref.	1
F	.014	0.36	
G	.325	8.26	
H	.070	1.78	
J	.110	2.79	
K	.022	0.56	
L	.085	2.16	2
M			3
N	.175	4.45	4
P			3

- NOTES
1. INSTALLED POSITION OF LEAD CENTERS
 2. FOUR PLACES
 3. OVERALL INSTALLED POSITION
 4. THESE MEASUREMENTS ARE MADE FROM THE SEATING PLANE

ELECTRO-OPTICAL CHARACTERISTICS (0° to +70°C Temperature unless otherwise specified)

		TRANSFER CHARACTERISTICS					
	CHARACTERISTIC	SYMBOL	MIN.	TYP.	MAX.	UNITS	TEST CONDITIONS
DC	Current Transfer Ratio, collector to emitter	I_{CE}/I_F	125 12.5	200	250	% %	$I_F = 10 \text{ mA}; V_{CE} = 10 \text{ V}$ $I_F = 16 \text{ mA}; V_{CE} = 0.4 \text{ V}$
	Current Transfer Ratio, collector to base	I_{CB}/I_F		.15		%	$I_F = 10 \text{ mA}; V_{CB} = 10 \text{ V}$
	Saturation voltage	$V_{CE(SAT)}$.20	.40	V	$I_F = 16 \text{ mA}; I_C = 2 \text{ mA}$
SWITCHING TIMES	Non-saturated Turn-on time	t_{on}		7.6	20	μs	$R_L = 100 \Omega; I_C = 2 \text{ mA};$ $V_{CC} = 5 \text{ V}$
	Turn-off time	t_{off}		6.6	20	μs	See figures 11, 13
	Saturated Turn-on time	t_{on}		3.6		μs	$I_F = 16 \text{ mA}; R_L = 1.9 \text{ K}\Omega$
	Turn-off time (Approximates a typical TTL interface)	t_{off}		75		μs	See figures 12, 14
	Turn-on time	t_{on}		3.6		μs	$I_F = 16 \text{ mA}; R_L = 4.7 \text{ K}\Omega$
	Turn-off time (Approximates a typical low power TTL interface)	t_{off}		1.55		μs	See figures 12, 14
ISOLATION	Surge isolation	V_{iso}	3550			VDC	Relative humidity $\leq 50\%$, $T_A = +25^\circ\text{C}, I_{I-O} \leq 10 \mu\text{A}$
	Steady state isolation	V_{iso}	2500 3150			VAC-rms VDC	1 second Relative humidity $\leq 50\%$, $T_A = +25^\circ\text{C}, I_{I-O} \leq 10 \mu\text{A}$
	Isolation resistance	R_{iso}	2250 10^{11}			VAC-rms ohms	1 minute $V_{I-O} = 500 \text{ VDC},$ $T_A = +25^\circ\text{C}$
	Isolation capacitance	C_{iso}		5		pF	$f = 1 \text{ MHz}$

		INDIVIDUAL COMPONENT CHARACTERISTICS					
	CHARACTERISTIC	SYMBOL	MIN.	TYP.	MAX.	UNITS	TEST CONDITIONS
INPUT DIODE	Forward voltage	V_F		1.20	1.50	V	$I_F = 20 \text{ mA}$
	Forward voltage temp. coefficient			-1.8		mV/°C	
	Reverse breakdown voltage	BV_R	3.0	25		V	$I_R = 10 \mu\text{A}$
	Junction capacitance	C_J		50		pF	$V_F = 0 \text{ V}, f = 1 \text{ MHz}$
	Reverse leakage current	I_R		65 .35	10	pF μA	$V_F = 1 \text{ V}, f = 1 \text{ MHz}$ $V_R = 3.0 \text{ V}$
OUTPUT TRANSISTOR	DC forward current gain	h_{FE}	100	280			$V_{CE} = 5 \text{ V}, I_C = 100 \mu\text{A}$
	Breakdown voltage						
	Collector to emitter	BV_{CEO}	30	70		V	$I_C = 1.0 \text{ mA}, I_F = 0$
	Collector to base	BV_{CBO}	70	170		V	$I_C = 10 \mu\text{A}$
	Emitter to collector	BV_{ECO}	7	12		V	$I_C = 100 \mu\text{A}, I_F = 0$
	Leakage current						
	Collector to emitter	I_{CEO}		5	50	nA	$V_{CE} = 10 \text{ V}, I_F = 0,$ $T_A = +25^\circ\text{C}$
Capacitance							
Collector to emitter			8		pF	$V_{CE} = 0, f = 1 \text{ MHz}$	
Collector to base			20		pF	$V_{CB} = 5, f = 1 \text{ MHz}$	
Emitter to base			10		pF	$V_{EB} = 0, f = 1 \text{ MHz}$	

ALL TYP. READINGS @ +25°C

ELECTRICAL CHARACTERISTIC CURVES (25°C Free air temperature unless specified)

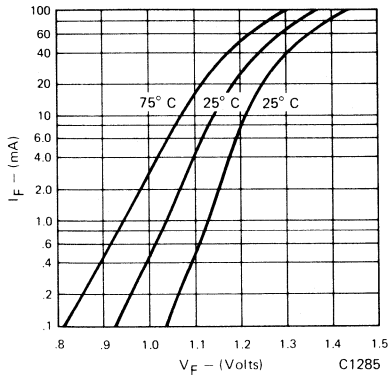


Fig. 1. Forward Voltage vs. Forward Current

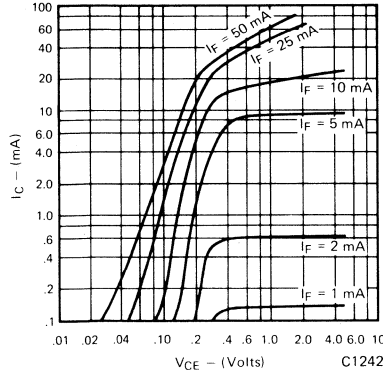


Fig. 2. Collector Current vs. Collector to Emitter Voltage

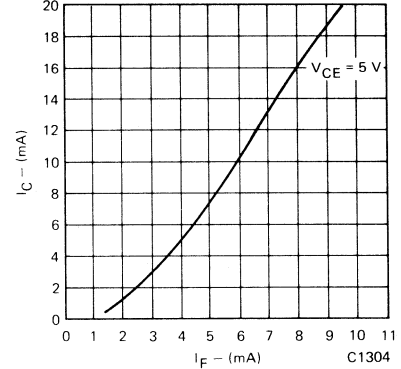


Fig. 3. Collector Current vs. Forward Current

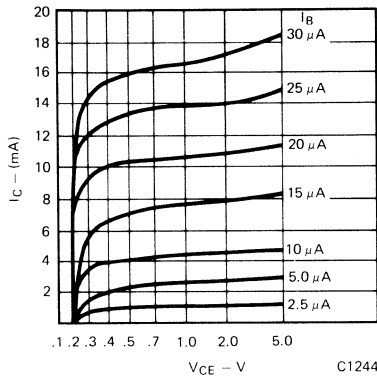


Fig. 4. Collector Current vs. Collector to Emitter Voltage

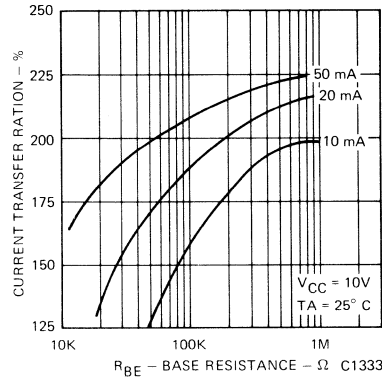


Fig. 5. Sensitivity vs. Base Resistance

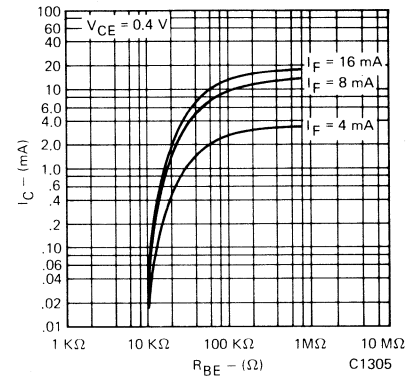


Fig. 6. Saturated CTR vs. Base to Emitter Resistance

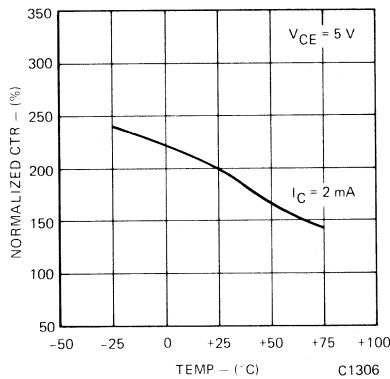


Fig. 7. Current Transfer Ratio (unsaturated) vs. Temperature

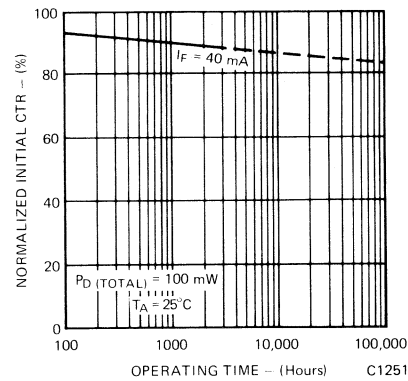


Fig. 8. Current Transfer Ratio vs. Operating Time

ABSOLUTE MAXIMUM RATINGS

TOTAL PACKAGE

Storage temperature	-55°C to 150°C
Operating temperature	-55°C to 100°C
Lead temperature (Soldering, 10 sec)	260°C
Total package power dissipation @ 25°C (LED plus detector)	260 mW
Derate linearly from 25°C	3.4 mW/°C

INPUT DIODE

Forward DC current	60 mA
Reverse voltage	3 V
Peak forward current (1 μs pulse, 300 pps)	3.0 A
Power dissipation 25°C ambient	60 mW
Derate linearly from 25°C	2.6 mW/°C

OUTPUT TRANSISTOR

Power dissipation @ 25°C	200 mW
Derate linearly from 25°C	2.67 mW/°C

SWITCHING CHARACTERISTICS

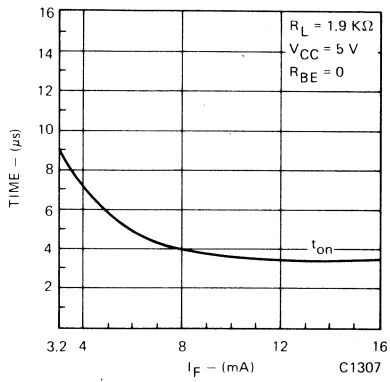


Fig. 9. Switch-on Time vs. I_F Drive (saturated)

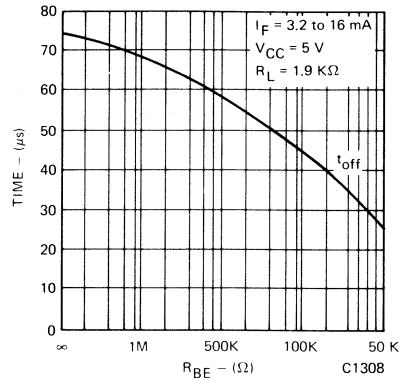


Fig. 10. Switch-off Time vs. Base to Emitter Resistance (saturated)

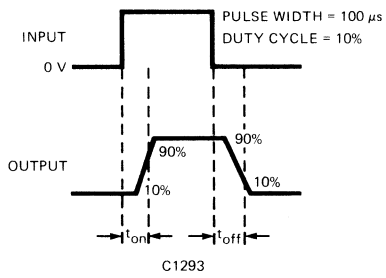


Fig. 11.

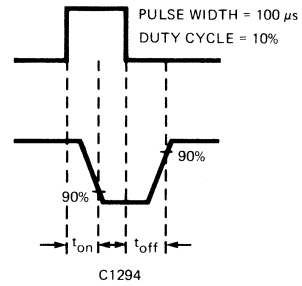


Fig. 12.

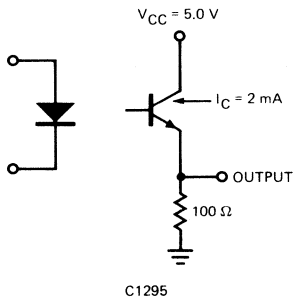


Fig. 13.

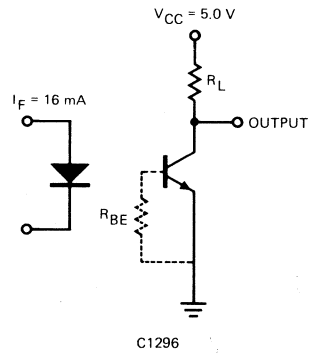


Fig. 14.

Monsanto

DESIGNER SERIES

MCT274

PHOTOTRANSISTOR OPTOISOLATORS

FEATURE SPECIFICATIONS

- **Controlled Current Transfer Ratio** — 225% to 400% (specified conditions)
- **Maximum Turn-on time** — 25 μ seconds (specified condition)
- **Maximum Turn-off time** — 25 μ seconds (specified condition)
- **Surge Isolation Rating** —
3550 volts DC 2500 volts AC, rms
- **Steady-state Isolation Rating** —
3150 volts DC 2250 volts AC, rms
- **Underwriters Laboratory (U.L.) recognized**
— File E50151

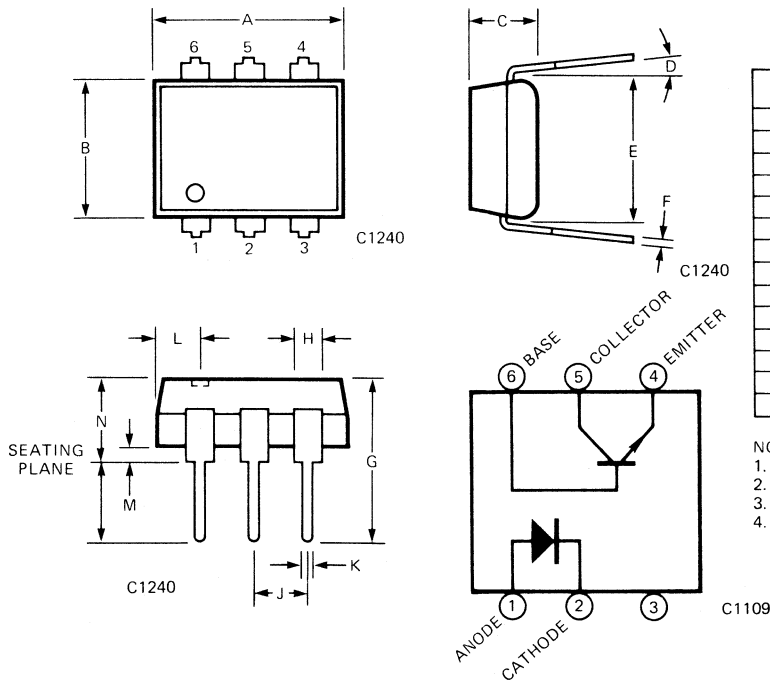
DESCRIPTION

The MCT274 is a phototransistor-type optically coupled isolator. An infrared emitting diode manufactured from specially grown gallium arsenide is selectively coupled with an NPN high-gain silicon phototransistor. The device is supplied in a standard plastic six-pin dual-in-line package.

APPLICATIONS

- Control Relays
- Digital controls
- Microprocessor controls
- Replace slow photodarlington types with better switching speeds and equivalent gain devices
- Multiple gate interface

PACKAGE DIMENSIONS



SYMBOL	INCHES MAX.	mm MAX.	NOTES
A	.365	9.27	
B	.270	6.73	
C	.130	3.18	
D	15°	15°	
E	.300 Ref.	7.62 Ref.	1
F	.014	0.36	
G	.325	8.26	
H	.070	1.78	
J	.110	2.79	
K	.022	0.56	
L	.085	2.16	2
M			3
N	.175	4.45	4
P			3

NOTES

1. INSTALLED POSITION OF LEAD CENTERS
2. FOUR PLACES
3. OVERALL INSTALLED POSITION
4. THESE MEASUREMENTS ARE MADE FROM THE SEATING PLANE

ELECTRO-OPTICAL CHARACTERISTICS (0° to +70°C Temperature unless otherwise specified)

TRANSFER CHARACTERISTICS							
	CHARACTERISTIC	SYMBOL	MIN.	TYP.	MAX.	UNITS	TEST CONDITIONS
DC	Current Transfer Ratio, collector to emitter	I_{CE}/I_F	225 12.5	305	400	% %	$I_F = 10 \text{ mA}; V_{CE} = 10 \text{ V}$ $I_F = 16 \text{ mA}; V_{CE} = 0.4 \text{ V}$
	Current Transfer Ratio, collector to base	I_{CB}/I_F		.15		%	$I_F = 10 \text{ mA}; V_{CB} = 10 \text{ V}$
	Saturation voltage	$V_{CE(SAT)}$.16	.40	V	$I_F = 16 \text{ mA}; I_C = 2 \text{ mA}$
SWITCHING TIMES	Non-saturated Turn-on time	t_{on}		9.1	25	μs	$R_L = 100 \Omega; I_C = 2 \text{ mA};$ $V_{CC} = 5 \text{ V}$
	Turn-off time	t_{off}		7.9	25	μs	See figures 11, 13
	Saturated Turn-on time	t_{on}		3.0		μs	$I_F = 16 \text{ mA}; R_L = 1.9 \text{ K}\Omega$
	Turn-off time (Approximates a typical TTL interface)	t_{off}		95		μs	See figures 12, 14
	Turn-on time	t_{on}		3.0		μs	$I_F = 16 \text{ mA}; R_L = 4.7 \text{ K}\Omega$
	Turn-off time (Approximates a typical low power TTL interface)	t_{off}		185		μs	See figures 12, 14
ISOLATION	Surge isolation	V_{iso}	3550			VDC	Relative humidity $\leq 50\%$, $T_A = +25^\circ\text{C}, I_{I-O} \leq 10 \mu\text{A}$
	Steady state isolation	V_{iso}	2500			VAC-rms	1 second
			3150			VDC	Relative humidity $\leq 50\%$, $T_A = +25^\circ\text{C}, I_{I-O} \leq 10 \mu\text{A}$
	Isolation resistance	R_{iso}	2250 10^{11}				VAC-rms ohms
Isolation capacitance	C_{iso}		.5			pF	$f = 1 \text{ MHz}$

INDIVIDUAL COMPONENT CHARACTERISTICS							
	CHARACTERISTIC	SYMBOL	MIN.	TYP.	MAX.	UNITS	TEST CONDITIONS
INPUT DIODE	Forward voltage	V_F		1.20	1.50	V	$I_F = 20 \text{ mA}$
	Forward voltage temp. coefficient			-1.8		mV/°C	
	Reverse breakdown voltage	BV_R	3.0	25		V	$I_R = 10 \mu\text{A}$
	Junction capacitance	C_J		50		pF	$V_F = 0 \text{ V}, f = 1 \text{ MHz}$
	Reverse leakage current	I_R		65	10	μA	$V_F = 1 \text{ V}, f = 1 \text{ MHz}$ $V_R = 3.0 \text{ V}$
OUTPUT TRANSISTOR	DC forward current gain	h_{FE}	100	360			$V_{CE} = 5 \text{ V}, I_C = 100 \mu\text{A}$
	Breakdown voltage						
	Collector to emitter	BV_{CEO}	30	70		V	$I_C = 1.0 \text{ mA}, I_F = 0$
	Collector to base	BV_{CBO}	70	170		V	$I_C = 10 \mu\text{A}$
	Emitter to collector	BV_{ECO}	7	12		V	$I_C = 100 \mu\text{A}, I_F = 0$
	Leakage current						
	Collector to emitter	I_{CEO}		5	50	nA	$V_{CE} = 10 \text{ V}, I_F = 0,$ $T_A = +25^\circ\text{C}$
	Capacitance						
Collector to emitter			8		pF	$V_{CE} = 0, f = 1 \text{ MHz}$	
Collector to base			20		pF	$V_{CB} = 5, f = 1 \text{ MHz}$	
Emitter to base			10		pF	$V_{EB} = 0, f = 1 \text{ MHz}$	

ALL TYP. READINGS @ +25°C

ELECTRICAL CHARACTERISTIC CURVES (25°C Free air temperature unless specified)

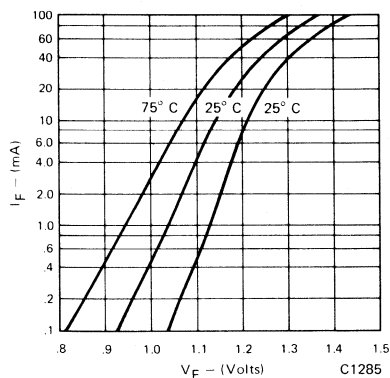


Fig. 1. Forward Voltage vs. Forward Current

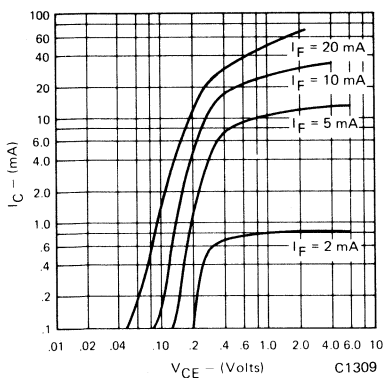


Fig. 2. Collector Current vs. Collector to Emitter Voltage

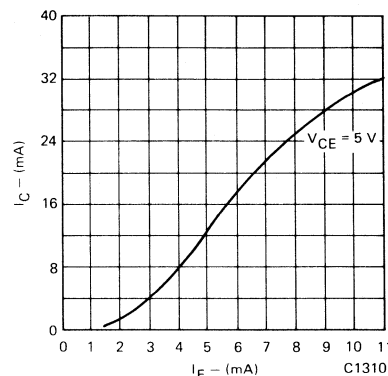


Fig. 3. Collector Current vs. Forward Current

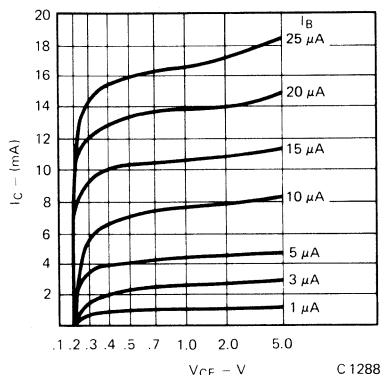


Fig. 4. Collector Current vs. Collector to Emitter Voltage

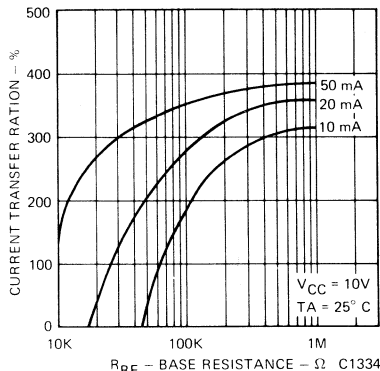


Fig. 5. Sensitivity vs. Base Resistance

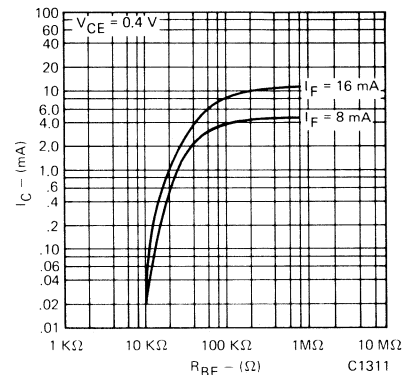


Fig. 6. Saturated CTR vs. Base to Emitter Resistance

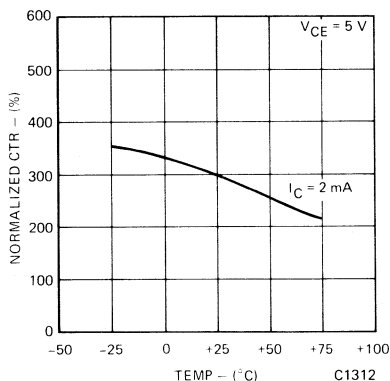


Fig. 7. Current Transfer Ratio (unsaturated) vs. Temperature

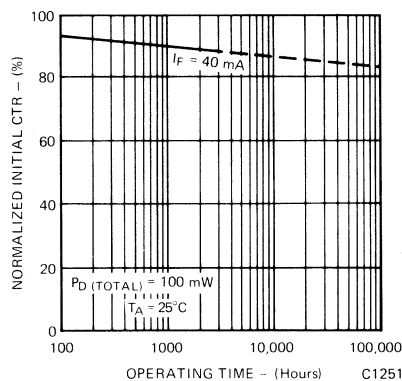


Fig. 8. Current Transfer Ratio vs. Operating Time

ABSOLUTE MAXIMUM RATINGS

TOTAL PACKAGE

Storage temperature	-55°C to 150°C
Operating temperature	-55°C to 100°C
Lead temperature (Soldering, 10 sec)	260°C
Total package power dissipation @ 25°C (LED plus detector)	260 mW
Derate linearly from 25°C	3.4 mW/°C

INPUT DIODE

Forward DC current	60 mA
Reverse voltage	3 V
Peak forward current (1 μs pulse, 300 pps)	3.0 A
Power dissipation 25°C ambient	200 mW
Derate linearly from 25°C	2.6 mW/°C

OUTPUT TRANSISTOR

Power dissipation @ 25°C	200 mW
Derate linearly from 25°C	2.67 mW/°C

SWITCHING CHARACTERISTICS

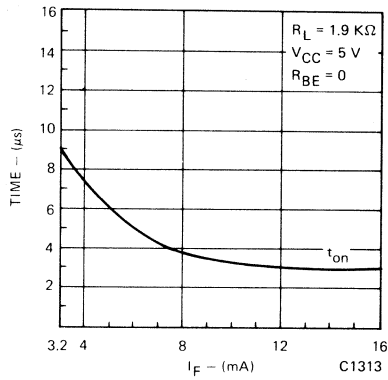


Fig. 9. Switch-on Time vs. I_F Drive (saturated)

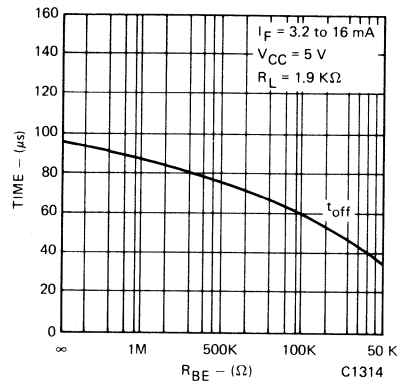


Fig. 10. Switch-off Time vs. Base to Emitter Resistance (saturated)

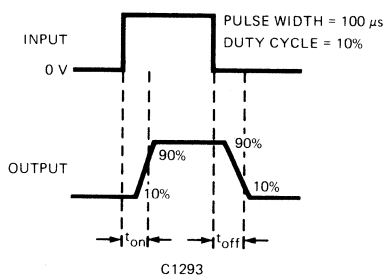


Fig. 11.

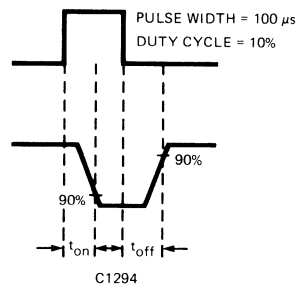


Fig. 12.

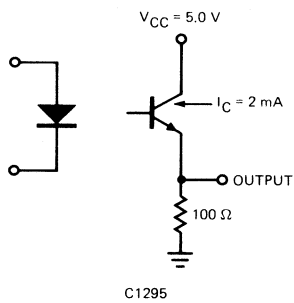


Fig. 13.

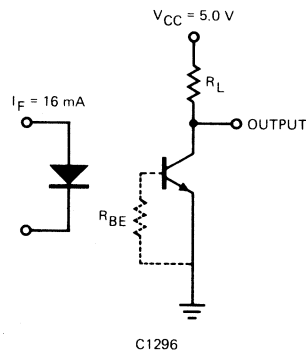


Fig. 14.

Monsanto

DESIGNER SERIES

MCT275

PHOTOTRANSISTOR OPTOISOLATORS

FEATURE SPECIFICATIONS

- High voltage output — 80 volts, BV_{CEO}
- Controlled Current Transfer Ratio — 70% to 210% (specified conditions)
- Maximum Turn-on time — 15 μ seconds (specified condition)
- Maximum Turn-off time — 15 μ seconds (specified condition)
- Surge Isolation Rating —
3550 volts DC 2500 volts AC, rms
- Steady-state Isolation Rating —
3150 volts DC 2250 volts AC, rms
- Underwriters Laboratory (U.L.) recognized
— File E50151

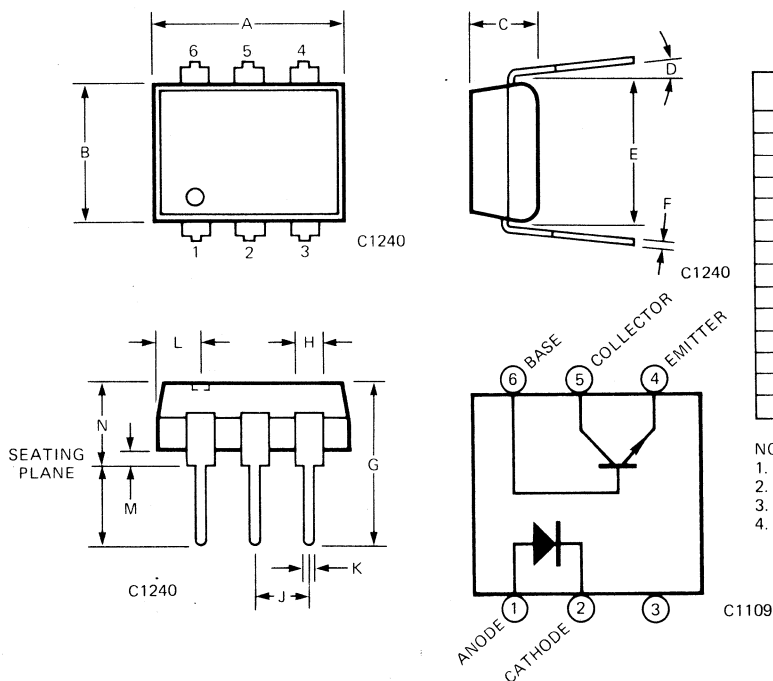
DESCRIPTION

The MCT275 is a phototransistor-type optically coupled isolator. An infrared emitting diode manufactured from specially grown gallium arsenide is selectively coupled with a high voltage NPN silicon phototransistor. The device is supplied in a standard plastic six-pin dual-in-line package.

APPLICATIONS

- Telephone circuits
- Digital input to telecommunications
- Industrial control of high DC voltage
- Telephone relay driver

PACKAGE DIMENSIONS



SYMBOL	INCHES MAX.	mm MAX.	NOTES
A	.365	9.27	
B	.270	6.73	
C	.130	3.18	
D	15°	15°	
E	.300 Ref.	7.62 Ref.	1
F	.014	0.36	
G	.325	8.26	
H	.070	1.78	
J	.110	2.79	
K	.022	0.56	
L	.085	2.16	2
M			3
N	.175	4.45	4
P			3

NOTES

1. INSTALLED POSITION OF LEAD CENTERS
2. FOUR PLACES
3. OVERALL INSTALLED POSITION
4. THESE MEASUREMENTS ARE MADE FROM THE SEATING PLANE

ELECTRO-OPTICAL CHARACTERISTICS (0° to +70°C Temperature unless otherwise specified)

TRANSFER CHARACTERISTICS							
	CHARACTERISTIC	SYMBOL	MIN.	TYP.	MAX.	UNITS	TEST CONDITIONS
DC	Current Transfer Ratio, collector to emitter	I_{CE}/I_F	70	125	210	%	$I_F = 10 \text{ mA}; V_{CE} = 10 \text{ V}$
			12.5			%	$I_F = 16 \text{ mA}; V_{CE} = 0.4 \text{ V}$
	Current Transfer Ratio, collector to base	I_{CB}/I_F		.15		%	$I_F = 10 \text{ mA}; V_{CB} = 10 \text{ V}$
	Saturation voltage		$V_{CE(SAT)}$.25	.40	V
SWITCHING TIMES	Non-saturated Turn-on time	t_{on}		4.5	7	μs	$R_L = 100 \Omega; I_C = 2 \text{ mA}; V_{CC} = 5 \text{ V}$
	Turn-off time		t_{off}		3.5	7	μs
	Saturated Turn-on time	t_{on}		3.2		μs	$I_F = 16 \text{ mA}; R_L = 1.9 \text{ K}\Omega$
	Turn-off time (Approximates a typical TTL interface)		t_{off}		50		μs
	Turn-on time (Approximates a typical low power TTL interface)	t_{on}		3.1		μs	$I_F = 16 \text{ mA}; R_L = 4.7 \text{ K}\Omega$
	Turn-off time (Approximates a typical low power TTL interface)		t_{off}		90		μs
ISOLATION	Surge isolation	V_{iso}	3550			VDC	Relative humidity $\leq 50\%$, $T_A = +25^\circ\text{C}$, $I_{I-O} \leq 10 \mu\text{A}$
	Steady state isolation		2500			VAC-rms	1 second
		V_{iso}	3150			VDC	Relative humidity $\leq 50\%$, $T_A = +25^\circ\text{C}$, $I_{I-O} \leq 10 \mu\text{A}$
	Isolation resistance	R_{iso}	2250			VAC-rms	1 minute
	Isolation capacitance	C_{iso}	10^{11}			ohms	$V_{I-O} = 500 \text{ VDC}$, $T_A = +25^\circ\text{C}$
				.5		pF	$f = 1 \text{ MHz}$

INDIVIDUAL COMPONENT CHARACTERISTICS							
	CHARACTERISTIC	SYMBOL	MIN.	TYP.	MAX.	UNITS	TEST CONDITIONS
INPUT DIODE	Forward voltage	V_F		1.20	1.50	V	$I_F = 20 \text{ mA}$
	Forward voltage temp. coefficient			-1.8		mV/°C	
	Reverse breakdown voltage	BV_R	3.0	25		V	$I_R = 10 \mu\text{A}$
	Junction capacitance	C_J		50		pF	$V_F = 0 \text{ V}, f = 1 \text{ MHz}$
	Reverse leakage current		I_R		.35	10	μA
OUTPUT TRANSISTOR	DC forward current gain	h_{FE}	100	170			$V_{CE} = 5 \text{ V}, I_C = 100 \mu\text{A}$
	Breakdown voltage						
	Collector to emitter	BV_{CEO}	80	85		V	$I_C = 1.0 \text{ mA}, I_F = 0$
	Collector to base	BV_{CBO}	70	180		V	$I_C = 10 \mu\text{A}$
	Emitter to collector	BV_{ECO}	7	11		V	$I_C = 100 \mu\text{A}, I_F = 0$
	Leakage current	I_{CEO}		5	50	nA	$V_{CE} = 10 \text{ V}, I_F = 0$, $T_A = +25^\circ\text{C}$
	Collector to emitter						
Capacitance							
Collector to emitter				8		pF	$V_{CE} = 0, f = 1 \text{ MHz}$
Collector to base				20		pF	$V_{CB} = 5, f = 1 \text{ MHz}$
Emitter to base				10		pF	$V_{EB} = 0, f = 1 \text{ MHz}$

ALL TYP. READINGS @ +25°C

ELECTRICAL CHARACTERISTIC CURVES (25°C Free air temperature unless specified)

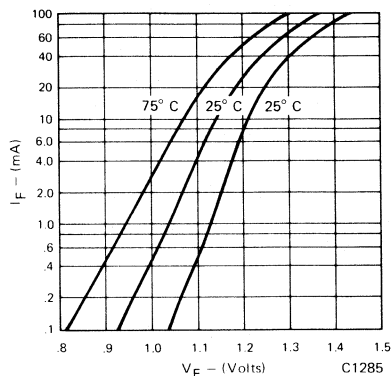


Fig. 1. Forward Voltage vs. Forward Current

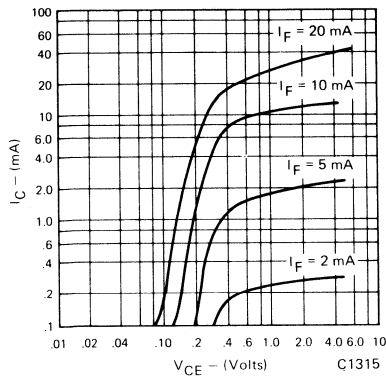


Fig. 2. Collector Current vs. Collector to Emitter Voltage

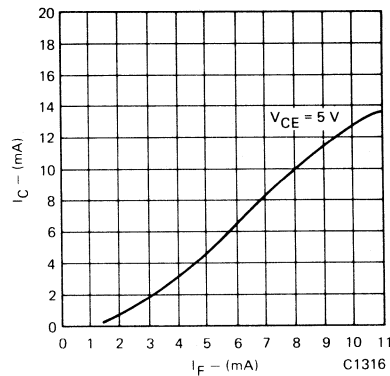


Fig. 3. Collector Current vs. Forward Current

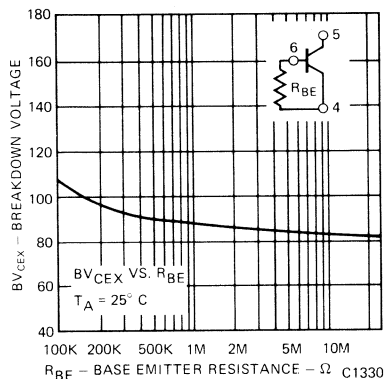


Fig. 4. Collector-Emitter Breakdown Voltage vs. Base Resistance

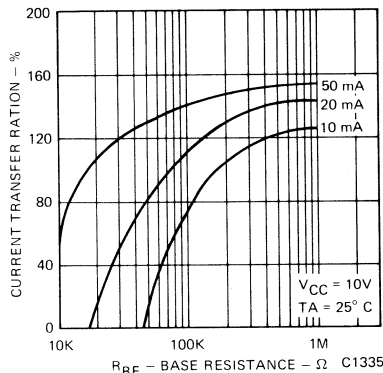


Fig. 5. Sensitivity vs. Base Resistance

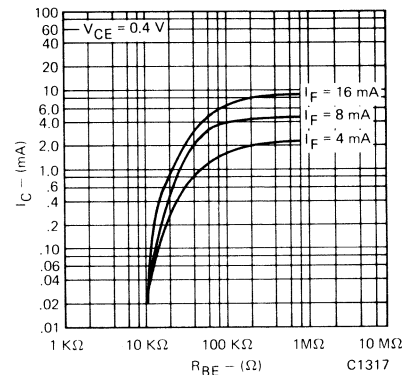


Fig. 6. Saturated CTR vs. Base to Emitter Resistance

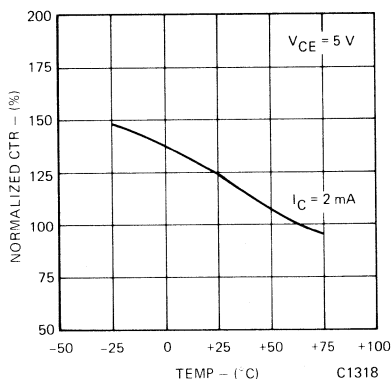


Fig. 7. Current Transfer Ratio (unsaturated) vs. Temperature

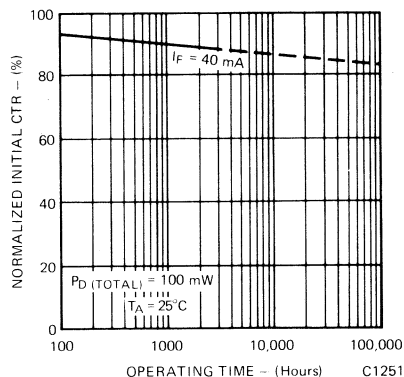


Fig. 8. Current Transfer Ratio vs. Operating Time

ABSOLUTE MAXIMUM RATINGS

TOTAL PACKAGE

Storage temperature	-55°C to 150°C
Operating temperature	-55°C to 100°C
Lead temperature	
(Soldering, 10 sec)	260°C
Total package power dissipation @ 25°C	
(LED plus detector)	260 mW
Derate linearly from 25°C	3.4 mW/°C

INPUT DIODE

Forward DC current	60 mA
Reverse voltage	3 V
Peak forward current	
(1 μs pulse, 300 pps)	3.0 A
Power dissipation 25°C ambient	200 mW
Derate linearly from 25°C	2.6 mW/°C

OUTPUT TRANSISTOR

Power dissipation @ 25°C	200 mW
Derate linearly from 25°C	2.67 mW/°C

SWITCHING CHARACTERISTICS

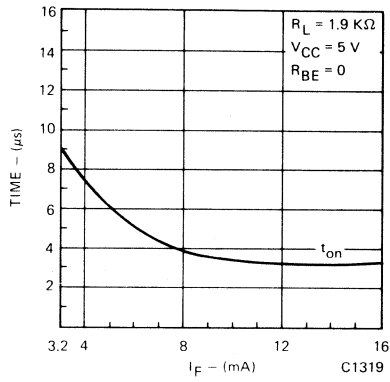


Fig. 9. Switch-on Time vs. I_F Drive (saturated)

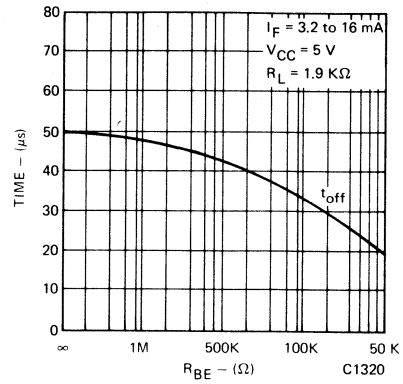


Fig. 10. Switch-off Time vs. Base to Emitter Resistance (saturated)

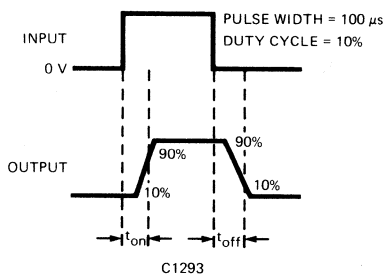


Fig. 11.

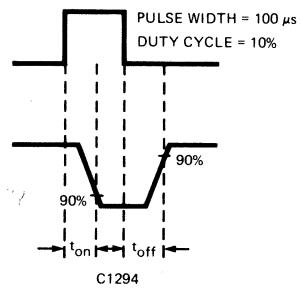


Fig. 12.

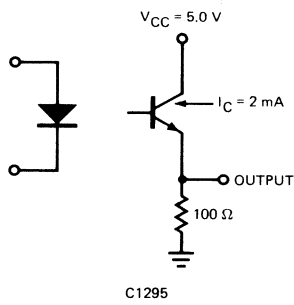


Fig. 13.

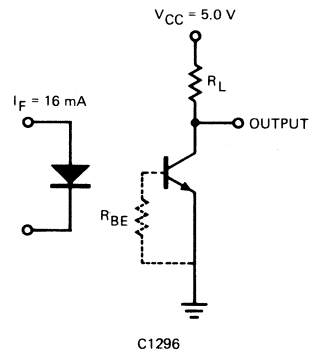


Fig. 14.

Monsanto

DESIGNER SERIES

MCT276

PHOTOTRANSISTOR OPTOISOLATORS

FEATURE SPECIFICATIONS

- Highest speed discrete phototransistor optoisolator
- Controlled Current Transfer Ratio — 15% to 60% (specified conditions)
- Maximum Turn-on time — 2.5 μ seconds (specified condition)
- Maximum Turn-off time — 2.5 μ seconds (specified condition)
- Surge Isolation Rating —
3550 volts DC 2500 volts AC, rms
- Steady-state Isolation Rating —
3150 volts DC 2250 volts AC, rms
- Underwriters Laboratory (U.L.) recognized — File E50151

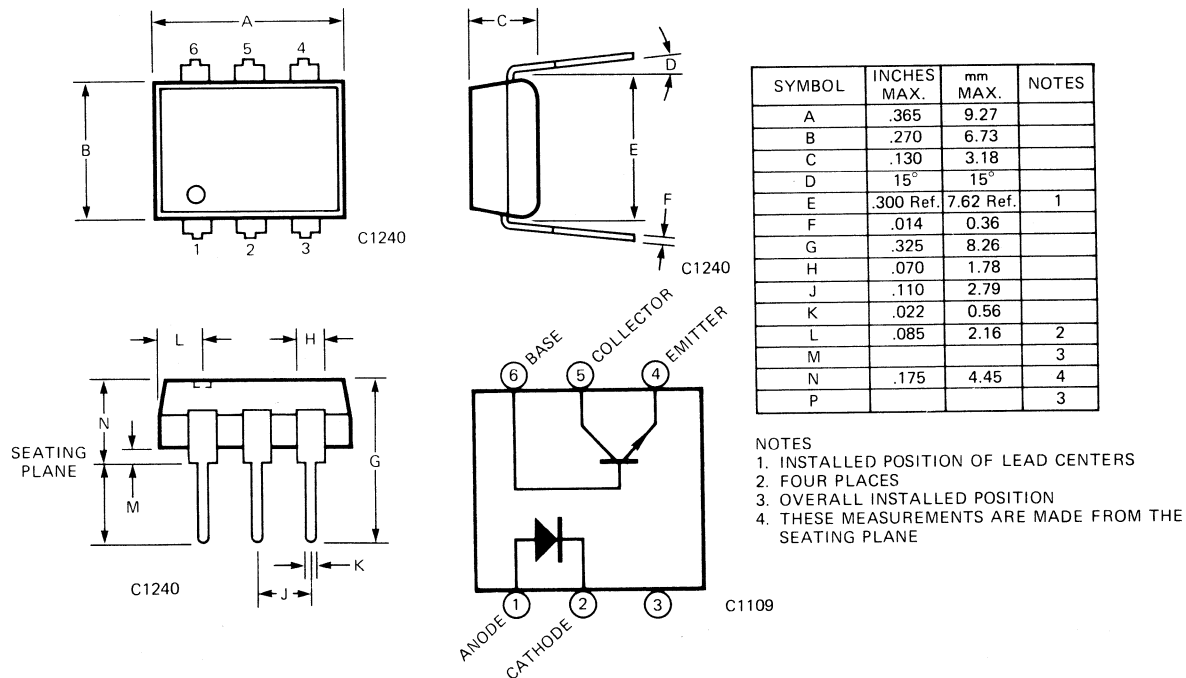
DESCRIPTION

The MCT276 is a phototransistor-type optically coupled isolator. An infrared emitting diode manufactured from specially grown gallium arsenide is selectively coupled with a high speed NPN silicon phototransistor. The device is supplied in a standard plastic six-pin dual-in-line package.

APPLICATIONS

- Data communications
- Digital ground isolation
- Digital logic inputs
- Microprocessor inputs
- Appliance sensor systems

PACKAGE DIMENSIONS



ELECTRO-OPTICAL CHARACTERISTICS (0° to +70°C Temperature unless otherwise specified)

TRANSFER CHARACTERISTICS							
	CHARACTERISTIC	SYMBOL	MIN.	TYP.	MAX.	UNITS	TEST CONDITIONS
DC	Current Transfer Ratio, collector to emitter	I_{CE}/I_F	15	30	60	%	$I_F = 10 \text{ mA}; V_{CE} = 10 \text{ V}$
			12.5			%	$I_F = 16 \text{ mA}; V_{CE} = 0.4 \text{ V}$
	Current Transfer Ratio, collector to base	I_{CB}/I_F		.15		%	$I_F = 10 \text{ mA}; V_{CB} = 10 \text{ V}$
	Saturation voltage	$V_{CE(SAT)}$.24	.40	V	$I_F = 16 \text{ mA}; I_C = 2 \text{ mA}$
SWITCHING TIMES	Non-saturated Turn-on time	t_{on}		2.4	2.5	μs	$R_L = 100 \Omega; I_C = 2 \text{ mA}; V_{CC} = 5 \text{ V}$
	Turn-off time	t_{off}		2.2	2.5	μs	See figures 11, 13
	Saturated Turn-on time	t_{on}		6.8		μs	$I_F = 16 \text{ mA}; R_L = 1.9 \text{ K}\Omega$
	Turn-off time (Approximates a typical TTL interface)	t_{off}		16		μs	See figures 12, 14
	Turn-on time	t_{on}		5.4		μs	$I_F = 16 \text{ mA}; R_L = 4.7 \text{ K}\Omega$
	Turn-off time (Approximates a typical low power TTL interface)	t_{off}		32		μs	See figures 12, 14
ISOLATION	Surge isolation	V_{iso}	3550			VDC	Relative humidity $\leq 50\%$, $T_A = +25^\circ\text{C}, I_{I-O} \leq 10 \mu\text{A}$ 1 second
	Steady state isolation	V_{iso}	2500			VAC-rms	1 second
			3150			VDC	Relative humidity $\leq 50\%$, $T_A = +25^\circ\text{C}, I_{I-O} \leq 10 \mu\text{A}$ 1 minute
	Isolation resistance	R_{iso}	2250			VAC-rms	1 minute
			10^{11}			ohms	$V_{I-O} = 500 \text{ VDC}, T_A = +25^\circ\text{C}$
	Isolation capacitance	C_{iso}		.5		pF	$f = 1 \text{ MHz}$

INDIVIDUAL COMPONENT CHARACTERISTICS							
	CHARACTERISTIC	SYMBOL	MIN.	TYP.	MAX.	UNITS	TEST CONDITIONS
INPUT DIODE	Forward voltage	V_F		1.20	1.50	V	$I_F = 20 \text{ mA}$
	Forward voltage temp. coefficient			-1.8		mV/°C	
	Reverse breakdown voltage	BV_R	3.0	25		V	$I_R = 10 \mu\text{A}$
	Junction capacitance	C_J		50		pF	$V_F = 0 \text{ V}, f = 1 \text{ MHz}$
	Reverse leakage current	I_R		65	10	μA	$V_F = 1 \text{ V}, f = 1 \text{ MHz}$ $V_R = 3.0 \text{ V}$
OUTPUT TRANSISTOR	DC forward current gain	h_{FE}		90			$V_{CE} = 5 \text{ V}, I_C = 100 \mu\text{A}$
	Breakdown voltage						
	Collector to emitter	BV_{CEO}	30	45		V	$I_C = 1.0 \text{ mA}, I_F = 0$
	Collector to base	BV_{CBO}	70	130		V	$I_C = 10 \mu\text{A}$
	Emitter to collector	BV_{ECO}	7	10		V	$I_C = 100 \mu\text{A}, I_F = 0$
	Leakage current						
	Collector to emitter	I_{CEO}		5	50	nA	$V_{CE} = 10 \text{ V}, I_F = 0,$ $T_A = +25^\circ\text{C}$
	Capacitance						
Collector to emitter			8		pF	$V_{CE} = 0, f = 1 \text{ MHz}$	
Collector to base			20		pF	$V_{CB} = 5, f = 1 \text{ MHz}$	
Emitter to base			10		pF	$V_{EB} = 0, f = 1 \text{ MHz}$	

ALL TYP. READINGS @ +25°C

ELECTRICAL CHARACTERISTIC CURVES (25°C Free air temperature unless specified)

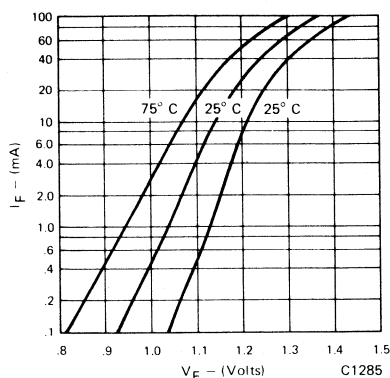


Fig. 1. Forward Voltage vs. Forward Current

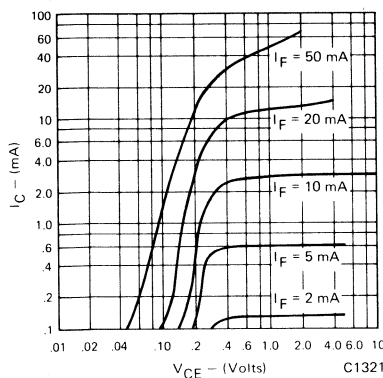


Fig. 2. Collector Current vs. Collector to Emitter Voltage

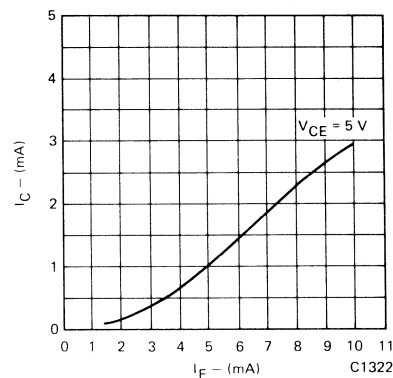


Fig. 3. Collector Current vs. Forward Current

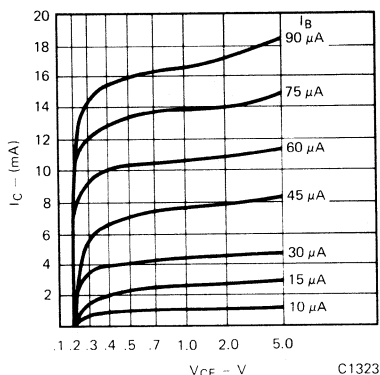


Fig. 4. Collector Current vs. Collector to Emitter Voltage

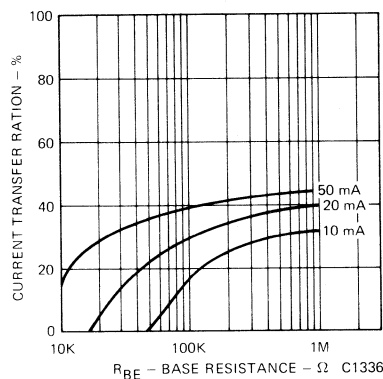


Fig. 5. Sensitivity vs. Base Resistance

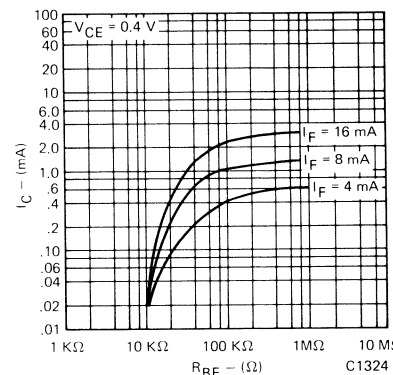


Fig. 6. Saturated CTR vs. Base to Emitter Resistance

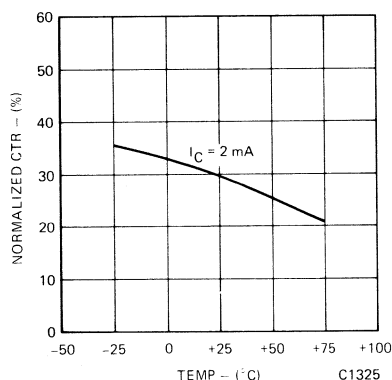


Fig. 7. Current Transfer Ratio (unsaturated) vs. Temperature

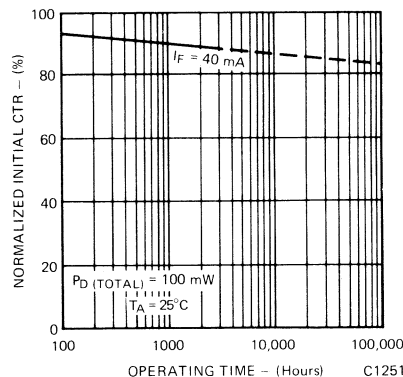


Fig. 8. Current Transfer Ratio vs. Operating Time

ABSOLUTE MAXIMUM RATINGS

TOTAL PACKAGE

Storage temperature	-55°C to 150°C
Operating temperature	-55°C to 100°C
Lead temperature	
(Soldering, 10 sec)	260°C
Total package power dissipation @ 25°C	
(LED plus detector)	260 mW
Derate linearly from 25°C	3.4 mW/°C

INPUT DIODE

Forward DC current	60 mA
Reverse voltage	3 V
Peak forward current	
(1 μs pulse, 300 pps)	3.0 A
Power dissipation 25°C ambient	200 mW
Derate linearly from 25°C	2.6 mW/°C

OUTPUT TRANSISTOR

Power dissipation @ 25°C	200 mW
Derate linearly from 25°C	2.67 mW/°C

SWITCHING CHARACTERISTICS

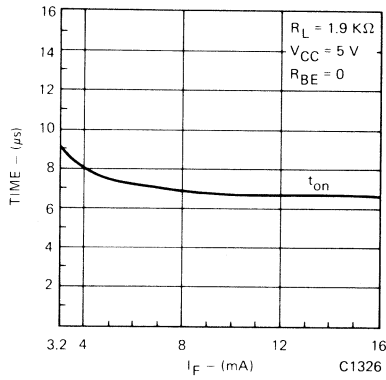


Fig. 9. Switch-on Time vs. I_F Drive (saturated)

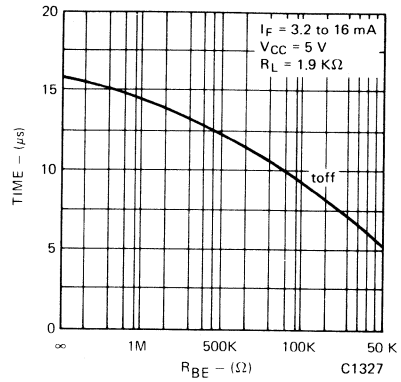


Fig. 10. Switch-off Time vs. Base to Emitter Resistance (saturated)

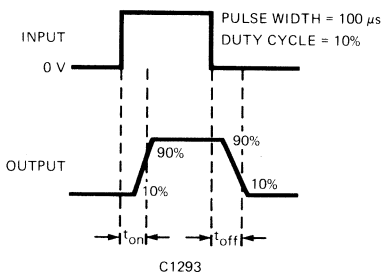


Fig. 11.

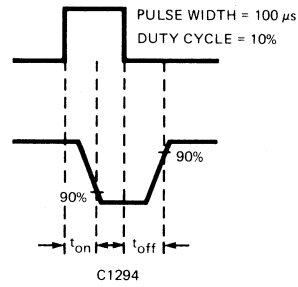


Fig. 12.

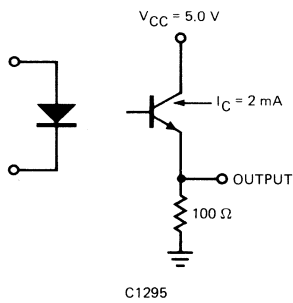


Fig. 13.

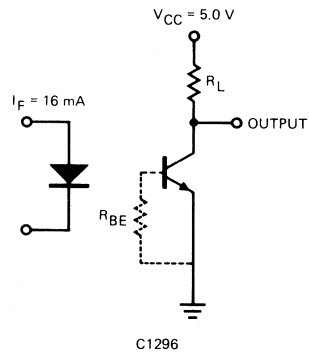


Fig. 14.

FEATURE SPECIFICATIONS

- 40% Transfer ratio at $V_{CE(SAT)}$ of 0.4 volts for multiple gate interface
- Temperature — stable from 0°C to 70°C
- Maximum Turn-on time — 15 μ seconds (specified condition)
- Maximum Turn-off time — 15 μ seconds (specified condition)
- Surge Isolation Rating —
2500 volts DC 1500 volts AC, rms
- Steady-state Isolation Rating —
1750 volts DC 1250 volts AC, rms
- Underwriters Laboratory (U.L.) recognized — File E50151

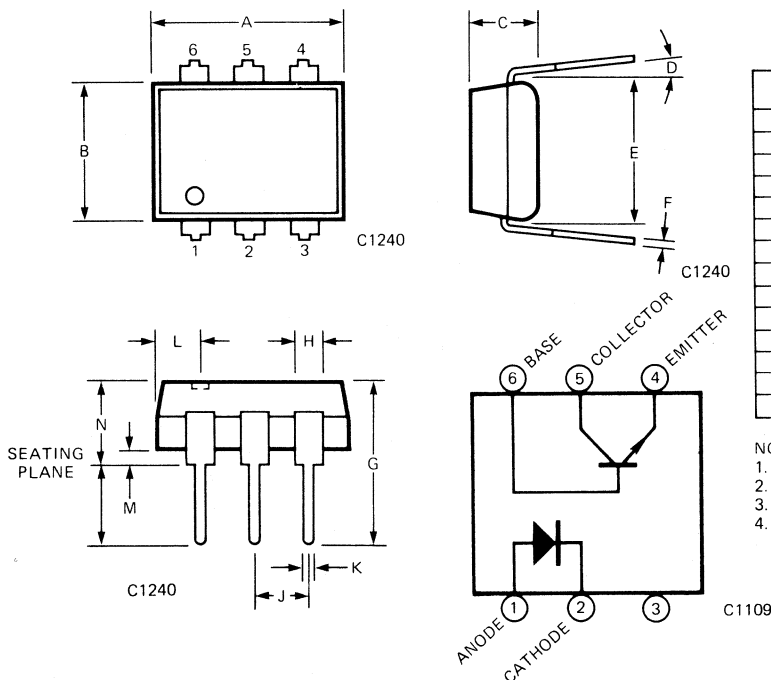
DESCRIPTION

The MCT277 is a phototransistor-type optically coupled isolator. An infrared emitting diode manufactured from specially grown gallium arsenide is selectively coupled with an NPN silicon phototransistor. The device is supplied in a standard plastic six-pin dual-in-line package.

APPLICATIONS

- Digital to digital system interface
- Sensor to many gates
- Ground loop isolation
- Power supply regulation

PACKAGE DIMENSIONS



SYMBOL	INCHES MAX.	mm MAX.	NOTES
A	.365	9.27	
B	.270	6.73	
C	.130	3.18	
D	15°	15°	
E	.300 Ref.	7.62 Ref.	1
F	.014	0.36	
G	.325	8.26	
H	.070	1.78	
J	.110	2.79	
K	.022	0.56	
L	.085	2.16	2
M			3
N	.175	4.45	4
P			3

- NOTES
1. INSTALLED POSITION OF LEAD CENTERS
 2. FOUR PLACES
 3. OVERALL INSTALLED POSITION
 4. THESE MEASUREMENTS ARE MADE FROM THE SEATING PLANE

ELECTRO-OPTICAL CHARACTERISTICS (0° to +70°C Temperature unless otherwise specified)

TRANSFER CHARACTERISTICS							
	CHARACTERISTICS	SYMBOL	MIN.	TYP.	MAX.	UNITS	TEST CONDITIONS
DC	Current Transfer Ratio, collector to emitter	I_{CE}/I_F	100			%	$I_F = 10 \text{ mA}; V_{CE} = 10 \text{ V}$
	Current Transfer Ratio, collector to base	I_{CB}/I_F	40	.4		%	$I_F = 16 \text{ mA}; V_{CE} = 0.4 \text{ V}$ $I_F = 10 \text{ mA}; V_{CB} = 10 \text{ V}$
SWITCHING TIMES	Non-saturated Turn-on time	t_{on}			15	μs	$R_L = 100 \Omega; I_C = 2 \text{ mA}; V_{CC} = 5 \text{ V}$
	Turn-off time	t_{off}			15	μs	See figures 15, 17
	Saturated Turn-on time	t_{on}		3.8		μs	$I_F = 16 \text{ mA}; R_L = 1.9 \text{ K}\Omega$
	Turn-off time (Approximates a typical TTL interface)	t_{off}		90		μs	See figures 16, 18
	Turn-on time	t_{on}		3.7		μs	$I_F = 16 \text{ mA}; R_L = 4.7 \text{ K}\Omega$
	Turn-off time (Approximates a typical low power TTL interface)	t_{off}		190		μs	See figures 16, 18
ISOLATION	Surge isolation	V_{iso}	2500			VDC	Relative humidity $\leq 50\%$, $T_A = +25^\circ\text{C}, I_{I-O} \leq 10 \mu\text{A}$
	Steady state isolation	V_{iso}	1500			VAC-rms	1 second
		V_{iso}	1750			VDC	Relative humidity $\leq 50\%$, $T_A = +25^\circ\text{C}, I_{I-O} \leq 10 \mu\text{A}$
	Isolation resistance	R_{iso}	1250			VAC-rms	1 minute
			10^{11}			ohms	$V_{I-O} = 500 \text{ VDC}, T_A = +25^\circ\text{C}$
	Isolation capacitance	C_{iso}		1.0		pF	$f = 1 \text{ MHz}$

INDIVIDUAL COMPONENT CHARACTERISTICS							
	CHARACTERISTIC	SYMBOL	MIN.	TYP.	MAX.	UNITS	TEST CONDITIONS
INPUT DIODE	Forward voltage	V_F		1.20	1.50	V	$I_F = 20 \text{ mA}$
	Forward voltage temp. coefficient			-1.8		mV/°C	
	Reverse breakdown voltage	BV_R	3.0	25		V	$I_R = 10 \mu\text{A}$
	Junction capacitance	C_J		50		pF	$V_F = 0 \text{ V}, f = 1 \text{ MHz}$
	Reverse leakage current	I_R		.35	10	μA	$V_F = 1 \text{ V}, f = 1 \text{ MHz}$ $V_R = 3.0 \text{ V}$
OUTPUT TRANSISTOR	DC forward current gain	h_{FE}	100	420			$V_{CE} = 5 \text{ V}, I_C = 100 \mu\text{A}$
	Breakdown voltage						
	Collector to emitter	BV_{CEO}	30	45		V	$I_C = 1.0 \text{ mA}, I_F = 0$
	Collector to base	BV_{CBO}	70	130		V	$I_C = 10 \mu\text{A}$
	Emitter to collector	BV_{ECO}	7	10		V	$I_C = 100 \mu\text{A}, I_F = 0$
	Leakage current						
	Collector to emitter	I_{CEO}		5	50	nA	$V_{CE} = 10 \text{ V}, I_F = 0,$ $T_A = +25^\circ\text{C}$
	Capacitance						
Collector to emitter			8		pF	$V_{CE} = 0, f = 1 \text{ MHz}$	
Collector to base			20		pF	$V_{CB} = 5, f = 1 \text{ MHz}$	
Emitter to base			10		pF	$V_{EB} = 0, f = 1 \text{ MHz}$	

ALL TYP. READINGS @ +25°C

ABSOLUTE MAXIMUM RATINGS

TOTAL PACKAGE

Storage temperature -55°C to 150°C
 Operating temperature -55°C to 100°C
 Lead temperature
 (Soldering, 10 sec) 260°C
 Total package power dissipation @ 25°C
 (LED plus detector) 260 mW
 Derate linearly from 25°C 3.4 mW/°C

INPUT DIODE

Forward DC current 60 mA
 Reverse voltage 3 V
 Peak forward current
 (1 μs pulse, 300 pps) 3.0 A
 Power dissipation 25°C 200 mW
 Derate linearly from 25°C 2.6 mW/°C

OUTPUT TRANSISTOR

Power dissipation @ 25°C 200 mW
 Derate linearly from 25°C 2.67 mW/°C

ELECTRICAL CHARACTERISTIC CURVES (25°C Free air temperature unless specified)

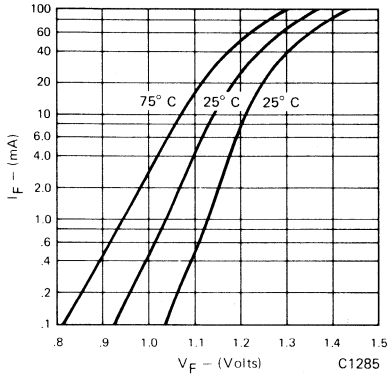


Fig. 1. Forward Voltage vs. Forward Current

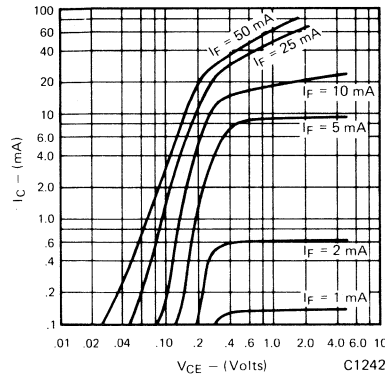


Fig. 2. Collector Current vs. Collector to Emitter Voltage

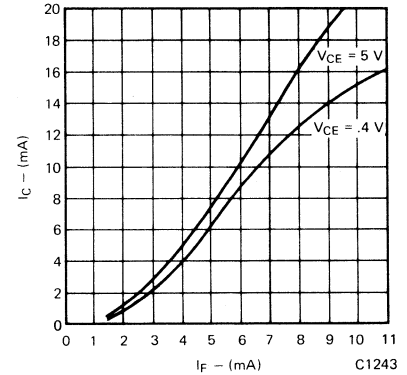


Fig. 3. Collector Current vs. Forward Current

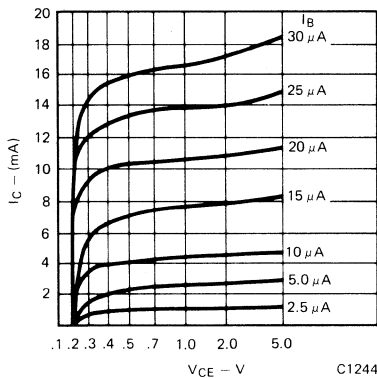


Fig. 4. Collector Current vs. Collector to Emitter Voltage

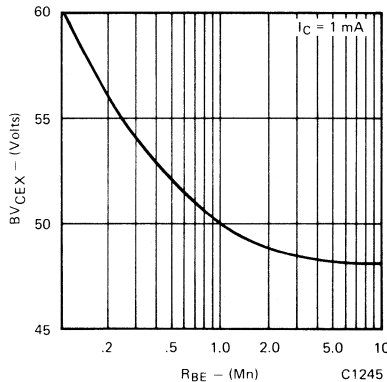


Fig. 5. Collector to Emitter Breakdown Voltage vs. Base to Emitter Resistance

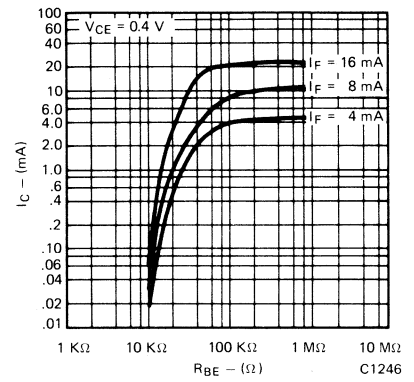


Fig. 6. Saturated CTR vs. Base to Emitter Resistance

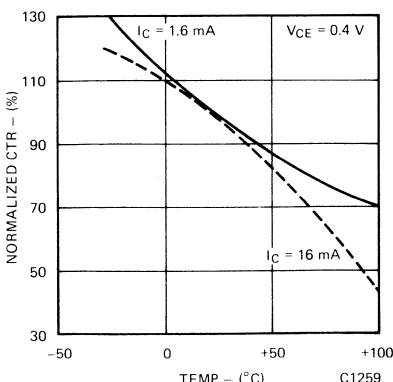


Fig. 7. Current Transfer Ratio (saturated) vs. Temperature

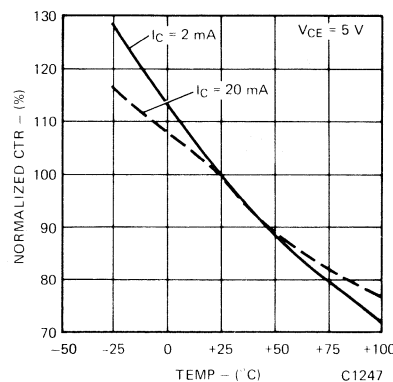


Fig. 8. Current Transfer Ratio (unsaturated) vs. Temperature

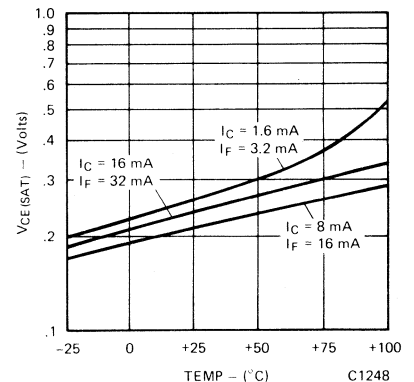


Fig. 9. Collector to Emitter Saturation Voltage vs. Temperature

ELECTRICAL CHARACTERISTIC CURVES (25°C Free air temperature unless specified)

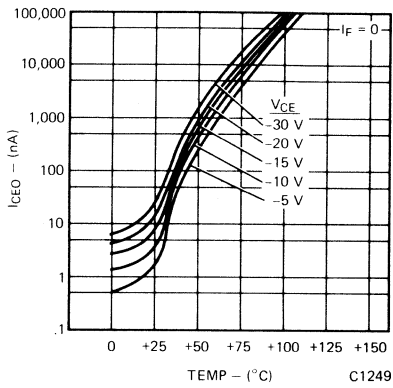


Fig. 10. Collector to Emitter Leakage Current vs. Temperature

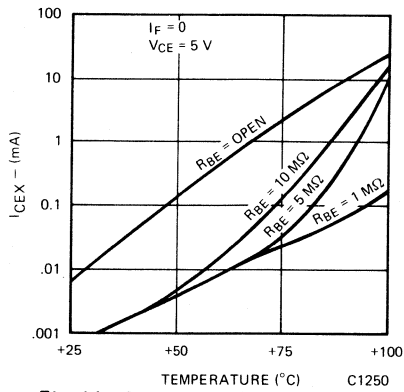


Fig. 11. Collector to Emitter Leakage Current vs. Temperature

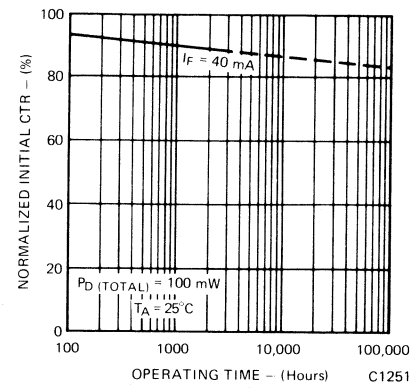


Fig. 12. Current Transfer Ratio vs. Operating Time

SWITCHING CHARACTERISTICS

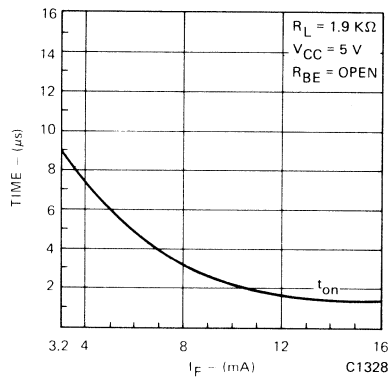


Fig. 13. Switch-on Time vs. IF Drive (saturated)

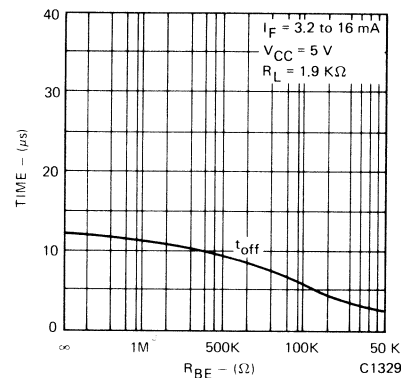


Fig. 14. Switch-off Time vs. Base to Emitter Resistance (saturated)

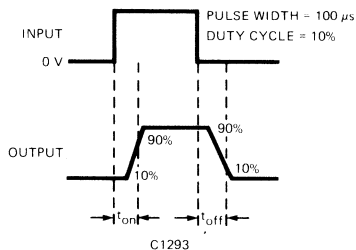


Fig. 15.

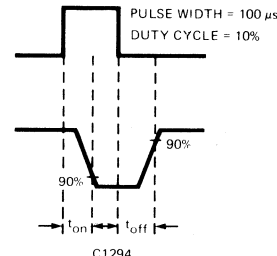


Fig. 16.

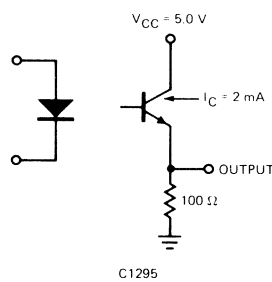


Fig. 17.

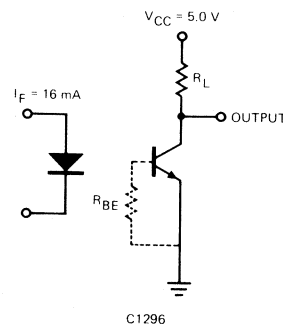


Fig. 18.

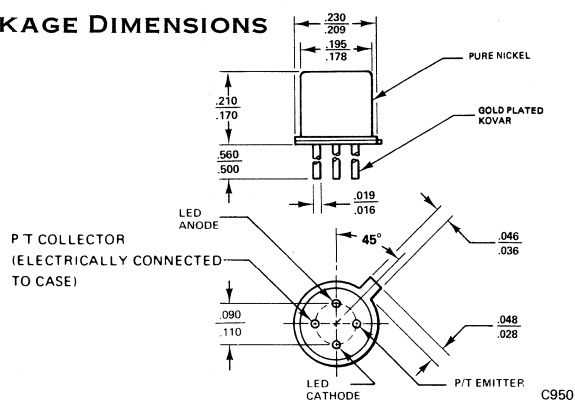
Monsanto

MCT4 PHOTOTRANSISTOR OPTOISOLATOR

PRODUCT DESCRIPTION

The MCT4 is a standard four-lead, TO-18 package containing a GaAs light emitting diode optically coupled to an NPN silicon planar phototransistor.

PACKAGE DIMENSIONS



FEATURES

- Hermetic package
- High current transfer ratio; typically 35%
- High isolation resistance; 10^{11} ohms at 500 volts
- High voltage isolation emitter to detector

ABSOLUTE MAXIMUM RATINGS

Storage temperature — -65°C to 150°C
 Operating temperature — -55°C to 125°C
 Lead soldering time @ 260°C — 10.0 seconds

LED (GaAs Diode)

Power dissipation @ 25°C ambient 60 mW
 Derate linearly from 25°C $0.6 \text{ mW}/^{\circ}\text{C}$
 Continuous forward current 40 mA
 Reverse voltage 3.0 volts
 Peak forward current 3.0 A
 (1 μs pulse, 300 pps)

DETECTOR (Silicon phototransistor)

Power dissipation @ 25°C ambient 190 mW
 Derate linearly from 25°C $1.9 \text{ mW}/^{\circ}\text{C}$
 Collector-emitter breakdown voltage
 (BV_{CEO}) 30 volts
 Emitter-collector breakdown voltage
 (BV_{ECO}) 7.0 volts
 ISOLATION VOLTAGE 1000 VDC

ELECTRO-OPTICAL CHARACTERISTICS (25°C Free Air Temperature Unless Otherwise Specified)

CHARACTERISTICS	MIN.	TYP.	MAX.	UNITS	TEST CONDITIONS
Emitter					
Forward voltage		1.3	1.5	V	$I_F=40 \text{ mA}$
Reverse current		.15	10	μA	$V_R=3.0 \text{ V}$
Capacitance		150		pF	$V=0$
Detector					
BV_{CEO}	30			V	$I_C=1.0 \text{ mA}, I_F=0$
BV_{ECO}	7	12		V	$I_C=100 \mu\text{A}, I_F=0$
I_{CEO} (Dark)		5	50	nA	$V_{\text{CE}}=10 \text{ V}, I_F=0$
Capacitance collector-emitter		2		pF	$V_{\text{CE}}=0$
Coupled					
DC current transfer ratio	15	35		%	$I_F=10 \text{ mA}, V_{\text{CE}}=10 \text{ V}$
Breakdown voltage	1000	1500		VDC	
Resistance emitter-detector	10^{11}	10^{12}		ohms	$V_{\text{E-D}}=500 \text{ V}$
$V_{\text{CE(SAT)}}$		0.1		V	$I_C=500 \mu\text{A}, I_F=10 \text{ mA}$
		0.2	0.5	V	$I_C=2 \text{ mA}, I_F=50 \text{ mA}$
Capacitance LED to detector		1.8		pF	
Bandwidth (see figure 5)		300		kHz	Note 2
Rise time and fall time (see operating schematic)		2		μs	$I_C=2 \text{ mA}, V_{\text{CE}}=10 \text{ V}$ Note 3

TYPICAL ELECTRO-OPTICAL CHARACTERISTIC CURVES
(25°C Free Air Temperature Unless Otherwise Specified)

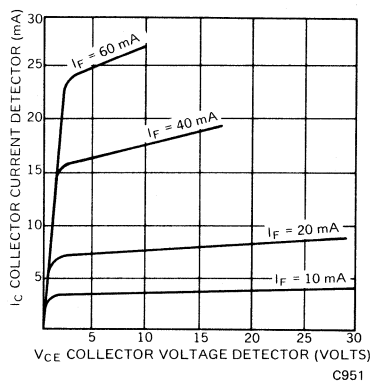


Figure 1 Detector Output Characteristics

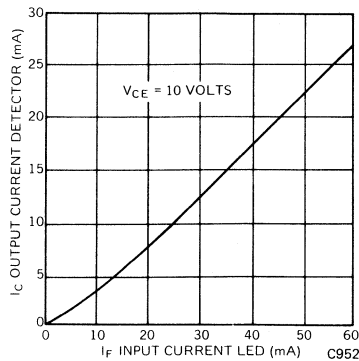


Figure 2 Input Current vs. Output Current

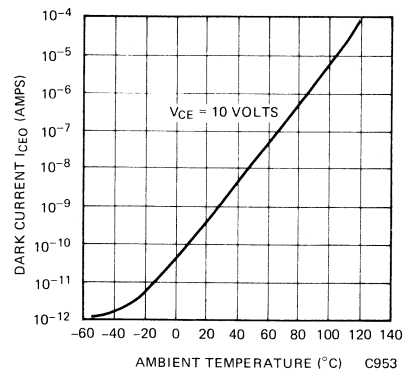


Figure 3 Dark Current vs. Temperature (°C)

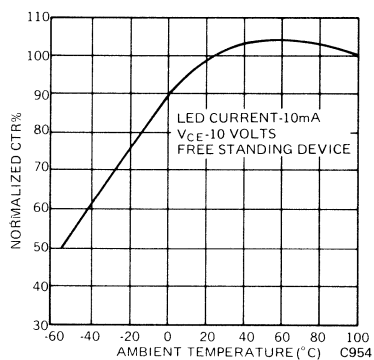


Figure 4 Current Output vs. Temperature

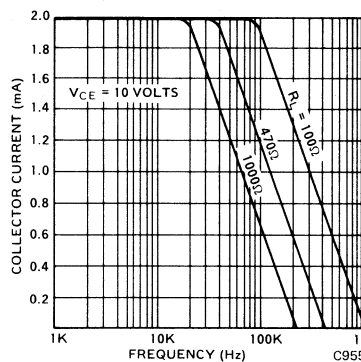


Figure 5 Output vs. Frequency

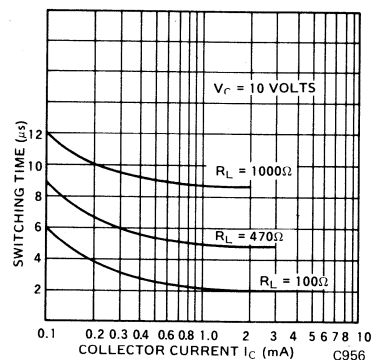
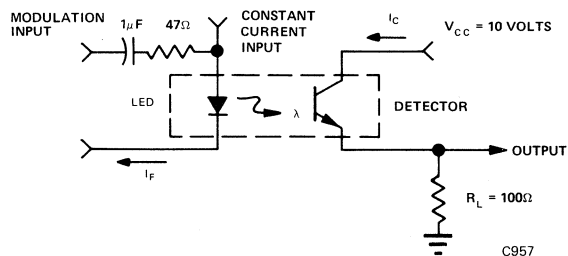


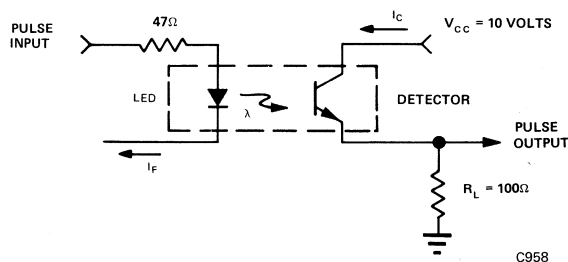
Figure 6 Switching Time vs. Collector Current

For additional characteristic curves, see MCT2

OPERATING SCHEMATICS



Modulation Circuit Used to Obtain Output vs. Frequency Plot



Circuit Used to Obtain Switching Time vs. Collector Current Plot

NOTES

1. The current transfer ratio (I_C/I_F) is the ratio of the detector collector current to the LED input current with V_{CE} at 10 volts.
2. The frequency at which i_c is 3 dB down from the 1 kHz value.
3. Rise time (t_r) is the time required for the collector current to increase from 10% of its final value, to 90%. Fall time (t_f) is the time required for the collector current to decrease from 90% of its initial value to 10%.

Monsanto

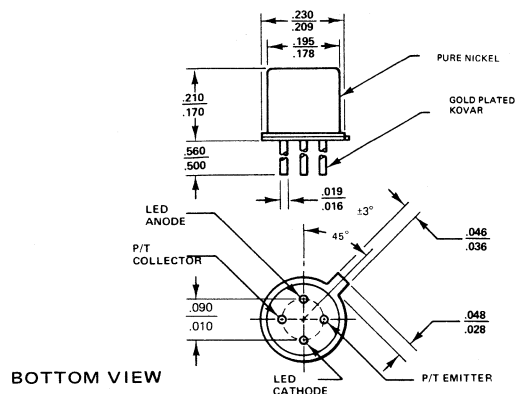
MCT4-R

RELIABILITY CONDITIONED PHOTOTRANSISTOR OPTOISOLATOR

PRODUCT DESCRIPTION

The MCT4 is a standard four-lead, TO-18 package containing a GaAs light emitting diode optically coupled to a silicon planar phototransistor.

PACKAGE DIMENSIONS



FEATURES

- Hermetic package
- High current transfer ratio; typically 35%
- High isolation resistance; 10^{11} ohms at 500 volts
- High voltage isolation emitter to detector

The Monsanto MCT 4R is designed and manufactured to conform to the requirements of military systems. Reliability testing has proven the product capable of conforming to the screening and quality conformance requirements of MIL-STD-883 Class B devices.

SCREEN — 100%

Characteristic	Method
Internal Visual	2010 — Characteristics applicable to device
Stabilization Bake	1008 — 150°C. for 48 hours
Temperature Cycle	1010 — 10 cycles; -55°C., 25°C., 150°C., 25°C.
Centrifuge	2001 — Test Condition E
Hermeticity	1014 — Fine and Gross
Critical Electrical	— Data Sheet
Burn In*	1015 — 168 hours @ 125°C.
Final Electrical	— Data Sheet
Group A Sample Inspection	5005 Table I Subgroups
External Visual	2009

LOT QUALIFICATION TESTS

Characteristic	Method	LTPD
Subgroup I		
Visual Mechanical		
Marking Permanency	2008	15%
Physical Dimensions		
Subgroup II		
Solderability	2003	15%
Subgroup III		
Thermal Shock	1011 –15 cycles; 150°C. to –65°C.	
Temperature Cycle	1010 –10 cycles; –55°C., 25°C., 150°C., 25°C.	15%
Moisture Resistance	1004	
Critical Electrical	– Data Sheet	
Subgroup IV		
Mechanical Shock	2002 – Condition B	15%
Vibration Fatigue	2005 – Condition A	
Vibration Variable Frequency	2007 – Condition A	
Constant Acceleration	2001 – Condition E	
Critical Electrical	– Data Sheets	
Subgroup V		
Lead Fatigue	2004 – Condition B ₂	15%
Hermeticity	1014 – Fine Condition A Gross Condition C	
Subgroup VI		
Salt Atmosphere	1009 – Condition A	15%

LIFE TESTING 7% LTPD

Subgroup VII		
High Temperature Storage	1008 – 150°C. for 1000 hours	7%
Critical Electrical	– Data Sheet	
Subgroup VIII		
Operating Life	1005 – Condition B	7%
Critical Electrical	– Data Sheets	
Subgroup IX		
Steady State Reverse Bias	1015 – Condition A; 72 hours at 150°C.	7%
Subgroup X		
Bond Strength	2001 –Condition C; 10 devices only	

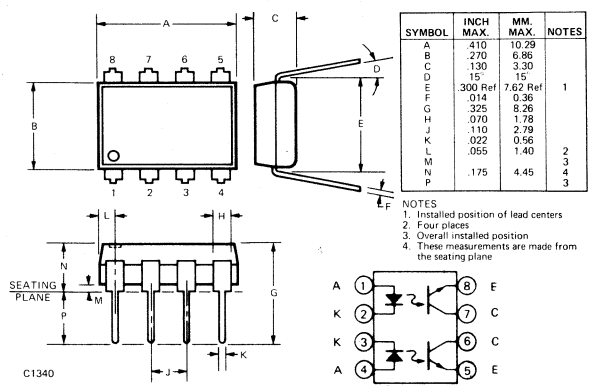
Reference: MIL-STD-883, Test Methods and Procedures for Microelectronics.

PRODUCT DESCRIPTION

The MCT6 opto-isolator has two channels for high density applications. For four channel applications, two-packages fit into a standard 16-pin DIP socket.

At the input, a GaAsLITE emitting diode generates infrared light proportional to current passing through the diode in the forward direction. At the output, a silicon phototransistor detects and amplifies the photocurrent generated in its photosensitive base region. Light coupling electrically isolates the input from the output.

PACKAGE DIMENSIONS



FEATURES

- Two isolated channels per package
- Two packages fit into a 16 lead DIP socket
- Same basic electrical characteristics as MCT2
- 1500 volt isolation
- 50% typical current transfer ratio

APPLICATIONS

- AC Line/Digital Logic Isolate high voltage transients
- Digital Logic/Digital Logic Eliminate spurious grounds
- Digital Logic/AC Triac Control Isolate high voltage transients
- Twisted pair line receiver Eliminate ground loop feedthrough
- Telephone/Telegraph line receiver Isolate high voltage transients
- High Frequency Power Supply
 Feedback Control Maintain floating ground
- Relay contact monitor Isolate floating grounds and transients
- Power Supply Monitor Isolate transients

ABSOLUTE MAXIMUM RATINGS

Storage Temperature -55°C to 150°C
 Operating Temperature -55°C to 100°C
 Lead Temperature (soldering, 10 sec.) 250°C

INPUT DIODE (each channel)
 Rated forward current, DC 60 mA
 Peak reverse current 10 μ A
 Peak forward current (1 μ s pulse, 300 pps) 3 A
 Power dissipation at 25°C ambient 100 mW
 Derate linearly from 50°C 2 mW/°C

OUTPUT TRANSISTOR (each channel)
 Power dissipation @ 25°C ambient 150 mW
 Derate linearly from 25°C 2 mW/°C
 Collector Current 30 mA
COUPLED
 Input to output breakdown voltage 1500 volts DC
 Total package power dissipation @ 25°C ambient 400 mW
 Derate linearly from 25°C 5.33 mW/°C

ELECTRO-OPTICAL CHARACTERISTICS (25°C Free Air Temperature Unless Otherwise Specified)

CHARACTERISTICS	MIN.	TYP.	MAX.	UNITS	TEST CONDITIONS
INPUT DIODE					
Rated forward voltage V_F		1.25	1.50	V	$I_F = 20$ mA
Reverse voltage V_R	3.0	25		V	$I_R = 10$ μ A
Reverse current I_R		.01	10	μ A	$V_R = 3.0$ V
Junction capacitance C_J		50		pF	$V_F = 0$ V
OUTPUT TRANSISTOR ($I_F = 0$)					
Breakdown voltage, collector to emitter BV_{CEO}	30	85		V	$I_C = 1.0$ mA
Breakdown voltage, emitter to collector BV_{ECO}	6	13		V	$I_C = 100$ μ A
Leakage current, collector to emitter I_{CEO}		5	100	nA	$V_{CE} = 10$ V
Capacitance collector to emitter C_{CE}		8		pF	$V_{CE} = 0$ V
COUPLED					
DC current transfer ratio (I_C/I_F) CTR	20	50		%	$V_{CE} = 10$ V, $I_F = 10$ mA
Isolation voltage $BV_{(I-O)}$	1500	2500		VDC	
Isolation resistance $R_{(I-U)}$	10^{11}	10^{12}		Ω	$V_{I-O} = 500$ VDC
Isolation capacitance $C_{(I-O)}$		0.5		pF	$f = 1$ MHz
Breakdown voltage — channel-to-channel		500		V	Relative humidity = 40%
Capacitance between channels		0.4		pF	$f = 1$ MHz
Saturation voltage — collector to emitter $V_{CE(SAT)}$.20	.40	V	$I_C = 2$ mA, $I_F = 16$ mA
Bandwidth B_W		150		kHz	$I_C = 2$ mA, $V_{CC} = 10$ V, $R_L = 100$ Ω

ELECTRO-OPTICAL CHARACTERISTICS (Con't)

CHARACTERISTICS	MIN.	TYP.	MAX.	UNITS	TEST CONDITIONS
SWITCHING TIMES, OUTPUT TRANSISTOR					$I_C = 2 \text{ mA}, V_{CE} = 10 \text{ V}, R_L = 100\Omega$
Non-saturated rise time, fall time		2.4		μs	$I_C = 2 \text{ mA}, V_{CE} = 10 \text{ V}, R_L = 1 \text{ K}\Omega$
Non-saturated rise time, fall time		15		μs	$R_L = 2 \text{ K}\Omega, I_F = 15 \text{ mA}$
Saturated turn-on time (from 5.0 V to 0.8 V)		5		μs	$R_L = 2 \text{ K}\Omega, I_F = 15 \text{ mA}$
Saturated turn-off time (from saturation to 2.0 V)		25		μs	

TYPICAL ELECTRO-OPTICAL CHARACTERISTIC CURVES (25°C Free Air Temperature Unless Otherwise Specified)

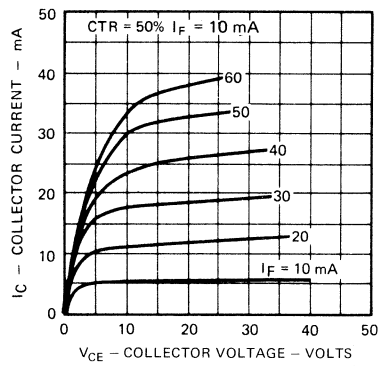


Figure 1 I-V Curve of Phototransistor

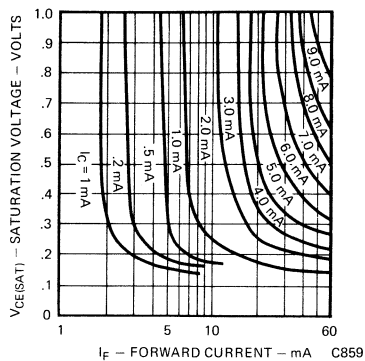


Figure 2 I-V Curve in Saturation

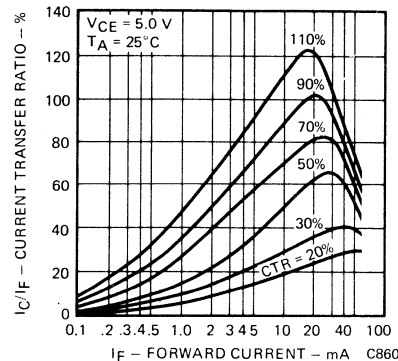


Figure 3 CTR vs. Forward Current

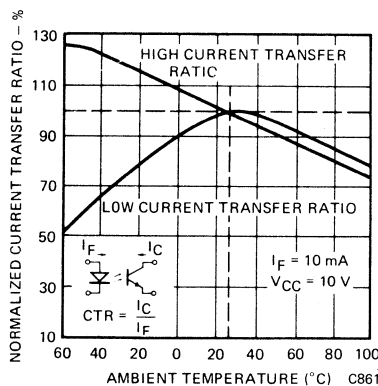


Figure 4 Current Transfer Ratio vs. Temperature

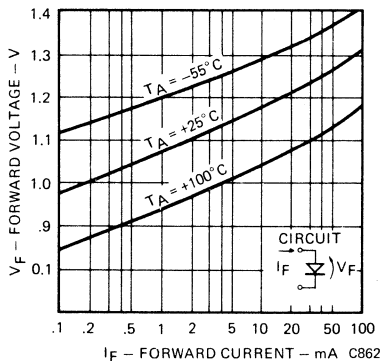


Figure 5 I-V Curve of LED vs. Temperature

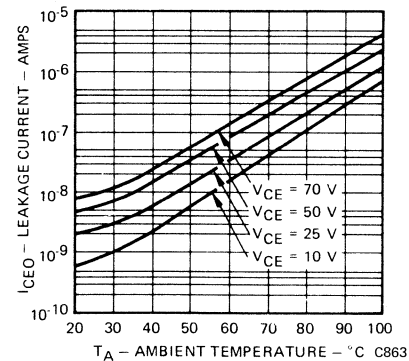


Figure 6 Leakage Current vs. Temperature vs. Collector Voltage

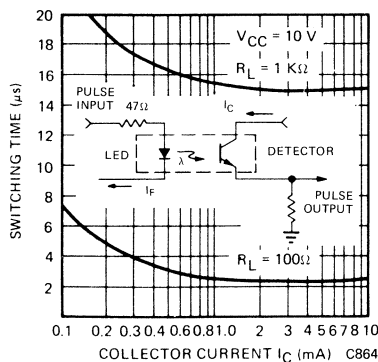


Figure 7 Switching Time vs. Collector Current

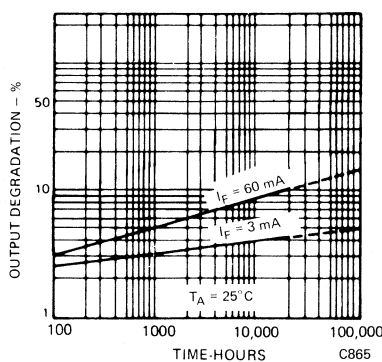


Figure 8 Lifetime vs. Forward Current (Note 1)

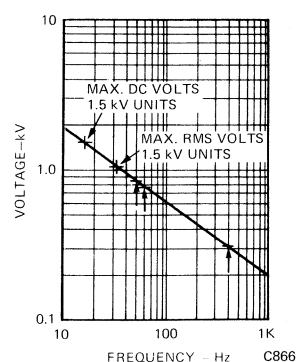


Figure 9 Steady-State AC Voltage Limit of Isolation Dielectric

NOTES

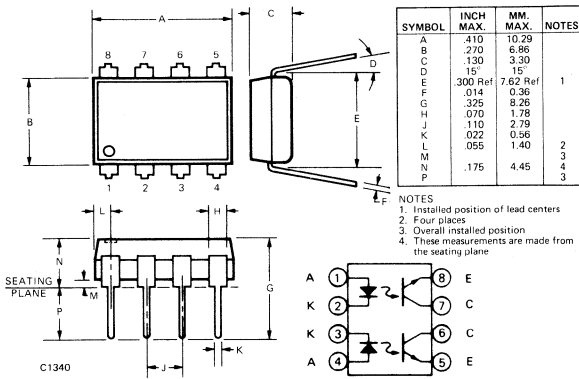
1. Normalized CTR degradation = $\frac{CTR_o - CTR}{CTR_o}$

PRODUCT DESCRIPTION

The MCT66 opto-isolator has two channels for high density applications. For four channel applications, two-packages fit into a standard 16-pin DIP socket.

At the input, a GaAsLITE emitting diode generates infrared light proportional to current passing through the diode in the forward direction. At the output, a silicon phototransistor detects and amplifies the photocurrent generated in its photosensitive base region. Light coupling electrically isolates the input from the output.

PACKAGE DIMENSIONS



FEATURES

- Two isolated channels per package
- Two packages fit into a 16 lead DIP socket
- Same basic electrical characteristics as MCT26
- 1500 volt isolation from non-repetitive surges
- 15% typical current transfer ratio

APPLICATIONS

- AC Line/Digital Logic Isolate high voltage transients
- Digital Logic/Digital Logic Eliminate spurious ground loops
- Digital Logic/AC Triac Control Isolate high voltage transients
- Twisted pair line receiver Eliminate ground loop pick-up
- Telephone/Telegraph line receiver Isolate high voltage transients
- High Frequency Power Supply Feedback Control Maintain floating ground
- Relay contact monitor Isolate floating grounds and transients
- Power Supply Monitor Isolate transients and ground systems

ABSOLUTE MAXIMUM RATINGS

Storage Temperature -55°C to 150°C
 Operating Temperature -55°C to 100°C
 Lead Temperature (soldering, 10 sec.) 250°C

INPUT DIODE (each channel)
 Rated forward current, DC 60 mA
 Peak reverse current 10 μA
 Reverse voltage 3.0 V
 Peak forward current (1 μs pulse, 300 pps) 3 A
 Power dissipation at 25°C ambient 100 mW
 Derate linearly from 50°C 2 mW/°C

OUTPUT TRANSISTOR (each channel)
 Power dissipation @ 25°C ambient 150 mW
 Derate linearly from 25°C 2 mW/°C
 Collector Current 30 mA

COUPLED
 Input to output breakdown voltage 1500 volts DC
 Total package power dissipation @ 25°C ambient 400 mW
 Derate linearly from 25°C 5.33 mW/°C

ELECTRO-OPTICAL CHARACTERISTICS (25°C Free Air Temperature Unless Otherwise Specified)

CHARACTERISTICS	MIN.	TYP.	MAX.	UNITS	TEST CONDITIONS
INPUT DIODE					
Rated forward voltage V_F	—	1.25	1.50	V	$I_F = 20 \text{ mA}$
Reverse voltage V_R	3.0	25	—	V	$I_R = 10 \mu\text{A}$
Reverse current I_R	—	.001	10	μA	$V_R = 3.0 \text{ V}$
Junction capacitance C_J	—	50	—	pF	$V_F = 0 \text{ V}$
OUTPUT TRANSISTOR ($I_F = 0$)					
Breakdown voltage, collector to emitter BV_{CEO}	30	85	—	V	$I_C = 1.0 \text{ mA}$
Breakdown voltage, emitter to collector BV_{ECO}	6	13	—	V	$I_C = 100 \mu\text{A}$
Leakage current, collector to emitter I_{CEO}	—	5	100	nA	$V_{CE} = 10 \text{ V}$
Capacitance collector to emitter C_{CE}	—	8	—	pF	$V_{CE} = 0 \text{ V}$
COUPLED					
DC current transfer ratio (I_C/I_F) = CTR	6	15	—	%	$V_{CE} = 10 \text{ V}, I_F = 10 \text{ mA}$
Isolation voltage $BV_{(I-O)}$	1500	2500	—	VDC	Peak from non-repetitive surges
Isolation resistance $R_{(I-O)}$	10^{11}	10^{12}	—	Ω	$V_{I-O} = 500 \text{ VDC}$
Isolation capacitance $C_{(I-O)}$	—	0.5	—	pF	$f = 1 \text{ MHz}$
Breakdown voltage — channel-to-channel	—	500	—	VDC	Relative humidity = 40%
Capacitance between channels	—	0.4	—	pF	$f = 1 \text{ MHz}$
Saturation voltage — collector to emitter $V_{CE} \text{ (SAT)}$	—	0.2	0.4	V	$I_C = 2 \text{ mA}, I_F = 40 \text{ mA}$
Bandwidth B_W	—	150	—	kHz	$I_C = 2 \text{ mA}, V_{CC} = 10 \text{ V}, R_L = 100 \Omega$

ELECTRO-OPTICAL CHARACTERISTICS (Con't)

CHARACTERISTICS	MIN.	TYP.	MAX.	UNITS	TEST CONDITIONS
SWITCHING TIMES, OUTPUT TRANSISTOR					
Non-saturated rise time, fall time (Note 3)		2.4		μ s	$I_C = 2$ mA, $V_{CE} = 10$ V, $R_L = 100 \Omega$
Non-saturated rise time, fall time (Note 3)		15		μ s	$I_C = 2$ mA, $V_{CE} = 10$ V, $R_L = 1$ k Ω
Saturated turn-on time (from 5.0 V to 0.8 V)		5		μ s	$R_L = 2$ k Ω , $I_F = 40$ mA
Saturated turn-off time (from saturation to 2.0 V)		25		μ s	$R_L = 2$ k Ω , $I_F = 40$ mA

TYPICAL ELECTRO-OPTICAL CHARACTERISTIC CURVES (25°C Free Air Temperature Unless Otherwise Specified)

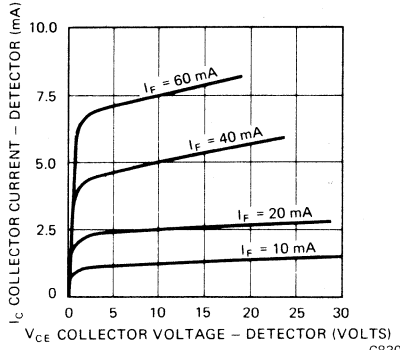


Fig. 1. Detector Output Characteristics C830

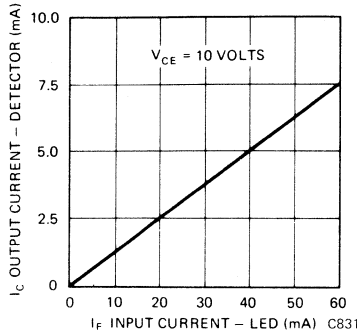


Fig. 2. Input Current vs. Output Current C831

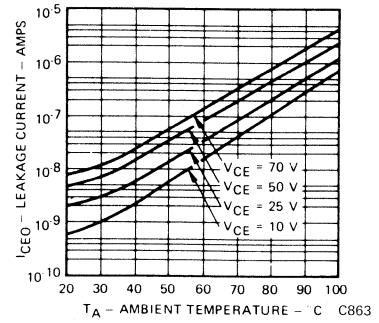


Fig. 3. Leakage Current vs. Temperature vs. Collector Voltage C863

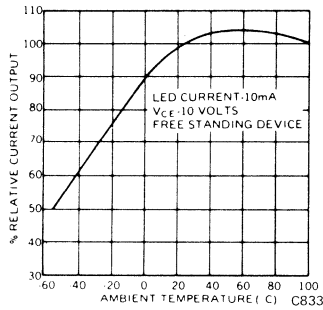


Fig. 4. Current Output vs. Temperature C833

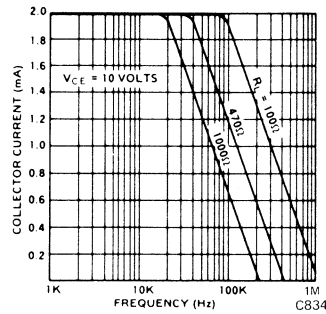


Fig. 5. Output vs. Frequency C834

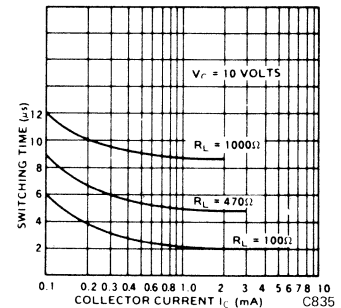


Fig. 6. Switching Time vs. Collector Current C835

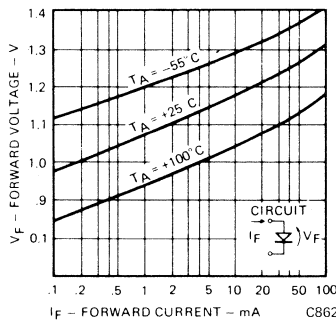


Fig. 7. I-V Curve of LED vs. Temperature C862

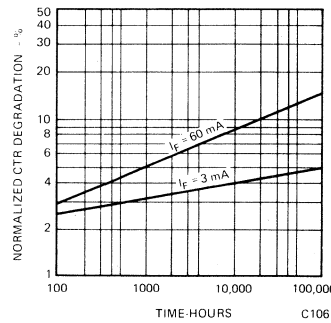
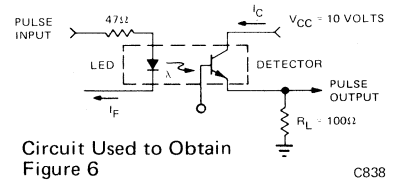
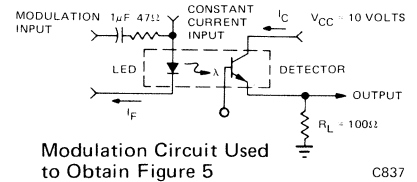


Fig. 8. Lifetime vs. Forward Current C1061

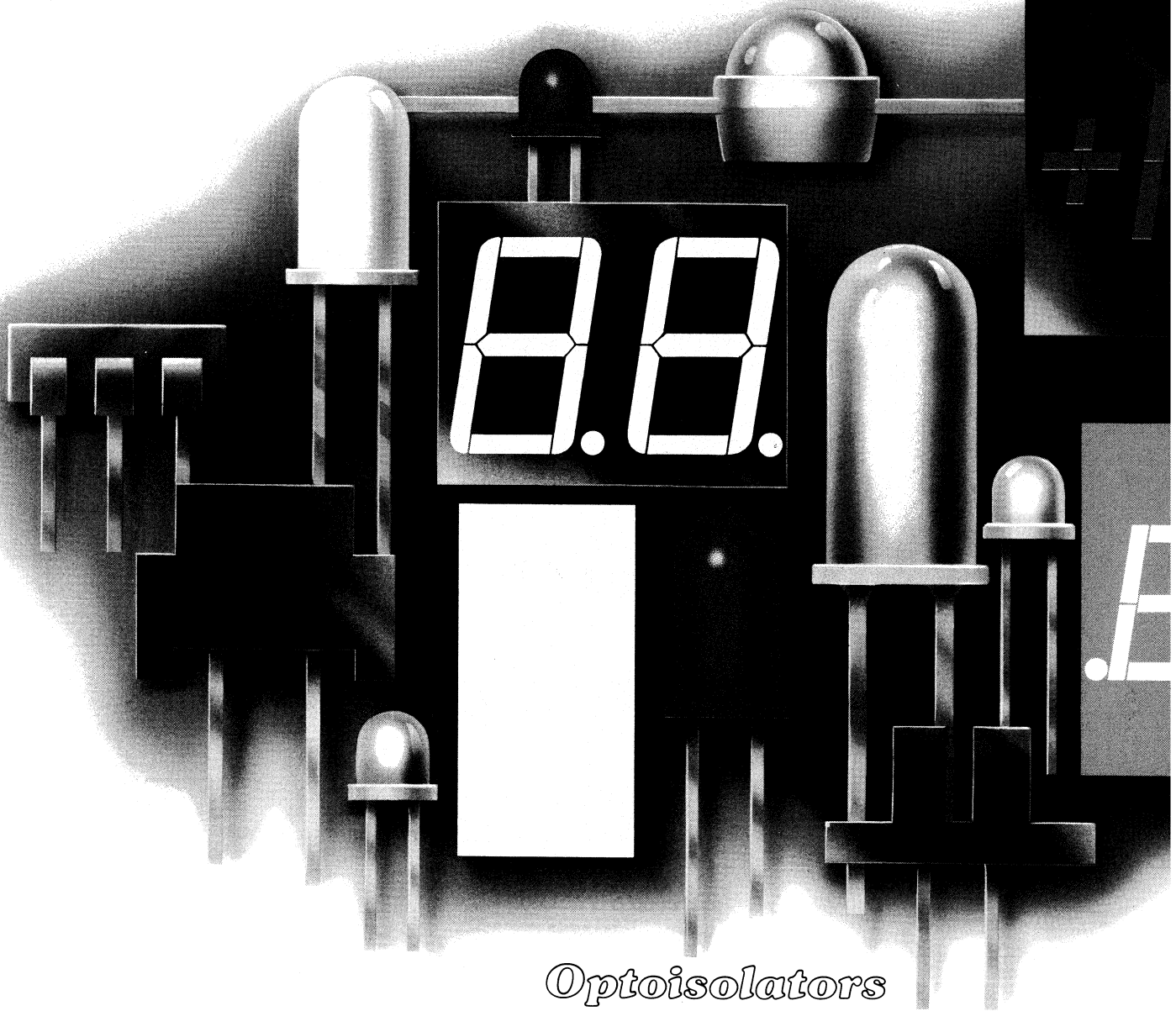


NOTES

1. The current transfer ratio (I_C/I_F) is the ratio of the detector collector current to the LED input current with V_{CE} at 10 volts.
2. The frequency at which i_c is 3 dB down from the 1 kHz value.
3. Rise time (t_r) is the time required for the collector current to increase from 10% of its final value to 90%.
Fall time (t_f) is the time required for the collector current to decrease from 90% of its initial value to 10%.

Displays

Discrete LED Lamps



Optoisolators